

Monitoring System of Agriculture Fields using ZigBee Modules

Odgerel Ayurzana*, Sugir Tsagaanchuluun**

** Department of Electronics, Mongolian University of Science and Technology, Professor, Mongolia*

*** Department of Electronics, Mongolian University of Science and Technology, Doctor (Dr.), Mongolia*

odgerel55@must.edu.mn, sugir@must.edu.mn

Abstract

The goal of this study is to develop experiment monitoring system of agriculture fields using ZigBee wireless modules. Soil moisture, ambient temperature, atmospheric pressure and intensity of sunlight are the most important factors to grow a wheat crop and other vegetables. In order to monitor the factors soil moisture (YL69), air pressure (BMP180), temperature (DS18B20), photoresistor were used for sensing environment data. The TI CC2530 RF SoC chip was used in the system. ZigBee modules were connected to star topology. ZigBee modules send data wirelessly to a data center. This data can be displayed and analyzed on the main monitoring program as needed also sent to the client mobile. Characteristics of the sensors were determined by experiment results.

Keywords: *sunlight intensity, soil moisture, atmospheric pressure, temperature.*

1. Introduction

As a result of overdevelopment of food technology, an international study proves that decontamination of foodstuff induced by poisonous fertilizer affects human health harmfully [1]. Therefore, biology product is essential to live healthy. In 2008, Mongolian government implemented “The III Cultivate Campaign” to protect health of population, secondly, support domestic economy. Due to a consequence of this program, investment in agriculture sector has been raised by 232 percent, constitute 1.4 in total Mongolian investment.

There are 2 times of growth in output of plantation between 2007 and 2013, reaching at 520 billion MNT. Though price of importing flour was 54680\$, it decreased as time went, falling at 6012.8 in 2015. Furthermore, there is promising demand in product of plantation. Farmers, yet, adopted supervisory irrigation system for the reason of global warming decrease output of plantation excessively for the last several years. For instance, vegetables grown per a hectare was 121.7 quintal in 2014 where as it was 115.2 quintal in 2015. Unfortunately, the size of crop per a hectare in yield with natural drainage was 5.6 quintal since suffering from extreme drought, though it with was 16.6 quintal in 2014 [2]. As an observation, it is necessary to implement supervisory irrigation system [3].

To automate this system, therefore, monitoring mechanism must be capable of defining field condition accurately. Nowadays, most of electronics systems have been shifting from wired to wireless technology. There are many technological and economic advantages in wireless technology. The RF, Bluetooth, UWF and ZigBee, short range wireless communication protocols and standards have been developed and used these days. However, the ZigBee is widely used throughout the world.

ZigBee technology is designed to meet compliance of compliant with IEEE 802.15.4 standard and it has to be inexpensive, energy efficient, and small physical dimensions of wireless nodes [4]. Also, its network topologies can be Star (1:1), Cluster tree (1: n) and Mesh (1: n). Data communication protocol is very simple; data rate is up to 250Kbps and the maximum number of nodes in the network is 65,536 [5]. A node means a ZigBee module. ZigBee's standard protocol versions have been developed named as ZigBee 2006, 2007 and PRO. There are three types of ZigBee modules.

- 1) ZigBee Coordinator - ZC
- 2) ZigBee Router - ZR
- 3) ZigBee End Device - ZED

The ZC is a general coordinator of network. There is a unique ZC in the network. ZR routes data from module to module and it is used when network expands. ZED transmits data of the attached sensors to data center through ZR and ZC.

Data transmission distance of the ZigBee module is 100m ~ 1000m it is depended on the antenna types, external case and sizes. In our experiment, where dipole antennas look at each other (open side), the distance was 1000 meters. In the same environment, we replaced the antennas with chip antenna and the distance decreased to 150 meters. In our case, the chip antennas were used in the experiment.

The present papers develop a smart wireless sensor network (WSN) for an agricultural environment [6, 7]. This investigates the development of a low-cost remote soil moisture monitoring system by deploying sensors, which can be used in a Zigbee mesh network [8].

1.1 Factors in wheat growth

There are considerable factors in wheat growth and, besides, soil quality.

Table 1. Effects on wheat growth

Factors	Influence
Soil moisture	Various growth stages and water requirements of the crop in order to achieve maximum yield and quality
Ambient temprature	The result of monitoring temperature differential, it is able to control the process of wealth growth, also increase risk of crop failure
Atmospheric pressure	Air pressure variation impact the soil moisture extremely
Sunlight intensity	One of the important affections in crop quality
UV radiation	Factor affecting plant growth

Hence, crop yield monitoring system frequently measure and report the following lists of parameters for 24 hours throughout growing season.

- ✓ Relative soil moisture
- ✓ Air temperature
- ✓ Atmospheric pressure
- ✓ Sunlight intensity

2. Design and solution of system

2.1 System structure

Figure 1 shows the basic diagram of system. Each ZED device measures own cover area's temperature, atmosphere pressure, soil moisture and intensity of sunlight, then transmits to the data center. All monitoring nodes measure temperature, pressure, moisture and intensity of sunlight. Monitoring nodes are connected to star topology. Any nodes, thus, is allowed to transmit attached sensors data to the data center through its nearest node. The data center is located in central establishment. ZigBee Coordinator (ZC) combines monitoring nodes data send to the database of the data center frequently via GSM modem. Not only yield status information is sent to guarantor's mobile but also, they able to check it in mobile whenever they want.

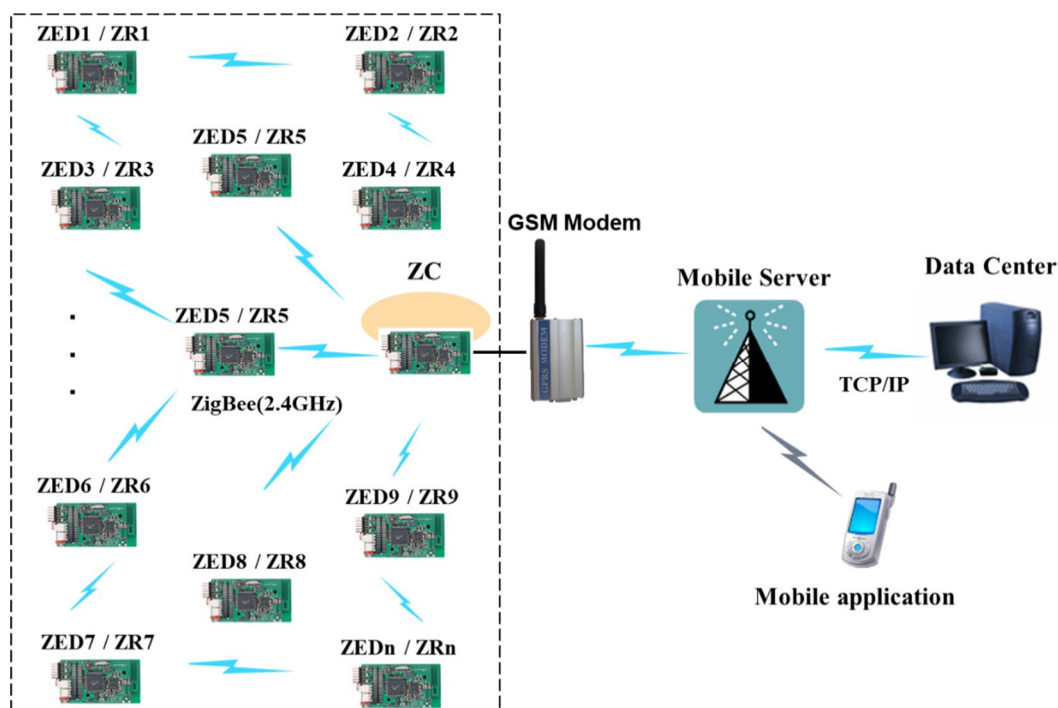

Figure 1. Main operation diagram of the system

2.1 Structure of one monitoring node

As counting 70x70m area as per unit area, one module is installed in (each) per unit area. Figure 2 shows the structure of ZigBee module of per unit nodes.

Monitoring node is based on CC2530 ZigBee SoC. It connects to DC power with a controller, analog module including light intensity and soil moisture sensors, digital module, air pressure and a temperature sensor. The monitoring nodes are powered by a battery is self-sufficient.

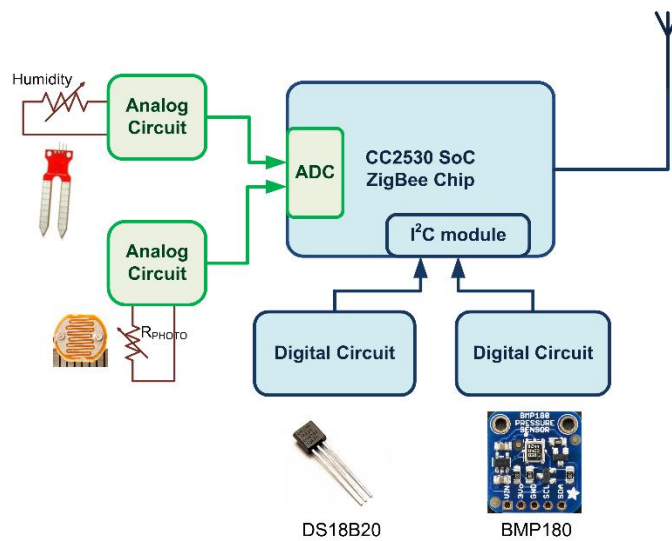

Figure 2. Structure diagram of one monitoring node

3. Experiment and result

3.1 Devices and sensors used in experiment

As shown in Figure 3, one of ZC (ZigBee Coordinator), three of ZED (ZigBee End Device) modules are connected in star topology. All of ZED frequently transmit measurement data of its attached sensors to ZC. ZC connects to the data center directly. ZC collects ZigBee nodes' data then sends to the main monitoring program. The monitoring program is displayed each ZigBee nodes data separately.

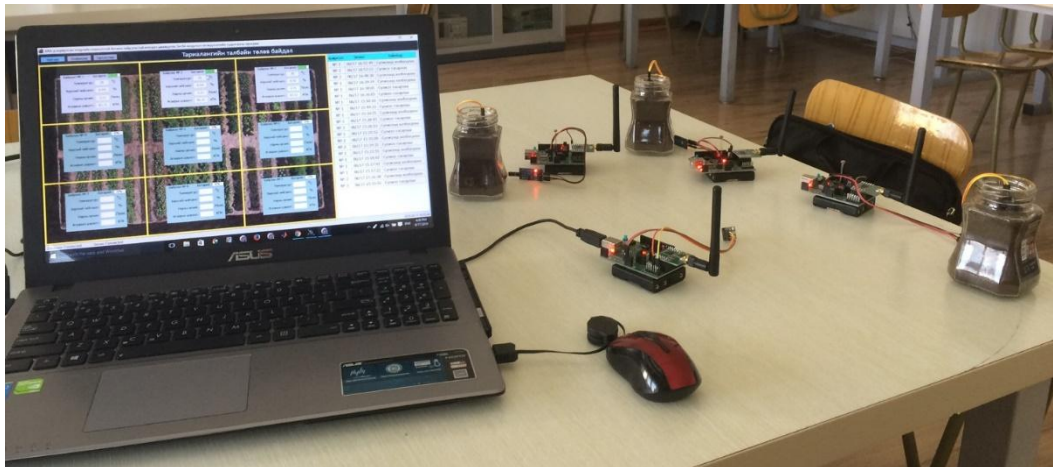

Figure 3. Real diagram of experiment

3.2 Measuring soil moisture

YL-69 series resistive sensor is used in an experiment. We measure and calibrate sensors output voltage at the same time pouring water on two different soils, predetermined moisture, of which weight is constant. In addition, the water component is determined according to Mongolian statistical standard MNS2143:2000. Result of experiment that performed in soil of propagator and field, is shown in table 2.

Table 2. Measurement of soil moisture content sensor for determining characteristic

№	Sensor output [V]		Soil weight [gm]	Weight of water in the soil [gm]	Moisture in percentage [%]
	After irrigation	After equal moisture distribution			
1	2.74	2.74	2735	136.58	5.6
2	1	1.35	2830	231.58	9.4
3	0.95	0.76	2915	316.58	12.9
4	0.47	0.54	3010	411.58	16.7
5	0.48	0.3	3105	506.58	20.6
6	0.22	0.21	3205	606.58	24.7
7	0.16	0.13	3305	706.58	28.7
8	0.16	0.09	3405	806.58	32.8
9	0.05	0.08	3500	901.58	36.7

Sensor characteristic are determined and calibrated in both of field and soil that is sampled from hotbed. Mathematical model of soil moisture sensor is found equation (1) with $R^2 = 0.9816$ coefficient and figure 4 shows relationship between output voltage and model.

$$y = 10.717x^{-0.501} \quad (1)$$

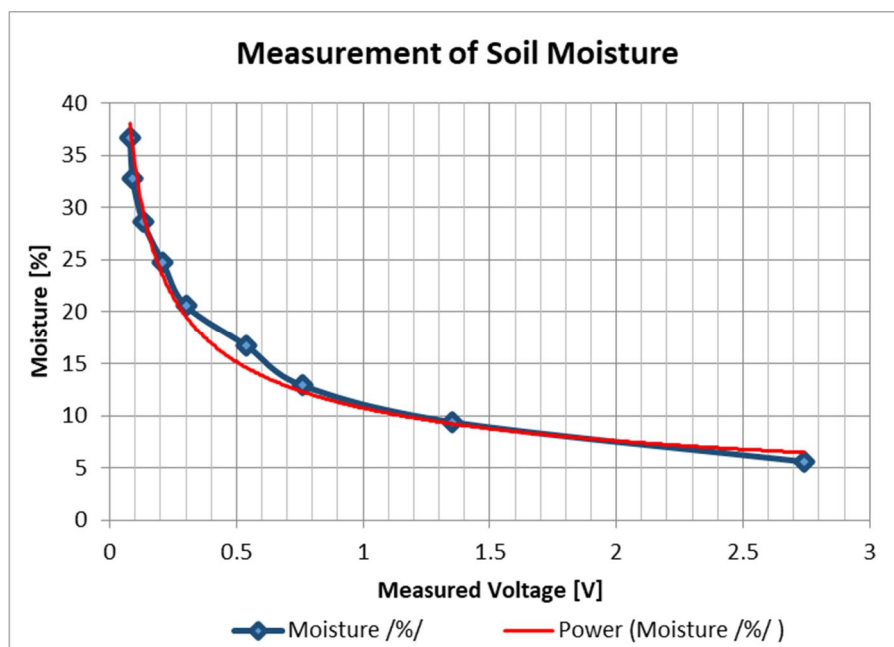
**Figure 4. Characteristic of soil moisture sensor**

3.3 Measuring light intensity

Analog circuit is consisting of photocells of three different surfaces, is used to measure solar radiation that is determined by lux meter. The table 3 shows the relationship between the resistance of the photocell and the illumination.

Intensity of sunlight is an important factor in a plant growth. Illumination is greater than 20,000 Lux when the sky is entirely clear, whereas is less than 5,000 Lux on a cloudy day.

Table 3. The relation between resistance and the illumination

No	Resistance [Ω]	Output Voltage [V]	Illumination [Lux]
1	122423.5	0.17	2
2	43573.33	0.45	10
3	8372.353	1.7	50
4	5814.085	2.13	80
5	5404.054	2.22	100
6	4248.81	2.52	150
7	3798.872	2.66	200
8	2092.582	3.37	500
9	1339.529	3.82	800
10	1072.319	4.01	1000
11	768.9412	4.25	1600
12	541.1236	4.45	2000
13	455.6291	4.53	2500
14	332.9032	4.65	3000
15	303.2051	4.68	3500
16	283.617	4.7	5000

Mathematical model of photoresistor is defined equation (2) with $R^2 = 0.9853$ coefficient and figure 5 shows relationship between the output voltage and model.

$$y = 3.212e^{1.487x} \quad (2)$$

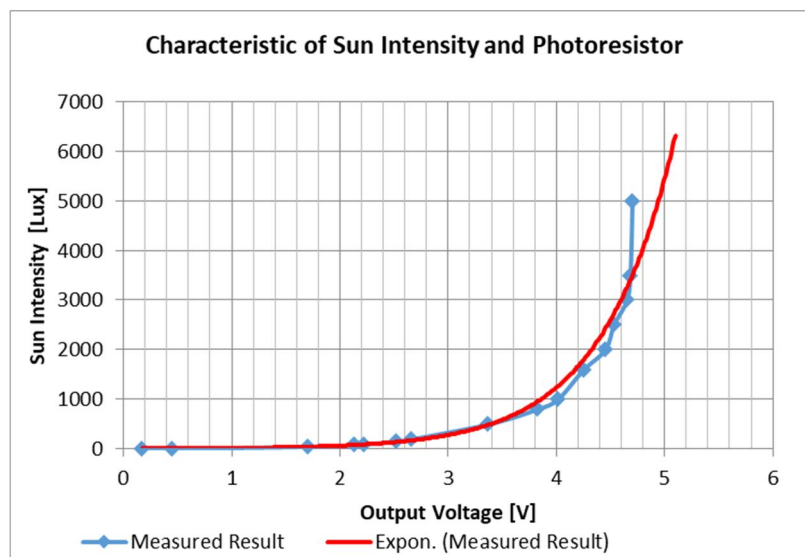
**Figure 5. Experimental characteristic of the sun light intensity**

3.4 Monitoring application program

Figure 6 shows the application software interface intended to monitor and control the system. Monitoring areas are divided to the cover area of one ZigBee end node. All sensors values and systems states are stored in the database.

As shown in figure, sensors data of Zigbee nodes installed in each unit area are displayed on the screen. If

a sensor values exceed the permissible level, the system will be alerted.

Also monitoring program will inform the expiration of battery of the ZigBee nodes.

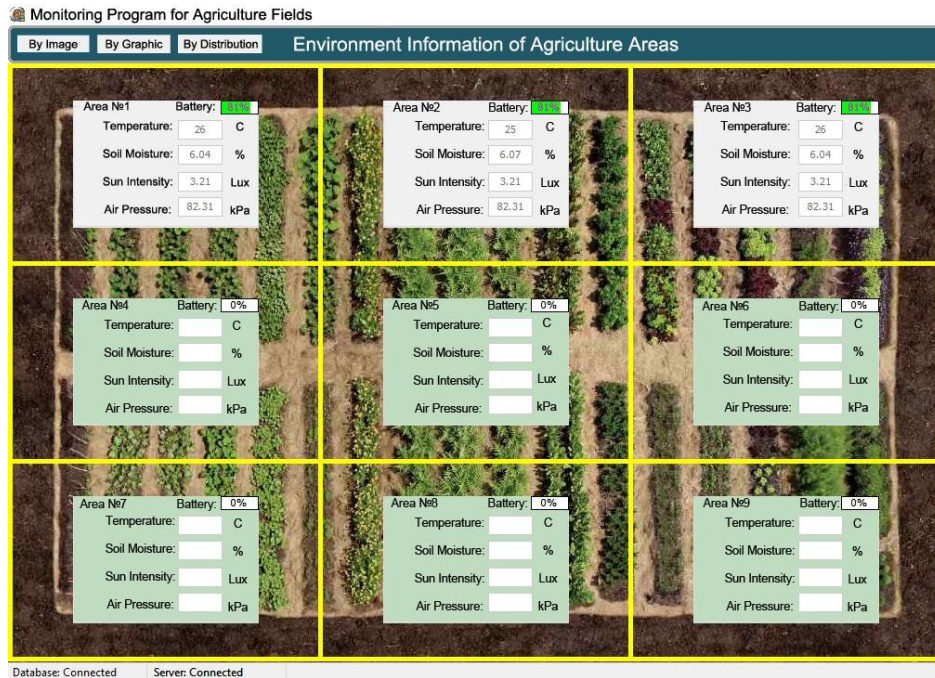

Figure 6. Screenshot of monitoring program

Figure 7 shows a function interface of the monitoring program. Each ZigBee nodes' environment data are visualized by graphics.

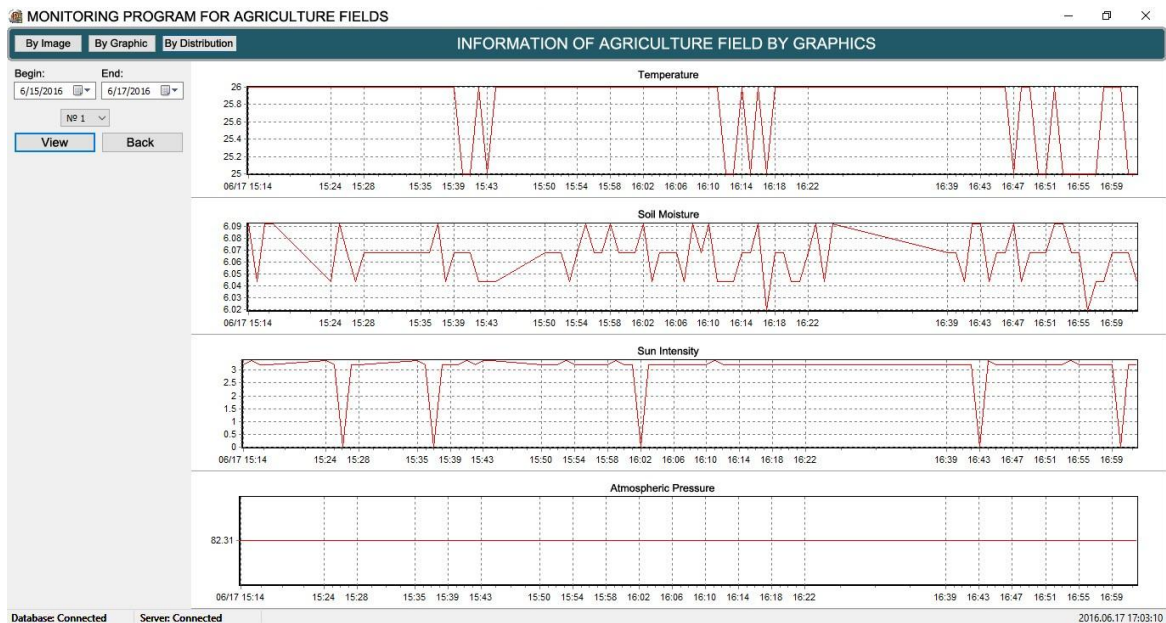

Figure 7. Graphics by all sensors values

Furthermore, all sensor data and system status are saved in database, which is able to view statistic

information and print out the report in a variety of ways.

4. Conclusion

Monitoring system of agriculture fields using ZigBee module with the CC2530 SoC was developed and experimented. Soil moisture, air pressure, ambient temperature and sunlight intensity sensors were connected to ZigBee end nodes for sensing environment data. In experiment, ZigBee modules were connected to star topology.

ZigBee end nodes send its own sensing data wirelessly to a ZigBee Coordinator (ZC). ZC sends to the data center, which collects the data, stores it and allows it to be analyzed. This data can be displayed on the main monitoring program as needed. Connecting wireless module with soil moisture and photocell sensors and performing, consequently each characteristic was determined.

In next stage of study, saving energy consumption of ZigBee nodes and, technical and routing algorithm will be researched for mesh network. By developing and implementing this system, it is able to monitor growth stage and previously plan the arrangement as well as preventing crop failure. Also, system have to implement and experiment to the real agriculture areas. In order to monitor big agriculture fields, it is necessary to apply the Zigbee mesh network.

References

- [1] "Food security" national program <http://www.legalinfo.mn/annex/details/2477?lawid=5415>
- [2] Potential Resource of the irrigation. The Ministry of Industry and Agriculture (MIA) <http://mofa.gov.mn>
- [3] The Mongolian statistical information service <http://www.1212.mn>
- [4] Sinem Coleri Ergen, *ZigBee/IEEE 802.15.4 Summary*, Sep 10, 2004.
- [5] ZigBee Alliance, Network Specification Version 1.0, Dec 2004.
- [6] Sumit P. Goyal, Dr. Archana Bhise, "Zigbee Based Real-Time Monitoring System of Agricultural Environment", *International Journal of Engineering Research and Applications* Vol.4, Issue 2, Feb 2014,
- [7] R. K. Moje, Komal Aundhe, Supriya Birajdar, "A ZigBee based Smart Wireless Sensor Network for Monitoring an Agricultural Environment", *IJARIE*, Vol. 3, Issue 2, 2017
- [8] Aqsa Mahir, Tanmay Banavalikar, Mayuresh Budukh, Soham Dhodapkar "Soil Monitoring System using ZigBee for Smart Agriculture", *International Journal of Science Technology & Engineering* Vol. 4, Issue 7, Jan 2018