

# A Passive Lossless Soft-Switching Single Inductor Dual Buck Full-Bridge Inverter

Feng Hong<sup>†</sup>, Yu Wu<sup>\*</sup>, Zunjing Ye<sup>\*\*</sup>, Baojian Ji<sup>\*\*</sup>, and Yufei Zhou<sup>\*</sup>

<sup>†,\*</sup>College of Electronic and Information Engineering, Nanjing University of Aeronautics and Astronautics, Nanjing, China

<sup>\*\*</sup>College of Electrical Engineering and Control Science, Nanjing TECH University, Nanjing, China

## Abstract

A novel passive lossless soft-switching single inductor dual buck full-bridge inverter (PLSSIDBFBI) is presented in this paper. To accomplish this, a passive lossless snubber circuit is added to a dual buck full-bridge inverter. Therefore, the advantages of the dual buck full-bridge inverter are included in the proposed inverter, and the inverter has just one filter inductor, which can decrease the system volume and improve the integration. In addition, the passive lossless snubber circuit achieves soft-switching by its own resonance, and all of the energy stored in the passive lossless snubber circuit can be transferred to load. A comparison between eight topologies is performed in this paper, and the analysis shows that the proposed soft-switching inverter topology has high reliability and efficiency. Finally, experimental results obtained with a 1 kW prototype verify the theoretical analysis and demonstrate the prominent characteristics of a reduced switching loss and improved efficiency.

**Key words:** Dual buck, High efficiency, High reliability, Passive lossless, Single inductor, Soft-switching

## I. INTRODUCTION

In recent years, transformerless photovoltaic (PV) grid-connected inverters have drawn a lot of attention for use in distributed PV power generation systems due to their low cost, compact structure, high reliability and high conversion efficiency [1]-[4]. The study of transformerless PV grid-connected inverters always focuses on optimizing the topology and improving reliability on the premise of guaranteeing the high-efficiency advantage of transformerless PV grid-connected inverters. With the continuous increase in the requirements for conversion efficiency, improving the switching frequency of power switching devices to downsize the filter and improve the power density has become the inevitable choice for transformerless PV grid-connected inverters. However, with the growing demands on the frequency of power electronic equipment, the switching losses of power devices have become an increasingly

prominent problem. An efficient approach to solve the switching dissipation problem and to improve system efficiency is to use soft-switching techniques [5], [6]. The concept of the soft switching technique for inverters was first proposed by Dr. Divan [7]. After years of development, they can be classified into resonant link dc-ac inverters, resonant transition dc-ac inverters, and load resonant dc-ac inverters<sup>[8]-[10]</sup>. Based on the availability of auxiliary switching devices, soft-switching technology can be divided into two categories: active soft-switching and passive soft-switching. The authors of [11] used a coupled-magnetic structure as the auxiliary resonant snubber circuit to achieve zero-voltage switching (ZVS). The auxiliary devices are low current and low cost IGBTs and diodes, which have low conduction and switching losses. The authors of [12]-[14] proposed ZCT-H6-I, ZVT-H6-I and SLF-H6-I active soft-switching transformerless inverters, which were developed from the H6 topology. In these topologies, the switching losses in the switches and diodes have been decreased based on the perfect leakage current suppression performance. The ZVT-HERIC active soft-switching transformerless inverter was presented in [15], by integrating resonant tanks and freewheeling switches. The zero voltage transition (ZVT) for all of the high-frequency switches and auxiliary switches

Manuscript received Aug. 3, 2017; accepted Oct. 21, 2017

Recommended for publication by Associate Editor Chun-An Cheng.

<sup>†</sup>Corresponding Author: hongfeng@nuaa.edu.cn

Tel: +86-025-84892840, Fax: +86-025-84892840,

Nanjing University of Aeronautics and Astronautics

<sup>\*</sup>Col. Electron. Inform. Eng., Nanjing Univ. Aeronautics Astronautics, China

<sup>\*\*</sup>Col. Electrical Eng. Contr. Sci., Nanjing TECH Univ., China

were achieved, which can also alleviate the reverse-recovery problem for all of the diodes and reduce the voltage stress. However, according to an analysis of reliability in [16], the active devices have negative effects on the reliability of the system. In addition, the active soft-switching techniques implemented by adding auxiliary switches or changing the topology have problems in terms of difficult modulation, high voltage or current stress, large number of resonant components and large losses. Therefore, a snubber circuit is the only way to achieve soft switching without active devices. In snubber circuits, the power circuits of main switches are connected in parallel with the capacitive branch or in series with the inductor elements to avoid withstanding high voltage and high current. Thus, passive soft-switching technology based on the snubber circuit has attracted more attention due to its characteristics of no additional auxiliary switches or corresponding control circuits, less additional loss and high reliability. The authors of [17] proposed a soft-switching three-level inverter that reduced the switching losses with very few passive devices. In [18], lossless passive soft-switching properties and synthesis procedures that are appropriate for all PWM converters are introduced. In addition, the full-bridge and half-bridge soft-switching inverter topologies were also deduced to verify the correctness of principle along with its characteristics of the simple structure and low voltage stress.

Another way to increase system efficiency is by using a simple and efficient topology. The dual buck inverter<sup>[19]</sup> exploited in recent years is different from full-bridge or half-bridge inverters, and the topology is shown in Fig. 1. The inverter has no shoot-through problem or reverse recovery problem of the body diode, which reduces the reverse recovery loss and increases the system efficiency. In order to improve voltage utilization and reduce the voltage stress based on dual buck inverters, the multi-level dual buck inverters including the diode clamped type and flying capacitor type were studied in [19]-[21], and the dual buck full-bridge-type inverters were proposed in [22], [23]. However, conventional dual buck inverters<sup>[19]-[23]</sup> still have an inherent weakness in terms of requiring two or more inductors, which increases the volume and cost of the system. On the basis of the dual buck topology, a single-inductor dual buck full-bridge inverter was proposed, which preserved the advantages of dual buck inverters<sup>[18]-[23]</sup>. The voltage reversal bridge structure is used to make the DC input side remove a large voltage divider to increase the DC voltage utilization. In addition, the inverter only uses a single inductor for filtering, which reduces the volume and weight of the system and improves the integration.

According to the above-mentioned ideas, this paper proposes a new topology called the passive lossless soft-switching single inductor dual buck full-bridge inverter (PLSSIDBFBI). This topology retains the advantages of no

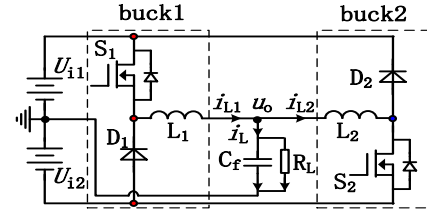

Fig. 1. Dual buck half-bridge inverter.

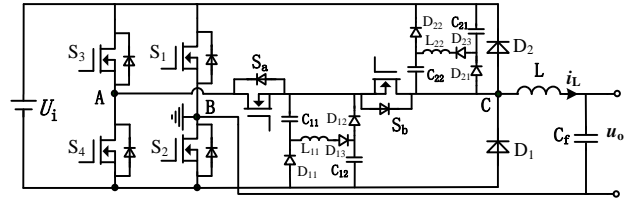

Fig. 2. Passive lossless soft-switching single inductor dual buck full-bridge inverter.

shoot-through problem, no body diode reverse recovery problem, high input voltage utilization rate and using one filter inductor. The high-frequency main switches realize lossless soft switching by adding snubber circuits, and the snubber circuits have no resistors or switches, which makes the topology simple and system reliability high.

## II. OPERATING PRINCIPLE

The topology of the PLSSIDBFBI is shown in Fig. 2. The PLSSIDBFBI has two stages, the preceding stage introduces a full-bridge circuit to achieve commutation of the input voltage, and the second stage performs high-frequency chopping modulation through switches  $S_a$  and  $S_b$ . In addition, one inductor, two capacitors and three diodes compose a passive lossless snubber circuit. The proposed topology works in the half-cycle mode with a parallel structure constituted by two Buck circuits, where Buck I consists of  $S_2$ ,  $S_3$ ,  $S_a$ ,  $D_1$ ,  $L$  and  $C_f$ , and Buck II consists of  $S_1$ ,  $S_4$ ,  $S_b$ ,  $D_2$ ,  $L$  and  $C_f$ . The two Buck circuits operate alternately in one power-frequency cycle, where  $D_1$  and  $D_2$  provide the freewheeling circuit for the inductor current when  $i_L > 0$  and  $i_L < 0$ .

Since the switching frequency, voltage and current applied on switches  $S_a$  and  $S_b$  are high, the two switches produce considerable switching loss. Therefore, adding passive devices on the power circuits is a dominant solution to decrease the peak voltage and current of the switches and to reduce the switching loss.

Operating waveforms of the PLSSIDBFBI and snubber circuit are shown in Fig. 3 and Fig. 4. The corresponding operating modes are shown in Fig. 5.

### A. $t_0-t_1$

During this stage,  $i_L > 0$ ,  $u_o > 0$ . Buck I circuit works in the PWM mode while Buck II is suspended. Two modes are

included in the operating process:

1) *Working Mode 1*: As shown in Fig. 5(a),  $S_1$  and  $S_4$  are turned off, while  $S_2$ ,  $S_3$ ,  $S_a$  and  $S_b$  are turned on. The output current  $i_L$  rises linearly.

During this mode, the voltage and current waveforms of  $S_a$  ( $i_{S_a}$ ,  $u_{S_a}$ ) are shown in Fig. 4, in the duration from  $t_0$  to  $t_2$ . As the figure shows,  $u_{S_a}$  declines rapidly to zero.  $i_{S_a}$  keeps rising to charge both the load and the series branch ( $C_{12}$ - $L_{11}$ - $D_{13}$ - $C_{11}$ ) in the snubber circuit. The  $L_{11}$  performances resonant behavior with  $C_{11}$  and  $C_{12}$ , and the resonance frequency can be expressed as:

$$\omega = \frac{1}{\sqrt{L_{11}[C_{11}C_{12}/(C_{11} + C_{12})]}} \quad (1)$$

The currents  $i_{S_a}$  and  $i_{L_{11}}$  (current through  $L_{11}$ ) change in accordance with a second order oscillation. In addition, after half of a resonant cycle,  $i_{L_{11}}$  decreases from positive to negative through the zero-crossing point, and  $D_{13}$  becomes reverse-biased at  $t_0$ , which is the end of the resonant operation. The current through  $L_{11}$  during the resonance can be obtained from:

$$i_{L_{11}}(t) = \frac{U_i}{Z_0} \sin \omega(t - t_0) \quad (2)$$

where,  $Z_0$  is the equivalent impedance of  $L_{11}$ ,  $C_{11}$  and  $C_{12}$ ;  $U_i$  is the input voltage; and there is:

$$Z_0 = \sqrt{L_{11}[C_{11}C_{12}/(C_{11} + C_{12})]} \quad (3)$$

The sum of the voltages across  $C_{11}$  and  $C_{12}$  can be expressed as:

$$u_C(t) = U_i - U_i \cos \omega(t - t_0) \quad (4)$$

$$u_{C_{11}}(t) = \frac{C_{12}}{C_{11} + C_{12}} u_C(t) \quad (5)$$

$$u_{C_{12}}(t) = \frac{C_{11}}{C_{11} + C_{12}} u_C(t) \quad (6)$$

When  $C_{11} = C_{12}$ , the voltages across  $C_{11}$  and  $C_{12}$  are both  $U_i$  at  $t_1$ .

2) *Working Mode 2*: As shown in Fig. 5(b),  $S_a$  is turned off,  $S_1$  and  $S_4$  remain in the turn-off state, while  $S_2$ ,  $S_3$  and  $S_b$  remain in the turn-on state.  $D_1$  is the freewheeling diode that is forward biased to maintain the output current. The output current  $i_L$  decreases linearly.

During this mode, the voltage and current waveforms of  $S_a$  ( $i_{S_a}$ ,  $u_{S_a}$ ) are shown in Fig. 4, in the duration from  $t_2$  to  $t_4$ . At  $t = t_2$ ,  $i_{S_a}$  decreases. The two parallel branches composed of ( $C_{11}$ ,  $D_{11}$ ) and ( $C_{12}$ ,  $D_{12}$ ) can be regarded as a parallel connection with the switch  $S_1$  through the input voltage  $U_i$ . Since the voltages across the capacitors  $C_{11}$  and  $C_{12}$  cannot appear to mutate, the Zero-Voltage-Switching (ZVS) turn-off of  $S_a$  can be achieved.

When  $S_a$  is turned off softly,  $C_{11}$  and  $C_{12}$  begin to discharge.

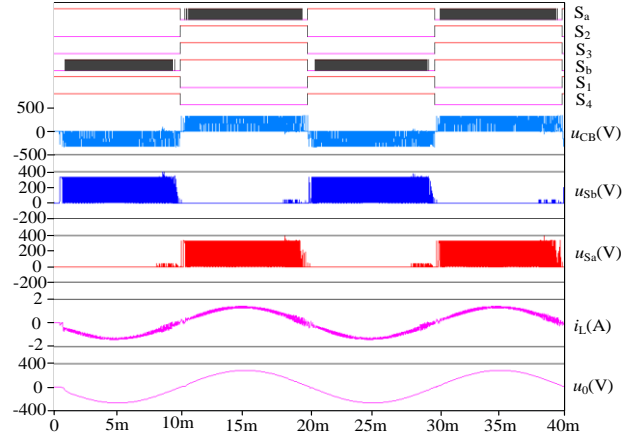

Fig. 3. Key waveforms of the passive lossless soft-switching dual buck full-bridge inverter.

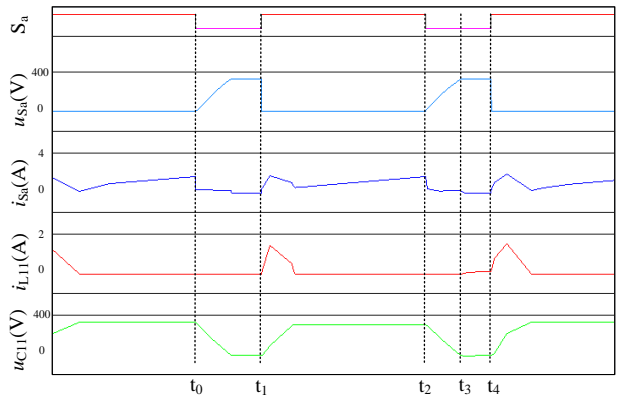

Fig. 4. Key waveforms of a snubber circuit.

$u_{S_a}$  rises from zero, and the voltage across  $S_a$  can be expressed as:

$$u_{S_a}(t) = U_i - U_{C_{11}}(t) \quad (7)$$

The discharge process continues until  $t_3$ , when  $u_{C_{11}}$  and  $u_{C_{12}}$  decline to zero and  $u_{S_1}$  rises to  $U_i$ .

#### B. $t_1$ - $t_2$

During this stage,  $i_L < 0$ ,  $u_o < 0$ . Buck II works in the PWM mode while Buck I is suspended. Two modes are included in the operating process:

3) *Working Mode 3*: As shown in Fig. 5(c),  $S_1$ ,  $S_4$ ,  $S_a$  and  $S_b$  are turned on, while  $S_2$  is turned off. The output current  $i_L$  rises linearly.

During this mode, the voltage and current waveforms of  $S_b$  ( $i_{S_b}$ ,  $u_{S_b}$ ) are similar to those of  $S_a$ , as shown in Fig. 4, from  $t_0$  to  $t_2$ .  $i_{S_b}$  charges both the load and the series branch ( $C_{21}$ - $D_{23}$ - $L_{22}$ - $C_{22}$ ) in the snubber circuit.

4) *Working Mode 4*: As shown in Fig. 5(d),  $S_b$  is turned off, and  $S_2$  and  $S_3$  remain in the turn-off state, while  $S_1$ ,  $S_4$  and  $S_a$  remain in the turn-on state.  $D_2$  is the freewheeling diode that is forward-biased to maintain the output current. The output current  $i_L$  decreases linearly.

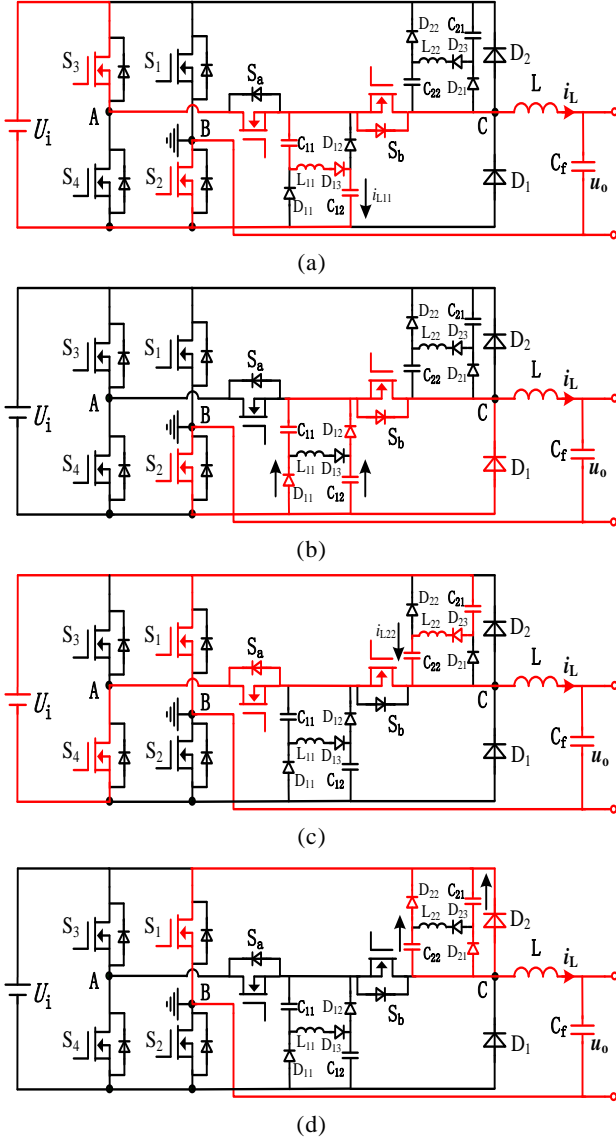

Fig. 5. Operating modes of the passive lossless soft-switching dual buck full bridge inverter. (a) Mode 1. (b) Mode 2. (c) Mode 3. (d) Mode 4.

During this mode, the voltage and current waveforms of S<sub>b</sub> (i<sub>Sb</sub>, u<sub>Sb</sub>) are similar to those of S<sub>a</sub>, as shown in Fig. 4, from t<sub>2</sub> to t<sub>4</sub>. The two parallel branches composed of (C<sub>21</sub>, D<sub>21</sub>) and (C<sub>22</sub>, D<sub>22</sub>) can be regarded as being in parallel connection with the switch S<sub>b</sub> through the input voltage U<sub>i</sub>. The energy stored in the capacitors C<sub>21</sub> and C<sub>22</sub> is transferred to the load. In addition, the Zero-Voltage-Switching (ZVS) turn-off of S<sub>b</sub> can be achieved.

### III. PARAMETER DESIGN OF THE SNUBBER CIRCUIT AND LOSS ANALYSIS

#### A. Parameter Design of the Snubber Circuit

In case of the specified parameters of the main circuit, the capacitances and inductances in the snubber circuit have a

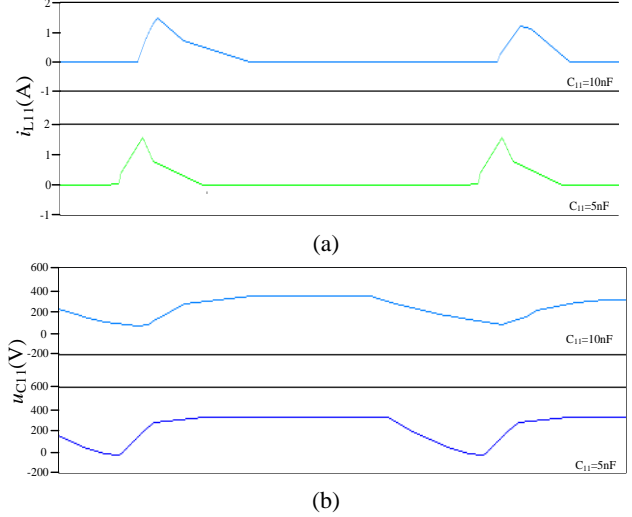

Fig. 6. Simulation waveforms of the snubber circuit with different capacitances. (a) Oscillating current i<sub>L11</sub>. (b) Capacitor voltage u<sub>C11</sub>.

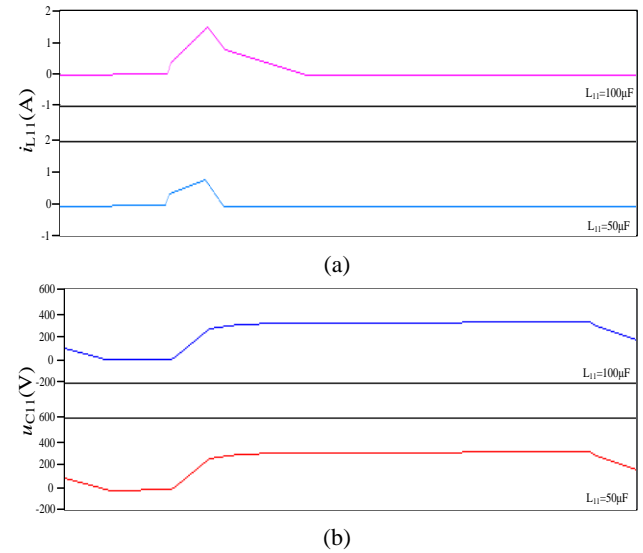

Fig. 7. Simulation waveforms of the snubber circuit with different inductances. (a) Oscillating current i<sub>L11</sub>. (b) Capacitor voltage u<sub>C11</sub>.

great effect on the operation performance of the topology. Taking S<sub>a</sub> as an example, simulation waveforms of the snubber circuit with different capacitances and inductances are shown in Fig. 6 and Fig. 7.

As shown in Fig. 6(b), the discharging rate of C<sub>11</sub> decreases with an increase of C<sub>11</sub>. In other words, the decreasing rate of u<sub>C11</sub> and the increasing rate of u<sub>Sa</sub> both slow down. Therefore, the switch loss of S<sub>a</sub> is reduced. However, an increase of C<sub>11</sub> increases the current through S<sub>a</sub> and oscillating period, which can be seen from Fig. 6(a).

As shown in Fig. 7, the current through S<sub>a</sub> decreases with an increase of L<sub>11</sub>. However, the oscillating period increases.

Consequently, the values of C<sub>11</sub>, C<sub>12</sub> and L<sub>11</sub> are direct influence factors for the operation of circuit. In addition, the

values are restricted by the current withstand capability and switch-on time of the power switch.

The peak oscillating current of the snubber circuit during the conduction period of  $S_a$  can be expressed as:

$$i_{L11\max} = \frac{U_i}{Z_0} = U_i \sqrt{C_{11}/2L_{11}} \quad (8)$$

When  $S_a$  is turned on, the current through  $S_a$  can be expressed as:

$$i_{S_a} = i_{L_{11}} + i_L \quad (9)$$

where,  $i_L$  is the current through the inductor  $L$ , and  $i_{L11}$  is the oscillating current through the inductor  $L_{11}$ .

Since the peak oscillating current has the feature of  $I_{S_{a\max}} > I_{L11\max}$ , the value of  $L_{11}$  can be expressed as:

$$L_{11} > \frac{U_i C_{11}}{2i_{S_a\max}^2} \quad (10)$$

The values of  $C_{11}$ ,  $C_{12}$  and  $L_{11}$  are also restricted by the switch-on time of the power switch. In order to ensure that  $C_{11}$  and  $C_{12}$  are charged to  $U_i$ , the half resonant process should be finished in the switch-on time of  $S_a$ , that is:

$$\frac{\pi}{\omega} \leq T_{on\min} \quad (11)$$

where,  $\omega$  is the resonant angular frequency, and  $T_{on\min}$  is minimum switch-on time of the power switch.

When  $C_{11}=C_{12}$ :

$$T_{on\min} \geq \pi \sqrt{L_{11}(C_{11}/2)} \quad (12)$$

When the duty ratio of  $S_a$  is tiny, the half resonant process cannot be realized. However, the inductor current and the turn-off loss of the power switch are small at this moment. Setting the switching frequency to  $f_s=60$  kHz and  $T_{on\min}=0.6\mu s$  in the experiment, there is  $T_s=6\mu s$ .

With the introduction of a snubber circuit, the turn-off loss of the power switch is reduced. However, the conduction loss increases for the oscillating current. Therefore, the influence of the system loss should be taken into consideration to design the parameters of  $C_{11}$ ,  $C_{12}$  and  $L_{11}$ .

In one switching cycle, the turn-off loss of the power switch  $S_a$  can be obtained from:

$$P_{\text{Soff}} = \frac{1}{T} \sum_{i=1}^{N_s} \left[ \frac{1}{2} U_i(i) i_{S_a}(i) \frac{t_{fr}^2(i)}{t_{fr}(i) + t_f(i)} + \frac{5}{6} U_{FR}(i) i_{S_a}(i) \frac{t_{fr}^2(i)}{t_{fr}(i) + t_f(i)} \right] \quad (13)$$

where,  $N_s$  is the switching time of the power switches per cycle,  $i_{S_a}(i)$  is the current through  $S_a$  before the  $i^{\text{th}}$  turn-off of  $S_a$ ,  $U_i(i)$  is the voltage across  $S_a$  before the  $i^{\text{th}}$  turn-off of  $S_a$ ,  $t_f(i)$  is the fall time of  $S_a$  before the  $i^{\text{th}}$  turn-off of  $S_a$ , and  $t_{fr}(i)$  and  $U_{FR}(i)$  are the rise time and forward peak voltage of the diode when it becomes forward-biased for the  $i^{\text{th}}$  time.

The conduction loss of the power switch  $S_a$  can be expressed as:

$$P_{\text{Son-state}} = \frac{1}{T} \sum_{i=0}^{N_s} \int_0^{D(i)T_s(i)} i_{on-state}^2(i) R_{ds(on)} dt \quad (14)$$

where,  $T_s(i)$  is the switching period,  $D(i)$  is the duty ratio,  $i_{on-state}(i)$  is the current through  $S_a$  when  $S_a$  is turned on for the  $i^{\text{th}}$  time, and  $R_{ds(on)}(i)$  is the on-resistance of  $S_a$ .

According to the parameters of the power switch and diode, the increment in the conduction loss of the power switch  $S_a$  after adding the snubber circuit can be calculated as:

$$\Delta P_{\text{Son-state}} = \frac{1}{T} \sum_{i=0}^{N_s} \int_0^{D(i)T_s(i)} [i_{L_{11}}^2(i) + 2i_{L_{11}}(i)i_L(i)] R_{ds(on)} dt \quad (15)$$

The increment in the turn-off loss of the power switch  $S_a$  can be obtained as:

$$\Delta P_{\text{Soff}} = \frac{1}{T} \sum_{i=1}^{N_s} \left[ -\frac{1}{4} U_i i_{L_{11}}(i) \frac{t_{fr}^2(i)}{t_{fr}(i) + t_f(i)} \right] \quad (16)$$

To make the added snubber circuit helpful for decreasing the system loss, the increment of the conduction loss must be less than the increment of the turn-off loss. Accordingly, there is:

$$\int_0^{D(i)T_s(i)} \left[ \frac{i_{L_{11}}^2(i)}{i_L(i)} + 2i_{L_{11}}(i) \right] R_{ds(on)} dt < \frac{1}{4} U_i \frac{t_{fr}^2(i)}{t_{fr}(i) + t_f(i)} \quad (17)$$

From (8) and (17), equation (18) can be derived as:

$$\frac{U_i C_{11}}{2L_{11}} + \sqrt{2C_{11}/L_{11}} < \frac{1}{2T_s R_{ds(on)}} \frac{t_{fr}^2(i)}{t_{fr}(i) + t_f(i)} \quad (18)$$

## B. Loss Analysis

In general, the total losses of transformerless inverters are composed of the switching and conduction loss of the power switches and power diodes along with the hysteresis loss ( $P_{Fe}$ ) and copper loss ( $P_{cu}$ ) of the inductors. In the proposed PLLSSIDBFBI, the total losses mainly consist of the followings: the four switches in the full-bridge circuit switch only once per power-frequency cycle, the switching loss can be ignored and only the conduction loss needs to be considered. According to the parameter design of the snubber circuit in chapter III, the two high-frequency switches cannot be turned off softly when  $D_{T0} < 0.1$ . However, only the turn-on loss and conduction loss need to be considered since both the inductor current and the switching loss of the switches are small. To power the diodes, only the turn-off loss and conduction loss need to be considered because in one buck circuit, the turn-on of the high-frequency switches means the turn-off of the corresponding power diodes. Conversely, the turn-off of the power diodes means the turn-off of the high-frequency switches. According to the theoretical loss analysis of inverters in [28], the conduction loss of the switches is shown in equation (14), and the turn-on loss can be expressed as:

$$P_{\text{Son}} = \frac{1}{T} \sum_{i=0}^{N_s} \left[ \frac{1}{2} U_i i_{S_a}(i) t_r(i) + \frac{2}{3} U_i I_{RM}(i) t_{rr}(i) \right] \quad (19)$$

Further, the turn-off loss of the corresponding diodes can be obtained as:

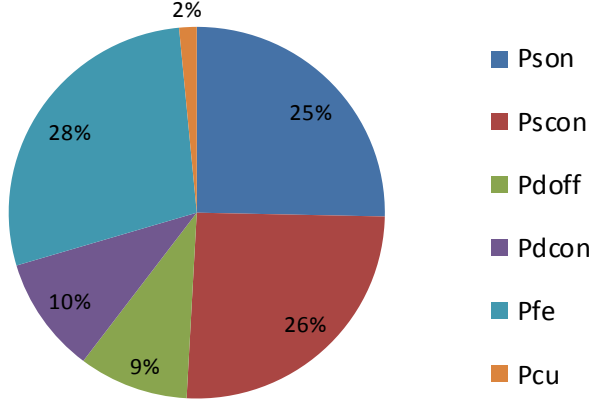

Fig. 8. Losses compositions at a full load.

$$P_{\text{Doff}} = \frac{1}{T} \sum_{i=0}^{N_s} \left\{ U_F(i) [i_{Sa}(i) + I_{RM}(i)] t_r(i) + \frac{1}{4} U_F(i) i_{Sa}(i) t_{rr}(i) + \frac{1}{3} U_i I_{RM}(i) t_{rr}(i) \right\} \quad (20)$$

where,  $I_{RM}(i)$  is the peak reverse recovery current of the diode,  $t_r(i)$  is the rise time of the switch turned on for the  $i^{\text{th}}$  time, and  $t_{rr}(i)$  is the reverse recovery time of the diode turned off for the  $i^{\text{th}}$  time.

The conduction loss of the diodes can be expressed as:

$$P_{\text{Dcon}} = \frac{1}{T} \sum_{i=0}^{N_s} \int_0^{(1-D(i))T_s(i)} i_{\text{Don}}(i) U_F(i) dt \quad (21)$$

where,  $i_{\text{Don}}(i)$  is the current through the diode during the  $i^{\text{th}}$  switching process, and  $U_F(i)$  is the forward voltage drop of the diode.

The hysteresis loss of the inductor can be obtained from the improved Steinmetts equation:

$$P_{\text{Fe}} = f(C_m f_{eq}^{\alpha-1} \Delta B^\beta) \quad (22)$$

where  $f$  is the switching frequency,  $\Delta B$  is the amplitude of the magnetic flux density, and  $\alpha$  and  $\beta$  are experienced parameters provided by the data sheets of the magnetic core. In addition, there is:

$$f_{eq} = \frac{2f}{D(1-D)\pi^2} \quad (23)$$

The copper loss of the inductor is determined by the equivalent resistance  $R_L$  of the inductor as:

$$P_{cu} = I_L^2 R_L = I_L^2 \rho_{cu} \frac{Len}{Csa} \quad (24)$$

where,  $\rho_{cu}$  is the resistivity of the copper wires,  $Len$  is the length of the copper wires, and  $Csa$  is the sectional area of the copper wires.

By plugging the prototype parameters of the proposed buck inverter into the above equations, a pie chart of the losses compositions at a full load can be drawn as shown in Fig. 8.

#### IV. RELIABILITY ANALYSIS

In addition to efficiency, reliability is another important factor for evaluating a topology. The number of devices has the major influence on system reliability. When this number is reduced, the topology and control method are simplified, and the failure rate becomes smaller. Generally, when compared with active devices, passive devices have a higher reliability.

In order to quantitatively calculate the reliability of the topology, the MIL-HDBK-217 handbook is used for reliability prediction. Based on reliability engineering theory, the reliability  $R_p$  of a system can be calculated as:

$$R_p = \prod_{i=1}^n R_i \quad (25)$$

$$R_i = \exp(-\lambda_{pi} t) \quad (26)$$

where,  $R_i$  is the individual reliability of the involved components, and  $\lambda_{pi}$  is the actual failure rate of the device, which is given by:

$$\lambda_p = \lambda_b \prod_{i=1}^m \pi_i \quad (27)$$

where,  $\pi_i$  is the modifying factors of each device,  $m$  is the number of modifying factors, and  $\lambda_b$  is the basic failure rate of the electronic devices.

Usually, power electronics apparatus are constructed with transistors, diodes, capacitors and inductors. The modifying factors of these devices are listed in Table I.

As the table shows, the factor  $\pi_T$  is related to temperature, which can be calculated by equation (28). The term  $T_j$  is the junction temperature for the transistors and diodes, or the hotspot temperature for the inductors and capacitors. It can be estimated by equation (29), where  $\theta_{JA}$  is the junction-ambient thermal resistance,  $P$  is the loss dissipated by the device, and  $T_A$  is the ambient temperature.

The quality factor  $\pi_Q$  is a direct influence factor to the failure rate. Many devices are covered by specifications that have several quality levels.

The environment factor  $\pi_E$  varies with the operational environment, and it is assumed that when the environment is ground benign (GB),  $\pi_E=1$ .

The application factor  $\pi_A$  varies with the operational power of the device.

The inductance factor  $\pi_L$  varies with the inductor structure. It is assumed that in the case of a fixed inductor structure,  $\pi_L=1$ .

The capacitor factor  $\pi_C$  varies with the value of the capacitor, which is expressed with microfarads. This factor is expressed in equation (30) where  $C$  is the value of the capacitor.

The factor  $\pi_V$  varies with the ratio  $S$  between the operating voltage and rated voltage across the capacitor. It can be calculated by equation (31).

TABLE I  
MODIFYING FACTORS

Factors	Switch	Diode	Capacitor	Inductor
$\pi_T$	○	○	○	
$\pi_Q$	○	○	○	○
$\pi_E$	○	○	○	○
$\pi_A$	○			
$\pi_L$				○
$\pi_C$			○	
$\pi_V$			○	
$\pi_S$		○		

TABLE II  
FACTORS OF DEVICES

	Switch	Diode	Capacitor (1n/450p/0.44μ)	Inductor
$\lambda_b$	0.012	0.025	0.00012	0.0003
$\pi_T$	3.62	7.56	13.36	
$\pi_Q$	8	8	10	1
$\pi_E$	1	1	1	1
$\pi_A$	8			
$\pi_C$				1
$\pi_{CV}$			0.20/0.16/0.83	
$\pi_V$			8.59	
$\pi_S$		0.29		
$\lambda_p$	2.78	0.44	0.028/0.022/0.11	0.0003

TABLE III  
COMPARISON OF SEVERAL TRANSFORMERLESS PV INVERTER TOPOLOGIES

Items	Hard-switching transformerless inverter					Soft-switching transformerless inverter			
	H5	H6	HERIC	DBFBFLI [25]	SIDBFBI [24]	SLF-H6-I [14]	ZVT-HERIC [15]	PLSSIDBFBI	
Input voltage capacitors	1	1	1	1	1	2	2	1	
High-frequency switches	3	2	4	2	2	4	6	2	
Low-frequency switches	2	4	2	2	4	4	4	4	
Independent diodes	0	2	0	2	2	2	2	8	
Filter inductor	2	2	2	2	1	2	2	1	
Half-cycle working body diodes	1	0	1	0	0	0	0	0	

The factor  $\pi_S$  varies with the ratio  $V_S$  between the reverse voltage and rated reverse voltage across the diode. In can be calculated by equation (32).

$$\pi_T = \exp \left[ -A \left( \frac{1}{T_j + 273} - \frac{1}{298} \right) \right] \quad (28)$$

$$T_j = T_A + \theta_{JA} P \quad (29)$$

$$\pi_C = C^{0.23} \quad (30)$$

$$\pi_V = \left( \frac{S}{0.6} \right)^5 + 1 \quad (31)$$

$$\pi_S = V_S^{2.43} \quad (32)$$

Under the same rated power, grid voltage and voltage stress, a comparison of several typical hard-switching transformerless inverter topologies and soft-switching transformerless inverter topologies in terms of reliability is conducted. By assuming that the power switches are MOSFETs IRFP460, the power diodes are DSEI60-06A, the input DC bus voltage  $U_i$  is equal to 360V, and the ambient temperature  $T_A$  is 55°C, the factors of the employed devices are listed in Table II, and a comparison of several transformerless PV inverter topologies is shown in Table III.

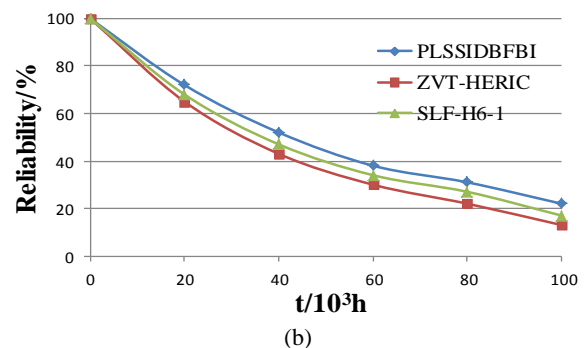
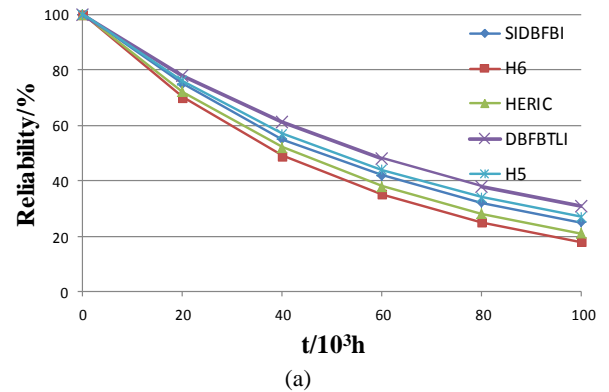

Fig. 9. Comparison of reliability. (a) Hard switching. (b) Soft switching.



Comparison results in terms of reliability are shown in Fig. 9. When compared with other hard-switching transformerless inverter topologies, the SIDBFBI topology has only two high-frequency switches, which makes its reliability higher than that of H<sub>5</sub>-type topologies, H<sub>6</sub>-type topology and the HERIC-type topology, but slightly lower than that of the DBFBFLI topology. However, only one inductor is adopted in the SIDBFBI topology, which economizes the cost. In addition, the saving part of the AC filter can also decrease the volume and weight of the system. The PLSIDBFBI topology proposed in this paper is constructed based on the SIDBFBI. As shown in Fig. 9(b), when compared with other soft-switching transformerless inverter topologies, the snubber circuit of the PLSIDBFBI has no additional active devices, which simplifies the control strategy, facilitates the testing and improves the system reliability.

## V. EXPERIMENTS

An experimental prototype has been built in the laboratory with the listed parameters to further verify the practical operating performance of the proposed inverter:  $U_i=360\text{VDC}$ ,  $L=600\mu\text{H}$ ,  $C_f=1\mu\text{f}$ , and  $u_o=220\text{VAC}/50\text{Hz}$ . The controllable switches ( $S_1\sim S_4$ ,  $S_a$ ,  $S_b$ ) use power MOSFETs (IPW65R037C6). The power diodes  $D_1\sim D_2$  use DSEI60-06A.

From equations (10) and (12), the capacitances and inductances of the snubber circuit can be obtained as:  $C_{11}=C_{12}=C_{21}=C_{22}<3.8\text{nF}$  and  $L_{11}=L_{22}>10\mu\text{H}$ . For experimental testing, the values are set as:  $C_{11}=C_{12}=C_{21}=C_{22}=2\text{nF}$  and  $L_{11}=L_{22}=50\mu\text{H}$ .

From equations (15)-(18) the added snubber circuit increases the conduction loss. However, when compared with the turn-off loss, the increased loss has little influence on the system. Taking the practical conditions into account, the parameters of the snubber circuit are taken as  $I_{L11\text{max}}<I_{L\text{max}}$ .

Experimental waveforms of the proposed PLSIDBFBI are shown in Fig. 10. Fig. 10(a) presents part of the driving voltage waveforms, which verify the validity of the adopted high and low frequency modulation strategy. Output waveforms are illustrated in Fig. 10(b) and Fig. 10(c). Fig. 10(b) presents output waveforms at a light load (200W), which shows that the relations of the waveforms and phase are in accordance with the theoretical analysis. The output waveforms at a full load (1008W) shown in Fig. 10(c) demonstrate that the output waveforms have better performance than those at a light load. Fig. 11 is a comparison of waveforms of the topology with and without a snubber circuit. With the introduction of a snubber circuit, the voltage approaches zero when the power switch is gated off. Therefore, the turn-off loss of the power switch is decreased. When the power switch is gated on, the capacitor and inductor in the snubber circuit resonate and the energy is stored in the snubber circuit. In addition, when the power switch is gated off, the energy is delivered back to load.

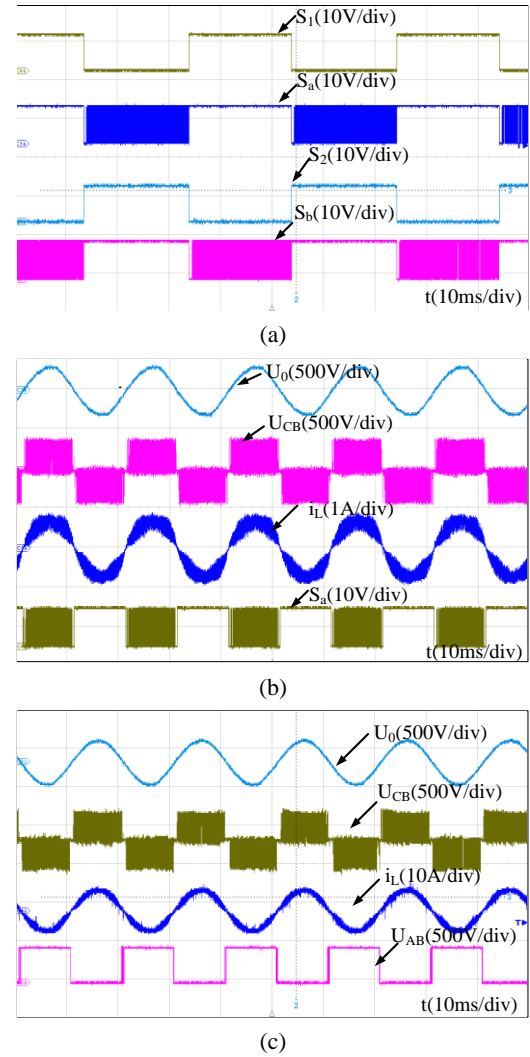

Fig. 10. Experiment waveforms of the passive lossless soft-switching dual buck full bridge inverter.

As analyzed above, the zero-voltage turn-off of high-frequency switches is achieved in the proposed PLSSIDBFBI. In addition, the operating efficiency is improved by delivering stored energy back to the input through snubber circuits. A comparison of the efficiency between several typical transformerless inverters and the PLSSIDBFBI is shown in Fig. 12. As shown in Fig. 12(a), when compared with the SIDBFBI, the snubber circuit in the PLSSIDBFBI reduces the switching loss and increases the system efficiency. The hard-switching transformerless inverters H<sub>6</sub> and HERIC have high efficiencies that are slightly below that of the PLSSIDBFBI. However, the previous two inverters possess only a 20 kHz frequency and require a much larger inductor. In addition, as shown in Fig. 12(a), the proposed PLSSIDBFBI produces a higher efficiency at the same frequency when compared with soft-switching SLF-H<sub>6</sub>-I and ZVT-HERIC. Based on the factors analyzed above, the proposed inverter can achieve both a high efficiency and a decrease in system volume.



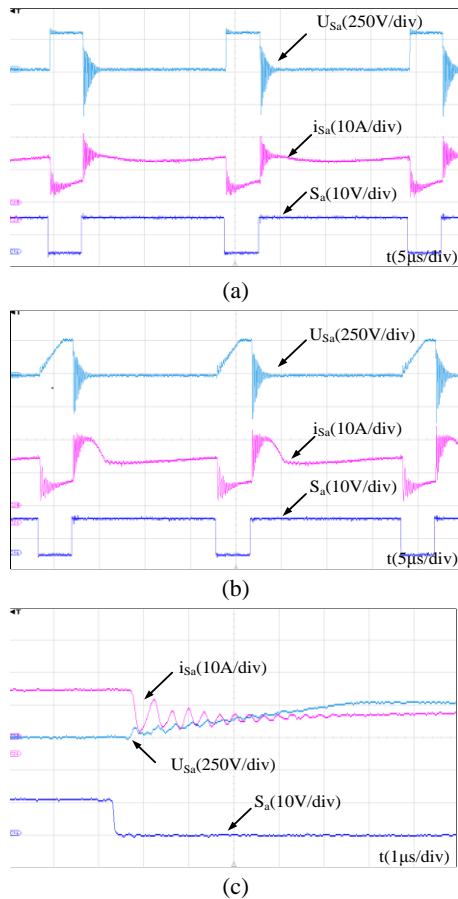

Fig. 11. Comparison of experimental waveforms of switches. (a) Experimental waveforms of a switch without a snubber circuit. (b) Experimental waveforms of a switch with a snubber circuit. (c) Experimental waveforms of a switch with a snubber circuit.

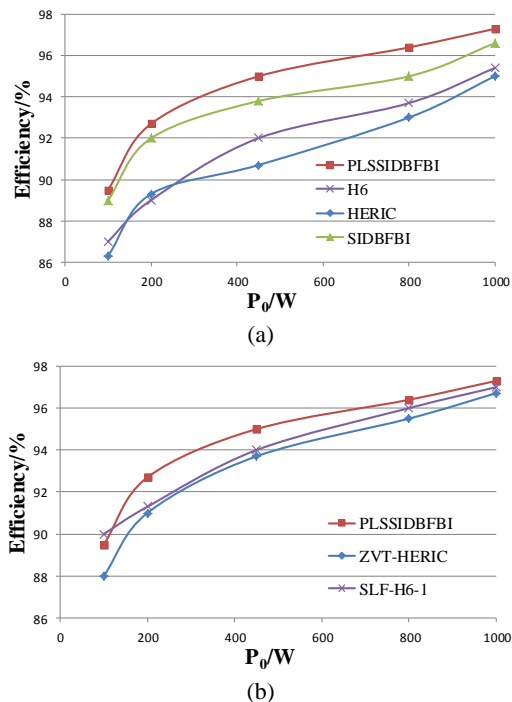

Fig. 12. Comparison of efficiency.

## VI. CONCLUSIONS

The novel soft-switching inverter proposed in this paper provides an effective way to increase system efficiency and reliability. According to the above analysis, this inverter has the following features:

- 1) The advantages of dual buck inverters, such as high conversion efficiency and high reliability, are retained by the proposed topology. The problems of shoot-through and the reverse recovery of the body diode are removed. In addition, the voltage commutation bridge is adopted to increase the utilization rate of the input voltage and to reduce the voltage stress.
- 2) When compared with other transformerless inverter topologies, the proposed inverter has only one filter inductor. Therefore, the volume and weight of the system are further decreased, and the integration is more improved.
- 3) The added snubber circuit realizes lossless soft switching by its own resonance, which simplifies the control strategy, facilitates testing and improves system reliability.

## ACKNOWLEDGMENT

This work was supported in part by the Shanghai Aerospace Science and Technology Innovation Fund under Grant SAST2015037, the Natural Science Foundation of Jiangsu Province under Grant BK20140944 and the National Natural Science Foundation of China under Grant 51607086.

## REFERENCES

- [1] H. Xiao, K. Lan, and L. Zhang, "A quasi-unipolar SPWM full-bridge transformerless PV grid-connected inverter with constant common-mode voltage," *IEEE Trans. Power Electron.*, Vol. 30, No. 6, pp. 3122-3132, Jun. 2015.
- [2] L. Zhang, K. Sun, Y. Xing, and M. Xing, "H6 transformerless full-bridge PV grid-tied inverters," *IEEE Trans. Power Electron.*, Vol. 29, No. 3, pp. 1229-1238, Mar. 2014.
- [3] W. Li, Y. Gu, H. Luo, W. Cui, X. He, and C. Xia, "Topology review and derivation methodology of single-phase transformerless photovoltaic inverters for leakage current suppression," *IEEE Trans. Ind. Electron.*, Vol. 62, No. 7, pp. 4537-4551, July. 2015.
- [4] S. V. Ara'ujo, P. Zacharias, and R. Mallwitz, "Highly efficient single-phase transformerless inverters for grid-connected photovoltaic systems," *IEEE Trans. Ind. Electron.*, Vol. 57, No. 9, pp. 3118-3128, Sep. 2010.
- [5] H. Kim, Y. Chung, K. Lee, Y. Jon, and K. Kim, "Performance analysis of soft-switching inverter for the photovoltaic power system," in *Proc. Int. Conf. Power Electron.*, Vol. 1, pp. 436-439, Oct. 2007.
- [6] F. Liu, J. Yan, and X. Ruan, "Zero-voltage and zero-current-switching PWM combined three-level DC/DC converter," *IEEE Trans. Ind. Electron.*, Vol. 57, No. 5, pp. 1644-1654, May. 2010.
- [7] D. M. Divan, "The resonant DC link converter-a new concept in static power conversion," *IEEE Trans. Ind.*

- Appl.*, Vol. 25, No. 2, pp. 317-325, Mar/Apr. 1989
- [8] Z. Y. Pan and F. L. Luo, "Novel soft-switching inverter for brushless DC motor variable speed drive system," *IEEE Trans. Power Electron.*, Vol. 19, No. 2, pp. 280-288, Mar. 2004
- [9] J. S. Lai, J. Zhang, H. Yu, and H. Kouns, "Source and load adaptive design for a high-power soft-switching inverter," *IEEE Trans. Power Electron.*, Vol. 21, No. 6, pp. 1667-1675, Nov. 2006.
- [10] Y. P. Li, F. C. Lee, and D. Boroyevich, "A simplified three-phase zero-current-transition inverter with three auxiliary switches," *IEEE Trans. Power Electron.*, Vol. 18, No. 3, pp. 802-813, May 2003.
- [11] B. Chen, "Design and optimization of 99% CEC efficiency soft switching photovoltaic inverter," in *Proc. IEEE Appl. Power Electron. Conf.*, Vol. 1, pp. 946-951, Mar. 2013.
- [12] H. F. Xiao, X. P. Liu, and K. Lan, "Zero-voltage-transition full-bridge topologies for transformerless photovoltaic grid-connected inverter," *IEEE Trans. Ind. Electron.*, Vol. 61, No. 10, pp. 5393-5401, Oct. 2014
- [13] H. F. Xiao, K. Lan, B. Zhou, L. Zhang, and Z. Wu, "A family of zero-current-transition transformerless photovoltaic grid-connected inverter," *IEEE Trans. Power Electron.*, Vol. 30, No. 6, pp. 3156-3165, Jun. 2015.
- [14] H. F. Xiao, L. Zhang, and Y. Li, "An improved zero-current-switching single-phase transformerless PV H6 inverter with switching loss-free," *IEEE Trans. Ind. Electron.*, Vol. 64, No. 10, pp. 7896-7905, Oct. 2017.
- [15] H. F. Xiao, L. Zhang and Y. Li, "A zero-voltage-transition HERIC-type transformerless photovoltaic grid-connected inverter," *IEEE Trans. Ind. Electron.*, Vol. 64, No. 2, pp. 1222-1232, Feb. 2017.
- [16] F. Chan and H. Calleja, "Reliability estimation of three single-phase topologies in grid-connected PV systems," *IEEE Trans. Ind. Electron.*, Vol. 58, No. 7, pp. 2683-2689, Jul. 2011.
- [17] M. W. Gekeler, "Soft switching three level inverter with passive snubber circuit (S3L inverter)," *Proc. Eur. Conf. Power Electron. Appl.*, pp. 1-10, 2011.
- [18] K. M. Smith and K. M. Smedley, "Lossless passive soft-switching methods for inverters and amplifiers," *IEEE Trans. Power Electron.*, Vol. 15, No. 1, pp. 164-173, Jan. 2000.
- [19] J. Liu, H. Wang, and Y. Yan, "A novel three level dual buck half bridge inverter," *IEEE Applied Power Electronics Conference*, pp. 483-487, 2008.
- [20] F. Hong, P. Yin, B. Ji, W. Yang, and C. Wang, "Decoupling control of input voltage balance for diode-clamped dual buck three-level inverter," *IEEE Applied Power Electronics Conference (APEC)*, pp. 482-488, 2013.
- [21] M. Liu, F. Hong, and C. Wang, "A novel flying-capacitor dual buck three-level inverter," *IEEE Applied Power Electronics Conference (APEC)*, pp. 502-506, 2013.
- [22] Z. Yao, L. Xiao, X. Wei, and H. Wang, "Dual-buck full-bridge inverter with SPWM control and single current sensor," *IEEE Conference on Industrial Electronics and Applications*, pp. 2154-2158, 2010.
- [23] F. Hong, J. Liu, B. Ji, Y. Zhou, J. Wang, and C. Wang, "Interleaved dual buck full-bridge three-level inverter," *IEEE Trans. Power Electron.*, Vol. 31, No. 2, pp. 964-974, Feb. 2016.
- [24] F. Hong, J. Liu, B. Ji, Y. Zhou, J. Wang, and C. Wang, "Single inductor dual buck full-bridge inverter," *IEEE Trans. Ind. Electron.*, Vol. 62, No. 8, pp. 4869-4877, Aug. 2015.
- [25] H. Feng, Y. Jun, Y. Yangguang, S. Renzhong, and W. Huizhen, "A novel dual buck full bridge three-level inverter," China Patent 200 610 096 848.4, Nov. 12, 2008.
- [26] W.-S. Yu, J.-S. Lai, and H. Qian, "High-efficiency inverter with H6-type configuration for photovoltaic non-isolated ac module applications," *IEEE Applied Power Electronics Conference and Exposition (APEC)*, pp. 1056-1061, 2010.
- [27] P. S. Gotekar, S. P. Muley, D. P. Kothari, and B. S. Umre, "Comparison of full bridge bipolar, H5, H6 and HERIC inverter for single phase photovoltaic systems – A review," *IEEE India Conference (INDICON)*, pp. 1-6, 2015.
- [28] H. Feng, S. Renzhong, W. Huizhen, and Y. Yangguang, "A new analysis and calculation of inverter power loss," *Proceedings of the CSEE*, Vol. 28, No. 15, pp. 72-78, 2008.



**Feng Hong** was born in Anhui, China, in 1979. He received his B.S., M.S. and Ph.D. degrees in Power Electronics and Power Transmission from the Nanjing University of Aeronautics and Astronautics (NUAA), Nanjing, China, in 2001, 2004 and 2008, respectively. In 2008, he joined the College of Electronic and Information Engineering, NUAA, where he is presently working an Associate Professor. His current research interests include renewable energy generation systems, high-frequency power conversion and multi-level power conversion.



include high-frequency power conversion.

**Yu Wu** was born in Jiangsu, China, in 1994. She received her B.S. degree in Information Engineering from the Nanjing University of Aeronautics and Astronautics (NUAA), Nanjing, China, in 2016, where she is presently working towards her M.S. degree in Electronics and Communication Engineering. Her current research interests



renewable energy generation systems and high-frequency power conversion.

**Zunjing Ye** was born in Jiangsu, China, in 1994. He received his B.S. degree in Electrical Engineering and Control Science from the Nanjing Tech University, Nanjing, China, in 2014, where he is presently working towards his M.S. degree in Electrical Engineering and Control Science. His current research interests include



**Baojian Ji** received his B.S. degree in Automation Engineering from Nanjing Normal University, Nanjing, China, in 2002; his M.S. degree in Electrical Engineering from the Nanjing University of Aeronautics and Astronautics (NUAA), Nanjing, China, in 2007; and his PH.D. degree from Southeast University, Nanjing, China, in 2012. In 2017, he became an Associate Professor at Nanjing Tech University, Nanjing, China, where he is presently working as the Head of the Department of Electrical Engineering. His current research interests include digital control techniques and the development of grid-tied inverters for renewable energy.



**Yufei Zhou** was born in Nanjing, China, in 1984. She received her B.S., M.S. and Ph.D. degrees from the Nanjing University of Aeronautics and Astronautics (NUAA), Nanjing, in 2006, 2009 and 2013, respectively. In 2013, she joined the College of Electric and Information Engineering, NUAA. Her current research interests include renewable energy generation, Z-source converters and integrated power electronics modules.