

Sound Improvement of Violin Playing Robot Applying Auditory Feedback

Wonse Jo*, Jargalbaatar Yura* and Donghan Kim[†]

Abstract – Violinists learn to make better sounds by hearing and evaluating their own playing through numerous practice. This study proposes a new method of auditory feedback, which mimics this violinists' step and verifies its efficiency using experiments. Making the desired sound quality of a violin is difficult without auditory feedback even though an expert violinist plays. An algorithm for controlling a robot arm of violin playing robot is determined based on correlations with bowing speed, bowing force, and sound point that determine the sound quality of a violin. The bowing speed is estimated by the control command of the robot arm, where the bowing force and the sound point are recognized by using a two-axis load cell and a photo interrupter, respectively. To improve the sound quality of a violin playing robot, the sound information is obtained by auditory feedback system applied Short Time Fourier Transform (STFT) to the sounds from a violin. This study suggests Gaussian-Harmonic-Quality (GHQ) uses sounds' clarity, accuracy, and harmonic structure in order to decide sound quality, objectively. Through the experiments, the auditory feedback system improved the performance quality by the robot accordingly, changing the bowing speed, bowing force, and sound point and determining the quality of robot sounds by GHQ sound quality evaluation system.

Keywords: Violin playing robot, Auditory feedback, Human-robot interaction, Sound quality rating system

1. Introduction

In recent years, there has been the rapid development of robotics industry and the diversification of robot functionality, the direction of robotics research has widened from industrial robots to personal household robots, and cleaning robots [1]. Technical advances spotlight research on human-robot interaction (HRI), in which a variety of entertainment robots that can convey emotional expression and human-friendly mutual information have emerged. In order to recognize a human's intention, these robots employ visual, auditory, and tactile sensors, including but not limited to visual, audio and tactile sensors. In particular, studies on recognizing the individual's behavior and voice, and the various sounds are being actively conducted [2]. However, studies on auditory feedback, one of the representative elements in HRI, are only limitedly conducted in the medical field [3]. For instance, HRI is being used to help self-treat people who habitually stutter, allowing them to recognize when their voice deviates from established norms and adjust it to sound more natural. If this principle is applied to the HRI system, robots can play an instrument by hearing and evaluating the generated sound and then correcting the sound quality. Furthermore, robots can play

a concerto in accordance with the sound quality played by humans, and the same set of principles can be applied to evaluate the quality of a human orchestra's performance. The proposed auditory feedback system is one of a time delayed feedback system, which analyzes and calibrates the sound generated by robots to obtain the intended sound. Although extensive researches have been carried out on robots playing a musical instrument, no single study exists which adequately covers auditory feedback. The 'Waseda Saxophonist Robot' [4] and 'Flutist Robot' [5] were developed at Waseda University. These robots play instruments by controlling the artificial air flow using an air pump. It has a significant meaning because they mimic the function of lung which is humans' organ. However, a limitation is that it only copied a technical mechanism which is similar as humans' playing. As another kinds of robots playing a musical instrument, a violin playing robot was developed at Toyota based on the advanced control technology, and performed an actual demonstration [6]. This robot reveals significant values of excellent hardware design and control skills, and the robot accurately obeys preprogrammed commands. A violin playing robot that uses a control instruction with humans' sensibility by Kansei was researched in order to have the robot generate natural sounds at Ryukoku University [7, 13, 14]. However, the robot has a simple HRI which follows only arranged commands because it doesn't feedback to a control instruction. This study investigates how the sound quality improve by analyzing the played sound through its Q-score

[†] Corresponding Author: Dept. of Electronic Engineering, Kyung Hee University, Korea. (donghani@khu.ac.kr)

* Dept. of Electronic Engineering, Kyung Hee University, Korea. (wonsu0513@gmail.com, jargalbaatar@khu.ac.kr)

Received: July 13, 2016; Accepted: July 17, 2017

after modelling the violin bow on a spring- damper [8, 12]. These researches seek to develop a violin playing robot which can play the violin as similar as humans or even better. Stringed instruments are primarily played by drawing the bow across its strings, requiring a multi-joint robotic arm to play music. Since the robot must be able to control the arm, hand, and fingers, the system is complex and requires an advanced control algorithm. Existing robots played instruments by performing previously stored motions. Thus, the sound quality is significantly changed by the small external force. Previous studies have not dealt with controlling the pressure exerted on the instrument during the path generation of robotic arm and how musicians compensate for their own sound quality while listening to the produced sound, which degrades the robot's performance quality due to not having a self-correction procedure.

This study proposes an auditory feedback framework which allows robots to correct sounds on its own and to overcome this disadvantage.

This study suggests the Gaussian-Harmonic-Quality (GHQ) uses sounds' clarity, accuracy, and harmonic structure in order to decide sounds objectively. Through the experiments, the auditory feedback system improved the performance quality by the robot accordingly, changing the bowing speed, bowing force, and sound point and determining the quality of robot sounds by GHQ sound quality evaluation system.

This paper is organized from sections two through seven. Section 2 introduces the preliminaries of the violin. Section 3 introduces structures of violin playing robot, the preliminaries of the auditory system, and the framework for the auditory feedback system implementation. Section 4 explains the theory of GHQ sound quality evaluation system which has a significant role in determining the sound and evaluation methods. Section 5 emphasizes the importance of the auditory feedback and introduces the validity and reliability of the experiments and the result of adopting the auditory feedback system while playing in the experiments. Section 7 presents future research and the conclusion.

2. Preliminaries of Violin

Violin is the most common instrument and it has the role of the leader in the modern orchestra. The four strings of violin are capable of producing above four octaves, and are able to make every flat and sharp notes, and a microtone. Musical diversity of the violin can articulate heartfelt and lyrical sounds along with lyrical attraction and cheerful tune based on the violinists' playing skills. The violin consists of a body, neck, and the head as shown in Fig. 1. The body consists of top, front, ribs, and back. The arching of its top and back is a major structure to determine the sound of a violin. The bridge helps to transmit the vibration



Fig. 1. The structure of a Violin



Fig. 2. An electric violin and an Amplifier

of the strings to the body and the F-hole which maximize the sounds. The bridge is a significant piece that determines sounds of violin, and it is not in a fixed position like the sound post. All pieces on the violin affect its sounds. The violin has four open strings (G, D, A and E). From the bridge the strings should have a five-degree angle. Each open string is tuned 196, 294, 449, and 660Hz. The tension of the violin strings is approximately 20-25 kg, and the length of violin strings is measured from a tailpiece to a pegs. A violin is played by moving the bow across the tuned strings. Bowing the strings of an instrument causes vibrations to make sound which creates the stick-slip physical phenomenon. Helmholtz [27] investigated the stick-slip phenomenon by bowing technique and recognized vibration was created as a saw-tooth wave form which is known as Helmholtz motion. Bowing on strings creates the tremor when the 'stick' and 'slip' encounter. The 'stick' phase is when the friction of the bow is dragged along the string. The 'slip' phase is when the bow is dragged across the strings and the strings are put into motion. The force is what determines the sound quality. Ample pressure creates the sound of a violin, while slight pressure will cause a screeching sound. The further you get from the bridge one must control the pressure of the violin and must put more pressure to create a seamless sound [11]. Therefore, when the bow is moving away from the violin body there must be more pressure to keep the same friction [8, 9].

This study used an electric violin in Fig. 2, which has an amplified sound compared to the traditional violin. The electric violin is played the same way as the traditional violin; where the bow is moved across the string. The electric instrument contains a built-in line out socket and a

battery. The pickup device translates the vibrations of the strings to electronic signals, and transmits the signals through the speaker to amplify the sound so people can listen to it. A violin is an instrument that generates sound due to the vibration between the bows and strings and generates various sounds by adjusting pitch, timbre, and loudness. The sound has to travel through the sound post into the body of the violin and out the f-holes. Pitch refers to the fundamental frequency of the sound, which indicates the scale and tone. Timbre determines the specific sound or sound characteristics, which depend on the harmonic frequency structure of instrument or voice. Loudness indicates the quantity that measures the intensity of the sound. Among them, timbre is the most important factor affecting the characteristics of the sound, which is associated with bowing speed, bowing force, and sound point.

3. Introduction of Violin Playing Robot.

In this study, a violin playing robot is made using an industrial 6-axis vertically articulated robot arm (RV-2SD in Table 1) as shown in Fig. 3, and manufactured to resemble the size of a human as shown in Fig. 4(a). A 4/4 violin bow for adults is used. To have a fixed sound the violin must have the proper shape because if the figure of



(a)



(b)

Fig. 4. (a) Violin playing robot (b) violin mounting device

the violin is change then sound of the violin will change. To achieve the proper sound the way of mounting the violin to the robot is shown in Fig. 4(b) and manufactured a specialized post for the violin [12, 17]. The robot arm is controlled using TCP/IP communication from the PC, which consists of AC servo motors, its maximum payload is 3kg and standard load is 2kg. The robot arm is mounted on the shoulder as same appearance as humans. A violin bow having a sensor to measure the pressure and vibration on the bow is attached at the end of robot arm.

Table 1. Robot arm features

Item		Specifications
Type		RV-2SD
Degree of freedom		6
Drive system		AC servo motor
Position detection method		Absolute encoder
Arm length	Upper arm	230 mm
	Fore arm	270 mm
Maximum resultant velocity		4000 mm/sec
Load	Maximum	3 kg
	Rating	2 kg
Allowable moment load	Wrist twist (J4)	4.17 N·m
	Wrist pitch (J5)	4.17 N·m
	Wrist roll (J6)	2.45 N·m
Allowable inertia	Wrist twist (J4)	0.18(0.27) kg·m ²
	Wrist pitch (J5)	0.18(0.27) kg·m ²
	Wrist roll (J6)	0.04(0.1) kg·m ²



Fig. 3. An industrial 6-axis vertically articulated robot arm

3.1 Framework of auditory feedback system

Auditory feedback is known as a stuttering therapy method in the medical field, where Delayed Auditory Feedback (DAF) is mainly studied. DAF is a proven medical technique, which reduces the stuttering symptom by 70 percent by repeating the process of recording the patient's voice using microphone and then listening through headphone after 25 to 74 milliseconds of delay.

It helps people to talk or sing a song by determining the accuracy of the sound, if the auditory feedback is fused with visual feedback and somatosensory feedback [3, 23]. This mechanism has been utilized in the process of playing music, and this study proposes a technique that improves the sound quality on its own by using a violin robot.

Fig. 5 shows an overall a violin playing robot system. Pre-programmed command transmits to a control board, which contains F_d a target bowing force, V_s , a target bowing speed, and P_d , a target sound point. A control board controls the violin playing robot arm to follow a target input d and play the violin by an inner control loop. At the same time, an auditory feedback block in outer loop receives an input of violin playing sounds and determines the sound quality through an analog/digital convert and the

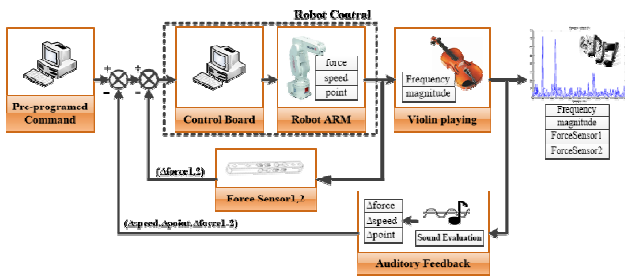

Fig. 5. Block diagram of auditory feedback system

Short Time Fourier Transform (STFT). Based on this auditory feedback, input variation values (ΔV_d , ΔP_d and ΔF_d) to the violin playing robot are subtracted from a pre-programmed command.

In Fig. 5, a Block “Control Board” includes the control board H/W of the violin robot system. It consists of a CORTEX-M3 ARM microprocessor that receives the whole sensor information and processes, and a Window PC application module that controls the robot arm and shows real-time information including sensors and a robot. The CORTEX-M3 ARM microprocessor receives the performance information i.e. the bowing force, bowing speed, and sound point in real-time. It can obtain the bowing force (F) from Force Measurement System and the bow position during play (P) from the Sound Point Measurement System. These values are made into a single protocol and then transmitted to the Window PC application module, in which the auditory feedback determines the performance data and then executes the next action by changing the position of the robot arm using TCP/IP communication. Audio Sensory System, Force Measurement System and Sound Point Measurement System will be explained in detail in the next section.

3.2 Audio sensory system

Violin sound contains a fundamental frequency and a harmonic frequency. Among them, the scale is determined by the fundamental frequency and its magnitude. Therefore, the audio sensory system that records the sound and extracts the value of fundamental frequency and its magnitude in real time should be implemented. Fig. 6 shows a circuit diagram and an implemented circuit to obtain playing sounds which uses an LM386 OP-Amp as an audio power amplifier. In this paper, the Short Time Fourier Transform (STFT) is adapted, which is known as the time-frequency analysis method, which allows examining the information in both in regards to the domain of time and frequency simultaneously. Also, spectrogram is used to monitor the magnitude of signal [11].

The violin generates sounds which are recorded with a 4KHz sampling frequency by the pick-up device that translates the vibrations of the strings to an analog electric signal. After that, the sound is inputted to the ADC and is

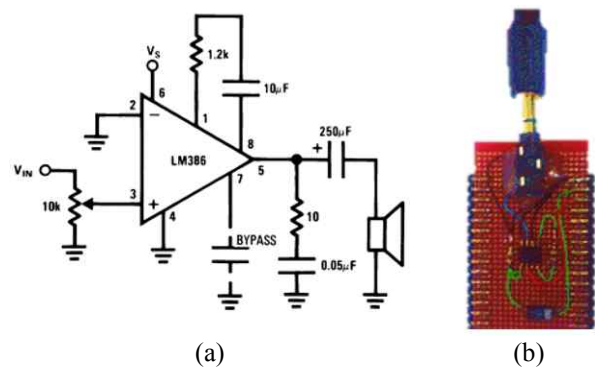

Fig. 6. (a) Sensory system circuit, (b) Implemented audio sensory system

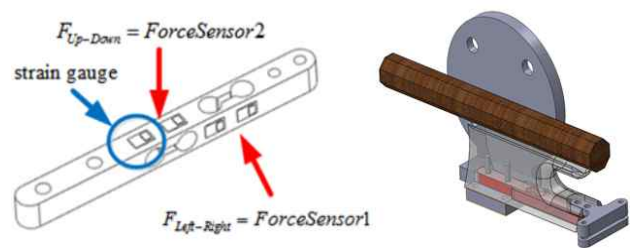

Fig. 7. Two-axis load cell of violin robot

saved at the Direct Memory Access (DMA) to perform the STFT with 30Hz sampling rate.

3.3. Force measurement system

The bowing force should be changed along the distance between the bow and the bridge [8], and it is an important factor to determine the sound quality. In order to measure the force of the bow, the force sensor is attached on the handle of the bow, which is mounted at the end of robot arm as shown in Fig. 7. The force sensor has two binoculars with strain gauge, which measures the drawing force of the bow and the twisting force. The bowing force is measured by using the full-bridge circuit and amplified by 128 times with OP-Amp.

3.4. Sound point measurement system

The bowing force and the bowing velocity should be changed according to the sound point, which also affects the fundamental frequency. the fundamental frequency decreases as the sound point gets further away from the bridge. To measure the sound point, the sound point measurement system as shown in Fig. 8 is implemented to the surface of the violin. Five reflective photo-interrupters are used in a series of 10mm intervals. From the sound point of the bridge, the sound point P1 is 10mm apart, P2 is 20mm, P3 is 30mm, P4 is 40mm and P5 is 50mm. Using this measurement system, the sound point can be measured from the strings in real time.



Fig. 8. Sound Point measurement system

4. GHQ Sound Quality Rating System

In this section, a novel Gaussian-Harmonic-Quality (GHQ) sound quality rating system is developed to quantitatively and objectively evaluate the sound quality of the violin for auditory feedback. This system is based on the instrumental characteristics and the sound evaluation results of 12 professional violin players. The proposed system evaluates the sound quality using three factors: Gaussian factor (f_G), harmonic factor (f_H), and violin-quality factor (f_{VQ}). The Gaussian factor evaluates the sound accuracy using a fundamental frequency and an average magnitude. The harmonic factor evaluates the sound using the ratio of fundamental and harmonic frequency. Lastly, the violin-quality factor evaluates the clarity of sound using the bandwidth of fundamental frequency. The proposed system is applied to a violin robot to analyze the changes in sound depending on the sounding point of violin, bow speed, and bow force. Then the proposed GHQ sound quality rating system is verified through experimental play of open G string from violin expert and violin beginner.

4.1 Gaussian factor (f_G)

Gaussian factor (f_G) evaluates accuracy of the tone by measuring the average of the fundamental frequency of the sound (G_{Freq} , Hz) and its magnitude (G_{Mag} , dB). The accuracy of the tone when the value is close to 195Hz is credited as the standard frequency of open G string.

$$G_{Freq} = \bar{f}_{Peak} = \frac{1}{n} \sum f_{Peak}, G_{Mag} = \bar{M}_{Peak} = \frac{1}{n} \sum M_{Peak} \quad (1)$$

$$f_G = (G_{Freq}, G_{Mag}), \bar{f}_G = \frac{1}{n} \sum f_G$$

4.2 Harmonic factor (f_H)

The structure of the harmonic frequency is different depending on the nature of the instrument, where the tone of each instrument is different even if the same scale is played. Violin harmonics occur at an integer multiple, where is the ratio between the fundamental frequency and harmonic frequency as follows:

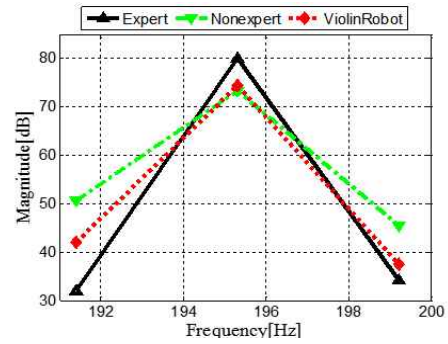

Fig. 9. Violin-Quality factor (f_{VQ}) comparison results

$$f_H = \frac{\text{Harmonic Freq.}}{\text{Fundamental Freq.}} = \frac{\bar{f}_{2nd_Peak}}{\bar{f}_{1st_Peak}} = \sum \frac{f_{2nd_Peak}}{f_{1st_Peak}} \quad (2)$$

$$\bar{f}_H = \frac{1}{n} \sum f_H$$

4.3 Violin-quality factor (f_{VQ})

Based on the Q-factor (Quality factor) representing the sharpness of resonance in the circuit or system, the clarity of sound is evaluated by calculating the sharpness of sound using the bandwidth of fundamental frequency and its magnitude as follows:

$$f_{VQ} = \frac{1}{2} (M_{peak} - \frac{1}{2} (M_{peak-1} + M_{peak+1})) \quad (3)$$

$$\bar{f}_{VQ} = \frac{1}{n} \sum f_{VQ}$$

A Violin-Quality factor (f_{VQ}) is develop to evaluate the fundamental frequency by applying the Q factor. f_{VQ} means the area of a triangle by using the bandwidth of the surrounding frequencies and the peak frequency. This value represents the sharpness and clarity of sound, and it is also an indicator for evaluating the sound and analyzing the fundamental frequency. Fig. 9 shows the results of analysis of the evaluation of the sound played by the novice violinist and the robot using f_{VQ} evaluation system. The result shows that the sharpness and clarity of the sound are different depending on the violinists' skills and verified f_{VQ} assessment.

4.4 GHQ sound quality evaluation

To implement the GHQ sound quality evaluation system suggested in this paper, which can distinguish between a bad sound and a good sound, the violin playing robot in Fig. 4 utilizing the 6-axis industrial robot arm and 30 human violinists (novice and expert) participate in the experiments. An electric violin was used to resistant to external noise and measured the magnitude and the frequency of the fundamental and the harmonics.

The movement distance of the bow is 600mm, from X_S to X_E , played an open G string, whose natural frequency

Table 2. Experimental results of GHQ sound quality evaluation by a violin playing robot the sounding point changes

Sound Point	\bar{f}_G		\bar{f}_H	\bar{f}_{VQ}	GHQ evaluation
	G_{Freq}	G_{Mag}			
P1	755.84	73.37	1.78	12.38	fail
P3	195.23	77.98	1.99	33.24	succeed
P5	195.22	69.29	1.96	9.52	fail

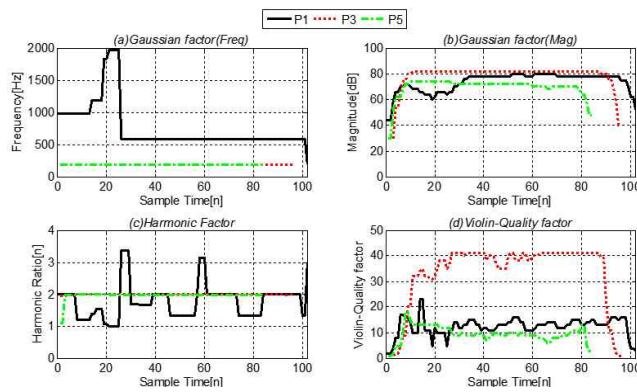

Fig. 10. Experimental results of the GHQ sound quality evaluation by a violin playing robot when the sounding point changes

Table 3. Experimental results of the GHQ sound quality evaluation by a violin playing robot when the speed changes

Bow Speed (mm/s)	\bar{f}_G		\bar{f}_H	\bar{f}_{VQ}	GHQ evaluation
	G_{Freq}	G_{Mag}			
50	191.29	65.06	2.20	12.89	fail
100	197.95	74.38	2.01	17.45	fail
150	195.23	77.98	1.99	33.23	succeed
200	206.13	80.54	1.97	19.82	fail

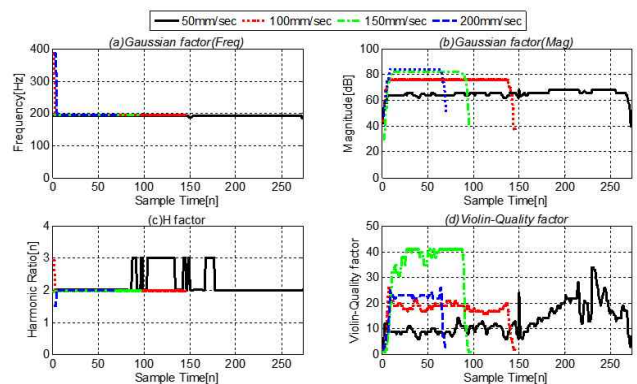

Fig. 11. Experimental results of the GHQ sound quality evaluation by a violin playing robot when the speed changes

is 195Hz.

Table 2 and Fig. 10 show the result of the sound quality evaluation when a bow speed of 150mm/sec and a bow force of 250gf are applied along three different sound points (P1, P3, and P5). Because the sounding point (P1, 10mm apart from the bridge) is small, (G_{Freq}) increases, as already explained in Eq. (1), and a surface noise occurred (black line in Figure. 10 (a), row 1 in Table 3). At sounding point (P5, 50mm apart from the bridge), a raucous noise occurred due to the failure to accurately vibrate strings and thus G_{Mag} decreased; and \bar{f}_{VQ} also decreased due to the wider bandwidth of the fundamental frequency.

Table 3 and Fig. 11 show the sound quality evaluation as the speed changes with the sounding point P3 and the force of the bow, 250gf. When the speed of the bow is higher than 150mm/sec, the vibration of the strings increases, so G_{Freq} increases and \bar{f}_{VQ} becomes unstable as the speed if faster than the strength of the bow (blue line in Fig. 11, row 4 in Table 3). G_{Mag} decreased when the speed of the bow goes below 150mm/sec because it cannot create enough vibration of strings, and \bar{f}_{VQ} also decreased due to the wider bandwidth of the fundamental frequency.

Table 4 and Fig. 12 show how the quality of the sound changes when the speed of the bow is held at 150 mm/sec and a constant sounding point P3 with the bow force change (150gf, 250gf, and 350gf). When the bow force is smaller than 250gf, the vibration is not enough to create a surface noise, and G_{Freq} increases (black line in Fig. 12, row 1 in Table 4). When the bow force increases above 250gf, the vibration created a loud noise due to the failure

Table 4. Experimental results of the GHQ sound quality evaluation by a violin playing robot when the bow force changes

Bow Force (gf)	\bar{f}_G		\bar{f}_H	\bar{f}_{VQ}	GHQ evaluation
	G_{Freq}	G_{Mag}			
150	204.48	74.44	1.98	21.07	fail
250	195.23	77.98	1.99	33.24	succeed
350	192.82	74.46	2.02	17.19	fail

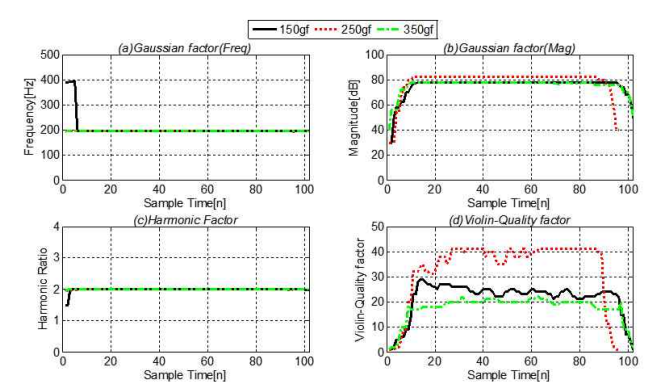

Fig. 12. Experimental results of the GHQ sound quality evaluation by a violin playing robot when the bow force changes

of adjusting the pressure and the bandwidth of the fundamental become wider, and \bar{f}_{VQ} decreases (green line in Fig. 12, row 3 in Table 4).

Based on these experiments, we assure that the Gaussian factor (f_G), harmonic factor (f_H), and violin-quality factor (f_{VQ}) can be the most important factors to evaluate the sound quality from a violin. Also, to make GHQ sound evaluation criteria to decide whether is a good sound or not, vast and various GHQ data from the expert and the non-expert violinists are collected in Table 5.

Through repeated experiments, the best sound results come when the bowing speed is between 100~120mm/sec, the bow force is between 200~250gf, and the sound point is between P2.5~P3. Based on these, four criteria conditions have been created as shown in Eq. (4), which indicates a good quality sound by the GHQ sound quality evaluation system. This means that the quality of the sound can be verified as good if the measurement satisfies these conditions.

Table 5. GHQ sound quality evaluation between experts and non-experts

Player	\bar{f}_G		\bar{f}_H	\bar{f}_{VQ}	GHQ evaluation
	G_{Freq}	G_{Mag}			
Expert #1	195.28	79.22	1.98	20.97	success
Expert #2	195.07	79.66	2.03	23.43	success
Expert #3	195.28	79.22	1.98	20.97	success
Expert #4	195.07	79.66	2.03	23.43	success
Expert #5	197.86	75.00	1.99	22.71	success
Expert #6	195.19	78.61	1.97	20.91	success
Expert #7	204.51	79.49	2.03	19.02	fail
Expert #8	195.18	79.16	1.99	21.10	success
Expert #9	195.19	78.61	1.97	19.91	fail
Expert #10	190.18	77.76	1.92	20.76	success
Non-Ex. #1	218.15	76.48	2.52	15.35	fail
Non-Ex. #2	257.22	77.76	1.92	15.51	fail
Non-Ex. #3	194.59	75.36	2.12	11.87	fail
Non-Ex. #4	243.71	76.77	1.99	13.40	fail
Non-Ex. #5	219.83	76.45	1.94	13.18	fail
Non-Ex. #6	215.20	77.36	1.94	11.26	fail
Non-Ex. #7	246.08	76.84	2.02	11.54	fail
Non-Ex. #8	280.82	75.25	1.86	13.02	fail
Non-Ex. #9	237.12	75.56	1.96	18.36	fail
Non-Ex. #10	287.67	72.07	1.88	14.68	fail

$$\begin{aligned} \bar{f}_{Mode} - 5Hz &\leq G_{Freq} \leq \bar{f}_{Mode} + 5Hz \\ G_{Mag} &\geq 75dB \\ 1.9 &\leq \bar{f}_H \leq 2.1 \\ \bar{f}_{VQ} &\geq 20dB \end{aligned} \tag{1}$$

These include the evaluation about the accuracy of the sound with the fundamental frequency (G_{Freq}) and its magnitude (G_{Mag}). Using a ratio (f_H) of the harmonic structure, the clarity of the sound can be evaluated by using (f_{VQ}). And, \bar{f}_{Mode} indicates the average of the mean of the fundamental frequency. Also, the sound quality from violin experts was good, whereas the sounding point, the bow speed, and the bow force were unstable from violin non-experts and the sound quality was poor. Thus, the effectiveness of proposed GHQ quality evaluation system was verified.

5. Experiment and Results

5.1 Importance of auditory feedback

Violinists learn the sound and timbre that is changed by the force and velocity of the bow, and the sound point by using principles of auditory feedback. To quantitatively measure this phenomenon, the following three experiments are conducted. The violinist played bare handed (Fig. 13(a)) as well as with several layers of gloves (Fig. 13(b)) to determine the significance of force control. To show the

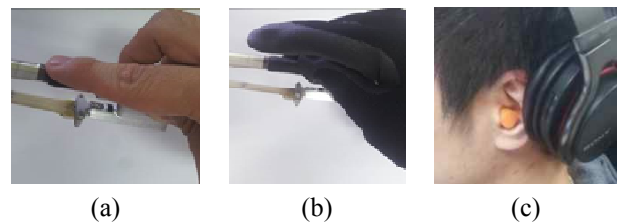

Fig. 13. (a) Normal playing, (b) playing with gloves on (c) Playing with a headphone and earplugs on

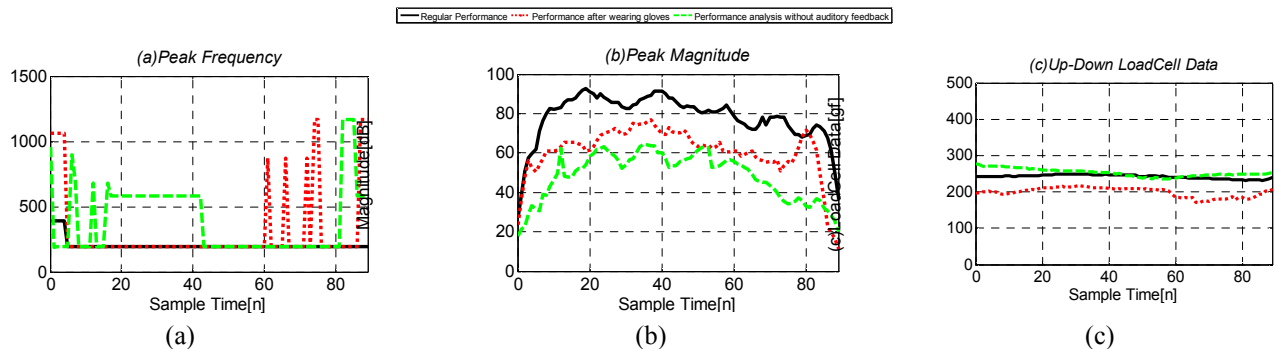

Fig. 14. Experimental results of the significance of auditory feedback, (a) The fundamental frequency, (b) The magnitude of the fundamental frequency, (c) The change of the bow force

importance of auditory feedback, the violinist plays while wearing noise cancelling headphones (Fig. 13(c)).

In these three cases, the moving distance from the end of the bow is held at 600mm and the bowing speed is held constant at 4/4 (80 tempo). The quality is assessed using the GHQ sound quality evaluation system from the previous section for the open G string.

The fundamental frequency, G_{Freq} while wearing gloves is 319.97Hz (Fig. 13(b)) and its magnitude G_{Mag} , 60.76 dB with an average frequency error rate of 64.09% by Eq. (4). The error rate increased about four-times than the normal playing. Without the auditory feedback in the experiment (Fig. 13(c)), the error rate increases even further, approximately, 105.58%. The fundamental frequency, G_{Freq} is 400.88Hz (Fig. 13(a)). The results of these experiments show that auditory feedback is the most important aspect when playing the violin.

5.2 Auditory feedback system using GHQ sound quality evaluation system

The expert violinist plays and listen to his/her violin sound and determine the proper bow force, bow speed, and sound point. Through repetitive practice, experts can improve their ability to generate consistent and good sounds.

The violin playing robot used in this study attempts to mimic the human auditory feedback (Fig. 15). The robot analyses the sound data by GHQ sound quality evaluation system to adjust the sound point, the bow speed, and the bow force in real time. If the sound satisfies the conditions of GHQ in Eq. (4), it is rated as good, otherwise the robot will continue to adjust until it satisfies the conditions of GHQ in Eq. (4).

At the initial try of the robot's performance (black line in Fig. 16, row 1 in Table 6), the pre-set sound point is set to P1 and the bow speed is set to 100mm/sec. The robot compares its own sound data to that obtained from the experts. Using the GHQ sound quality evaluation system, the robot is able to determine that the sound is unstable and that the results do not satisfy the conditions of the GHQ system in Eq. (4). Since G_{Freq} is bigger than that of the

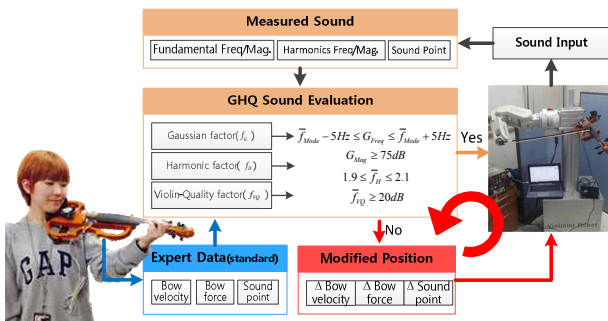

Fig. 15. The whole structure of auditory feedback using GHQ sound quality evaluation system

Table 6. The result of the sound quality evaluation by the violin playing robots

Auditory Feedback	\bar{f}_G		\bar{f}_H	\bar{f}_{VQ}	GHQ evaluation
	G_{Freq}	G_{Mag}			
Try #1	353.74	70.01	1.80	17.89	fail
Try #2	255.10	75.28	1.84	14.21	fail
Try #3	199.03	79.09	2.00	24.37	success

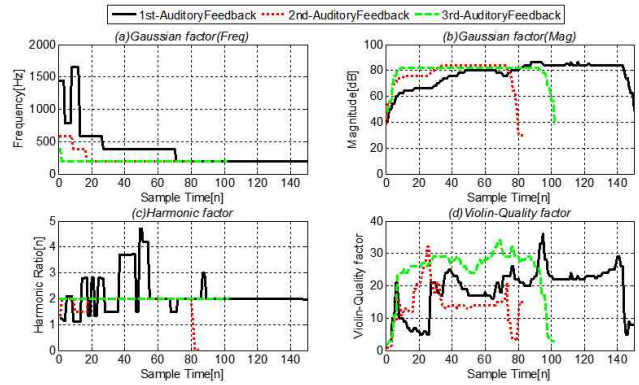

Fig. 16. The result of the experiments of applying Auditory Feedback System

expert, the robot adjusts the play point from P1 to P2.

At the second try (red line in Fig. 16, row 2 in Table 6), although the robot changes the sound point based on the initial try, the sound still does not satisfy the conditions of the GHQ system. The frequency, G_{Freq} , was determined to be lower and failed to vibrate the G string enough and pulled the value of both \bar{f}_{VQ} (the accuracy of the sound) and \bar{f}_H (the ratio of the frequency of the fundamental and the harmonics). Additionally, it determined that the G_{Mag} value was low and decreased the sound point and increased the speed.

At the third try (green line in Fig. 16, row3 in Table 6), using the auditory feedback using the GHQ sound quality evaluation, the robot corrects the bow speed increases the sound point. Through repeated attempts, it continued to decrease the value of G_{Freq} in order to satisfy the criteria of the GHQ system. G_{Mag} is consistently improved until the robot is able to produce a similar sound to the expert's. Finally, it obtained the \bar{f}_H and \bar{f}_{VQ} are improved and satisfy the conditions of the GHQ system.

6. Conclusions & Future Work

In this paper, the effectiveness of auditory feedback was analyzed quantitatively and confirmed the mechanism needed to play the violin. The auditory feedback was introduced to a robotic system developed with the novel STFT-based GHQ sound quality evaluation system and framework to examine and improve the quality of sounds. The robot was able to change the sound point, the bow

force, and the bow speed using auditory feedback system.

This study described the principles and proved the importance of auditory feedback that is crucial to violin performance. It also described the GHQ system using Gaussian factor (f_G), which evaluates accuracy of the tone by measuring the average of the fundamental frequency of the sound (G_{Freq} , Hz) and its magnitude (G_{Mag} , dB), the Harmonic factor (f_H), which in turn uses the structure of fundamental Gaussian distribution, and the violin-quality factor (f_{VQ}), which uses the Q-factor. The conditions for the good sound were decided by using the data from the experts. Using this auditory feedback with GHQ sound quality evaluation, the robot was able to reproduce good sound results. In near future, a robot system that can work with a human player can and should be developed.

Acknowledgements

This research was supported by the Ministry of Trade, Industry & Energy (MOTIE, Korea) under Industrial Technology Innovation Program (No. 10067414, 10070258, 10076477) and the Basic Science Research Program through the National Research Foundation of Korea(NRF) funded by the Ministry of Education (No. 2016 R1D1A1A02936946).

References

- [1] R. Ayres and S. Miller, "the Impact of Industrial Robots," Publication CMU-R1-TR-81-7, Robotics Institute, Carnegie Mellon University, 1981.
- [2] Fujita, M, Kitano, H, "Development of an autonomous quadruped robot for robot entertainment," *Autonomous Robots*, vol. 5, no. 1, pp. 7-18, 1998.
- [3] Yates, Aubrey J, "delayed auditory feedback," *Psychological Bulletin*, vol. 60, no. 3, pp. 213-232, 1963
- [4] Jorge Solis, Atsuo Takanishi, Kunimatsu Hashimoto, "Development of an Anthropomorphic Saxophone-Playing Robot," *Advances in Soft Com-puting*, vol. 83, pp. 175-186, 2010.
- [5] Solis, J., Chida, K., Suefuji, K., Takanishi, A, "The development of the anthropomorphic flutist robot at Waseda University," *International Journal of Humanoid Robotics*, vol. 3, no. 2, pp. 127-151.
- [6] Yoshihiro Kusuda, "Toyota's violin-playing robot," *Industrial Robot: An International Journal*, vol. 35, no. 6, pp. 504-506, 2008
- [7] K. Shibuya, S. Matsuda, A. Takahara, "Toward Developing a Violin Playing Robot - Bowing by Anthropomorphic Robot Arm and Sound Analysis-," *Proc. of 16th IEEE International Symposium on Robot and Human Interactive Communication*, pp. 763-768, 2007.
- [8] Byung-Cheol Min, Eric T. Matson, Jinung An, Donghan Kim, "Improvement of Violinist Robot using a Passive Damper Device," *Journal of Intelligent & Robotic Systems*, vol. 72, no. 3-4, pp. 343-355, 2013.
- [9] JC Schelleng, "The bowed string and the player," *The Journal of the Acoustical Society of America*, vol. 53, no. 1, pp. 26-41, 1973.
- [10] Pierce, John Robinson, "the science of musical sound," *New York: Scientific American Library*, 1983.
- [11] E. Jacobsen, R. Lyons, *The sliding DFT, Signal Processing Magazine*, vol. 20, no. 2, pp. 74-80, 2003.
- [12] Wonse Jo, Hyeonjun Park, Bumjoo Lee, Donghan Kim, "A study on improving sound quality of violin playing robot," *In: Automation, Robotics and Applications (ICARA), 2015 6th International Conference on. IEEE*, pp. 185-191, 2015.
- [13] Koji SHIBUYA, Takashi ASADA, Shigeki SUGANO, "An Algorithm to Convert KANSEI Data into Human Motion," *Proceedings of 1998 IEEE International Conference on Systems Man and Cybernetics (SMC '98)*, pp. 1190-1194, 1998
- [14] Tetsuya OGATA, Akitoshi SHIMURA, Koji SHIBUYA and Shigeki SUGANO, "A Violin Playing Algorithm Considering the Change of Phrase Impression," *Proc. of IEEE International Conference on Systems, Man, and Cybernetics*, 2000
- [15] Park, Hyeonjun, et al. "Development of Robotic Finger Using 3-Axis Load Cell for Violin Playing Robot," 2015.
- [16] Park, Hyeonjun, et al. "A Study about Sound Quality for Violin Playing Robot," *Procedia Computer Science* 56, pp. 496-501, 2015
- [17] Wonse Jo, Donghae Kim, Bumjoo Lee, Donghan Kim, "A Study on Sound Quality Improvement of Violin Playing Robot," the 29th Institute of Control, Robotics and Systems, pp. 652-653, 2015.
- [18] Jea-Yul Yoon, Seok-Pil Lee, Kyeung-Hak Seo, and Hochong Park, "Extracting Predominant Melody from Polyphonic Music using Harmonic Structure," *Journal of the Institute of Electronics and information Engineers*, vol. 47, no. 5, pp. 109-116, 2010.
- [19] J. Woodhouse, P. M. Galluzzo, "The Bowed String As We Know It Today," *Acta Acustica united with Acustica*, vol. 90, pp. 579-589, 2004.
- [20] Diana Young, "A Methodology for Investigation of Bowed String Performance through Measurement of Violin Bowing Technique," Ph.D. Thesis, MIT, 2001.
- [21] Von Helmholtz, H. "Lehre von den Tonempfindungen. Braunschweig, 1862. English edition: On the sensations of tone," 1954.
- [22] Wade-Matthews, Max. *The World Encyclopedia of musical instruments*. Hermes House, 2005.
- [23] Sutton, Samuel, William C. Roehrig, and Jeffrey

Kramer. "Delayed auditory feedback of speech in schizophrenics and normals*." *Annals of the New York Academy of Sciences* 105.15, pp. 832-844, 1964.

- [24] Rossing, Thomas D., F. Richard Moore, and Paul A. Wheeler. *The science of sound*. vol. 3. San Francisco: Addison Wesley, 2002.



Wonse Jo received the B.S. degree in Robotics engineering from Hoseo University, Korea, in 2013, and the M.S. degrees in Electrical engineering, Kyunghee University, Korea, in 2015. Since 2015, he has been with the Department of Electrical Engineering, Kyunghee University, Korea, where he is currently an Assistant Researcher of HRI Lab. His research interests include the areas of Human-Robot Interaction (HRI), Musical instrument playing robot, and application robotics.



Donghan Kim received his B.S., M.S and Ph.D degrees in Electrical Engineering from the Korea Advanced Institute of Science and Technology (KAIST), Daejon, Korea, in 1995, 1998 and 2003, respectively. He has been with the Department of Electrical engineering at Kyung Hee University, where he is currently an associate professor. He was a postdoctoral fellow at University of Illinois at Urbana-Champaign in 2003. His current research interests are in the area of a multi-agent robot system.



Jargalbaatar Yura is M.S. course student in the Department of Electrical engineering at Kyung Hee University. He has received her B.S degrees in Electrical engineering from the Mongolian University of Science and Technology, Mongolia, in 2013, respectively. His current research interests include automation of electrical systems and robotics.