

Maximum Power Tracking Control for parallel-operated DFIG Based on Fuzzy-PID Controller

Yang Gao[†] and Qian Ai*

Abstract – As constantly increasing wind power penetrates power grid, wind power plants (WPPs) are exerting a direct influence on the traditional power system. Most of WPPs are using variable speed constant frequency (VSCF) wind turbines equipped with doubly fed induction generators (DFIGs) due to their high efficiency over other wind turbine generators (WTGs). Therefore, the analysis of DFIG has attracted considerable attention. Precisely measuring optimum reference speed is basis of utilized maximum wind power in electric power generation. If the measurement of wind speed can be easily taken, the reference of rotation speed can be easily calculated by known system's parameters. However, considering the varying wind speed at different locations of blade, the turbulence and tower shadow also increase the difficulty of its measurement. The aim of this study is to design fuzzy controllers to replace the wind speedometer to track the optimum generator speed based on the errors of generator output power and rotation speed in varying wind speed. Besides, this paper proposes the fuzzy adaptive PID control to replace traditional PID control under rated wind speed in variable-pitch wind turbine, which can detect and analyze important aspects, such as unforeseeable conditions, parameters delay and interference in the control process, and conducts online optimal adjustment of PID parameters to fulfill the requirement of variable pitch control system.

Keywords: Doubly-fed induction generator, Rotation speed tracking, Fuzzy adaptive PID control, Pitch control

1. Introduction

Nowadays, there has been an increasing interest in the utilization of wind energy to replace fossil fuel as the wind generation technology is developed and the operational cost is comparable with conventional power plants. However, due to its variable nature, wind power plants pose significant threat to the power system reliability during normal operation and during contingent situations [1]. Nowadays, the doubly-fed induction generator (DFIG) in [2] is now most widely used in wind power plants because of its noticeable advantages, such as the decoupled power control, the diminishment of mechanical dampers, and the improve-ment of power factor. Different models and structures of DFIG are introduced in paper [3], where phase voltage equations are formulated, and a $d-q$ model for stability studies is obtained. In order to achieve the maximum power point tracking (MPPT) control, some control schemes have been researched. For instance, some strategies depend on measuring the wind speed, but it's hard to measure the actual wind speed exactly. The paper [4] applies fuzzy control to the turbine speed, realizing the track of reference speed, but the system steady-state error is

too large to achieve high precision control. The paper [5] proposes rotor speed control based on adaptive fuzzy controller, which generates electromagnetic torque command to the identification controller. But a certain amount of sample data needs to process by the nearest neighbor clustering algorithm, which needs wind turbine rotation measurement to track the optimal speed under different wind speed. However, the uncertainty and variability of wind speed made it incompatible with reality to predict the wind farm output. What's worse, unaccurate estimation of the available wind energy may impose bad effect on the windfarm's modelling, and burdens the participators for wind power. The paper [6] presents a combination dispatch method of electric vehicles (PEVs) and wind energy to solve this problem. The paper [7] proposes to use the datas of numerical weather prediction as inputs, simulating the external characteristics of the wind turbine, which sacrifices the modeling accuracy and computational efficiency.

In order to provide an efficient and economical method for parallel-operated VSCF wind power generator, many research works only focused on using linear vector control, which needs relatively accurate model. The paper [8] has applied the voltage-oriented and field-oriented control with PID controllers in generator-side and grid-side converters for a PMSG system. However, the nonlinear inverter and time-varied model lay a rather high computational burden on buliding the model. The paper [9] introduces a direct

[†] Corresponding Author: Dept. of Electrical Engineering, Shanghai Jiaotong University, Shanghai, China. (jjgybill@sjtu.edu.cn)

* Dept. of Electrical Engineering, Shanghai Jiaotong University, Shanghai, China

Received: May 31, 2017; Accepted: August 1, 2017

torque control, combined with fuzzy PID regulators in the reactive power loop and speed loop to respectively generate the flux reference and electromagnetic torque reference. The paper [10] replaces the conventional PI controller with an optimized fuzzy logic controller to control the stator power flow in a small vertical axis wind turbine. The paper [11] assess the running characteristic of parallel-operated wind farms on bulk power system with the varying wind speed and proposes a fuzzy TOPSIS criteria for modeling the wind power generation, disturbance, operation and wind turbine costs, which ignores the wind speed with poor correlation in the long distance among wind farms. The paper [12] applies fuzzy control to the active power control in rotor side converter and voltage adjustment of wind turbine, which uses errors of active, reactive power and the rate of changes as the input. The paper [13] replaces the conventional PI controllers with an adaptive neuro-fuzzy inference system in DFIG, more suitable for various operating situations. The paper [14] introduces a neuro fuzzy method to the grid side converter in DFIG, of which the output voltage is estimated for reactive power compensation and the active power is regulated by the generator speed adjustment, which are also based on the wind speed measurement.

This paper designs fuzzy controllers to replace the wind speedometer to track the optimum generator speed based on errors of generator output power and rotation speed in varying wind speed. When wind speed is under the rated value, system can estimate the optimal rotating speed without test of wind speed by speedometer and reach the maximum wind-energy capturing. Besides, this paper presents the fuzzy adaptive PID control with tuning parameters online to replace traditional PID control under rated wind speed in variable-pitch wind turbine, which can analyze important aspects like the unpredictable situations, parameters delay and disturbance in the operation, and conducts online optimal adjustment of PID parameters to meet the requirement of variable pitch control system, with fast response and small overshoot.

The rest of this paper is organised as follows: Section II describes VSCF doubly-fed wind power system with the principle, and the transmission system, variable pitch control and in DFIG. Based on the analysis of DFIG power characteristic, the strategy of maximum active power capturing is analyzed. Air instability influences the accuracy of the speed measured by speedometer and decreases the system reliability. Section III proposes to estimate the optimal rotating speed by two fuzzy controllers in parallel-operated control. The first one tracks the maximum power with the errors of generator power output and rotor speed to produce reference speed, achieving the maximal wind energy capturing. The second one realizes speed closed-loop control, which is based on the error and error rate of speed to adjust the stator torque current. Section IV contains a discussion on simulation results in DFIG parallel operation and compares

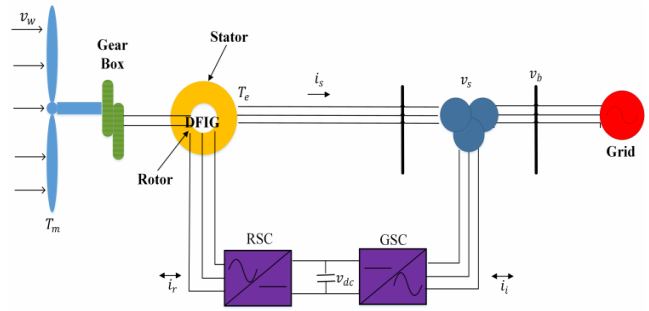

Fig. 1. Grid-connection of doubly-fed induction generator

the performance between fuzzy self-adaptive control and PID control in variable-pitch wind turbine.

2. Speed Tracking Control of Doubly-fed Induction Generator

The VSCF doubly-fed wind power system consists of wind turbine, gear box, doubly-fed induction generator, transformer, dual PWM converters and filters, as shown in Fig. 1. Among these, induction generator is a wound induction generator, whose stator is directly connected to the grid, and rotor is connected to grid via dual PWM inverters [15, 16].

2.1 Transmission and variable pitch control in DFIG

2.1.1 Transmission system

Turbine speed is usually lower, while the DFIG always operate at synchronous speed, therefore, the gear box needs setting between the wind turbine and generator.

The transmission model is as follows:

$$T_m - \gamma T_e = \frac{(J_m + \gamma^2 J_e) d\omega}{dt} + (B_m + \gamma^2 B_e) \omega \quad (1)$$

where T_m is the torque which transfers from rotation axis to rigidity gear (N·m); T_e is the electromagnetic torque of generator (N·m); J_m is the wind turbine's inertia; J_e is the generator's rotation inertia; B_m , B_e respectively represents mechanical damping of wind turbine and generator; γ is the growth rate ratio of gearbox.

2.1.2 Variable pitch system

Pitch actuator is typically implemented by a hydraulic system, since the blade's inertia is large, and pitch actuator approximately equals to a first-order inertia system.

$$\beta = \beta_r / (\tau s + 1) \quad (2)$$

where β_r is the command value of pitch angle (degree); τ is a time constant(s).

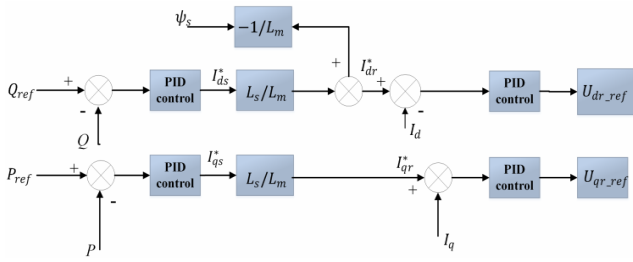

Fig. 2. Block diagram of traditional PID controller

2.1.3 Traditional PID control in grid-connected DFIG

The machine side controller, consisting of a reactive power controller and an active power controller, is commonly a two stage controller as illustrated in Fig. 2. It operates in either stator flux or stator-voltage oriented reference frame and hence the *q*-axis current component represents active power and the *d*-axis component represents reactive power.

There are two closed-loops in the system. One is the power control loop and the other is the current control loop. In the power control loop, the active power command *P* and the reactive power command *Q* are compared with their feedback values. Then the values of difference are controlled through PID controllers to get the reactive component command *I_{ds}** and the active component command *I_{qs}** of the stator current.

2.1.4 Design of fuzzy controller in parallel operation

If wind speed can't reach the rated value, output power of DFIG will not obtain the rated power, either. In this case, absorption the wind power as much as possible is the main object. The usual approach is to measure the wind speed via anemometer, and set the generator speed based on the optimal tip speed ratio. However, due to the complexity of the wind farm condition, the measurement of wind speed must be accurate enough for adjusting the rotation speed of generator. A traditional strategy is to set DFIG in power control situation and obtain an optimal reference of active power as a formula of the wind turbine speed.

$$P_{max} = \frac{\pi}{2} C_{pmax} \rho R^2 \left(\frac{\omega_w R}{\lambda_{opt}}\right)^3 = K_{opt} \omega_w^3 \quad (3)$$

$$P_s^* = \frac{P_{max}}{1-s} = \frac{K_{opt} \omega_w^3}{1-s} \quad (4)$$

Where $K_{opt} = \frac{\pi}{2} C_{pmax} \rho \frac{R^5}{\lambda_{opt}^3}$, P_{max} is maximum wind energy, C_{pmax} is maximum power coefficient; λ_{opt} is optimum tip speed ratio, P_s^* is generator active power reference, *s* is slip rate.

Evidently, K_{opt} mostly relies on the wind turbine parameters and air density. The turbine conversion factor

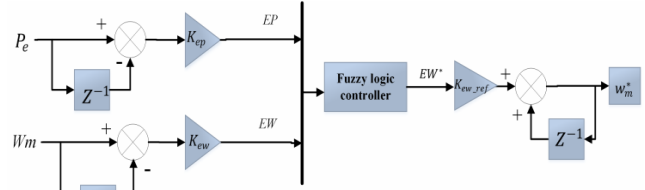

Fig. 3. Block diagram of speed tracking controller FLC1

and the optimum tip speed ratio for C_{pmax} and λ_{opt} are decided by turbine parameters. Besides, the climatic conditions also affect the term ρ , which may has significant shifts in different seasons. So the K_{opt} will not lead to the real optimal power point all the time. A novel method without the need of the turbine parameters and air density in MPPT control is presented in this chapter and above all, this control method has superior dynamic performance in the changing wind speed environment.

2.2 Control strategy of generator speed tracking controller

The control strategy is in the direct speed control mode of DFIG. The speed reference is decided by fuzzy logic controller FLC1, which takes the generator output power increment ΔP_e and turbine rotating-speed increment $\Delta \omega$ as inputs. The structure of FLC1 is shown in Fig. 3.

The working principle is as follows: When the wind velocity keeps constant, the turbine output power is mainly affected by the rotating speed. So if ΔP_e and $\Delta \omega$ are positive, which means the turbine working point is on the left side of the maximum power point, and the ω should be increased again. But, if positive $\Delta \omega$ causes negative ΔP_e that means the turbine working point has already moved over the maximum power point, so the $\Delta \omega$ should be decreased. In this way, the maximum power point can be reached finally.

Supposing EP, EW, EWref are language values after fuzzy, whose domain is defined as [-6, 6] and divided into [-6, -5, -4, -3, -2, -1, 0, +1, +2, +3, +4, +5, +6], a total of 13 files, whose fuzzy subset is defined as [negative big, negative middle, and negative small, zero, positive small, positive middle, positive big] that is [NB, NM, NS, ZE, PS, PM, PB]. As the wind energy conversion deviation is relatively large, the EP, EW, EWref variables use lower

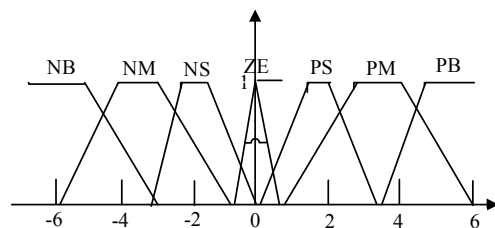

Fig. 4. Membership functions of EW, EP, and EWref

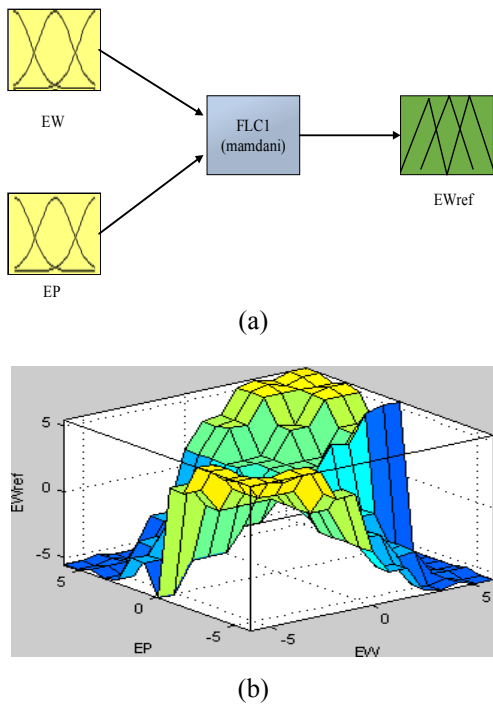

Fig. 5. System frame and relationship surface of FLC1

resolution “pimf” membership function, shown in Fig. 4. The fuzzy system frame and controller input-output relationship surface are shown in Fig. 5.

2.3 Control strategy of generator closed-loop speed controller

Tracking doubly-fed generator speed via fuzzy controller FLC1, the reference speed value can be obtained. Compared the reference speed with actual one, the speed error signal can be obtained: $EW_r = W_{ref} - W_r$ and the change speed deviation rate is $ECW_r = EW_r(n) - EW_r(n-1)$. Doubly-fed generator closed-loop speed fuzzy controller’s inputs are EW_r and ECW_r , and the output is the error of torque current component $Eit1$. Similar to the speed tracking fuzzy controller, the domains of EW_r , ECW_r and $Eit1$ are $[-6, 6]$, whose fuzzy subset are defined as [negative big, negative middle, and negative small, zero, positive small, positive middle, positive big] that is [NB, NM, NS, ZE, PS, PM, PB]. The rules of fuzzy controller FLC2 are as follows:

- If the measurement of rotor speed is larger than the reference value, EW_r is negative and vice versa. Error of change rate and change direction all depend on ECW_r .
- If ECW_r equals zero, which means in the same sampling intervals, $EW_r(n)$ is same, and the change of $Eit1$ is decided by the change of EW_r . If EW_r is negative, decreases $it1$, so $Eit1$ will be negative.
- If EW_r equals zero, the negative error of previous speed $EW_r(n-1)$ is ECW_r . If ECW_r equals positive big, that means the change rate of rotation speed is large, and the previous speed measurement is greater than the

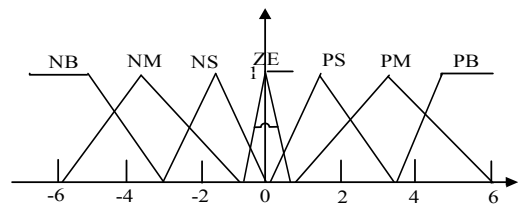

Fig. 6. Membership functions of EW_r , ECW_r , and $Eit1$

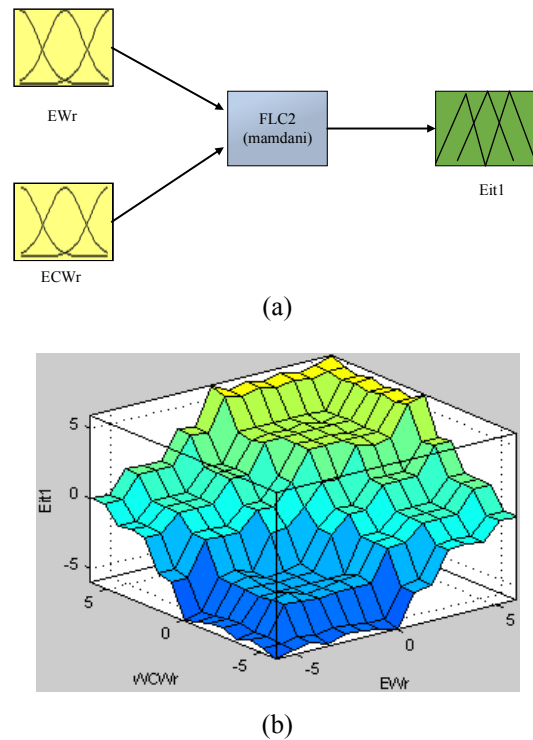

Fig. 7. System frame and relationship surface of FLC2

reference speed. To avoid the large overshoot caused by the rapid change rate, $it1$ should be increased to make $Eit1$ equals positive big.

As the wind energy conversion deviation is relatively large, the EP , EW , EW_{ref} variables use lower resolution “pimf” membership function, shown in Fig. 6.

The fuzzy system frame and relationship surface of controller input and output are shown in Fig. 7.

3. Doubly-fed Induction Generators Parallel-operated Control

MPPT control without wind speed measurement exists two different methods: 1) directly or indirectly estimate wind speed from the relationship between the wind energy utilization coefficient and active power, which requires many experiments and simulations to obtain the relationship curve between them, while different wind turbines always exist different characteristic curves, increasing the control

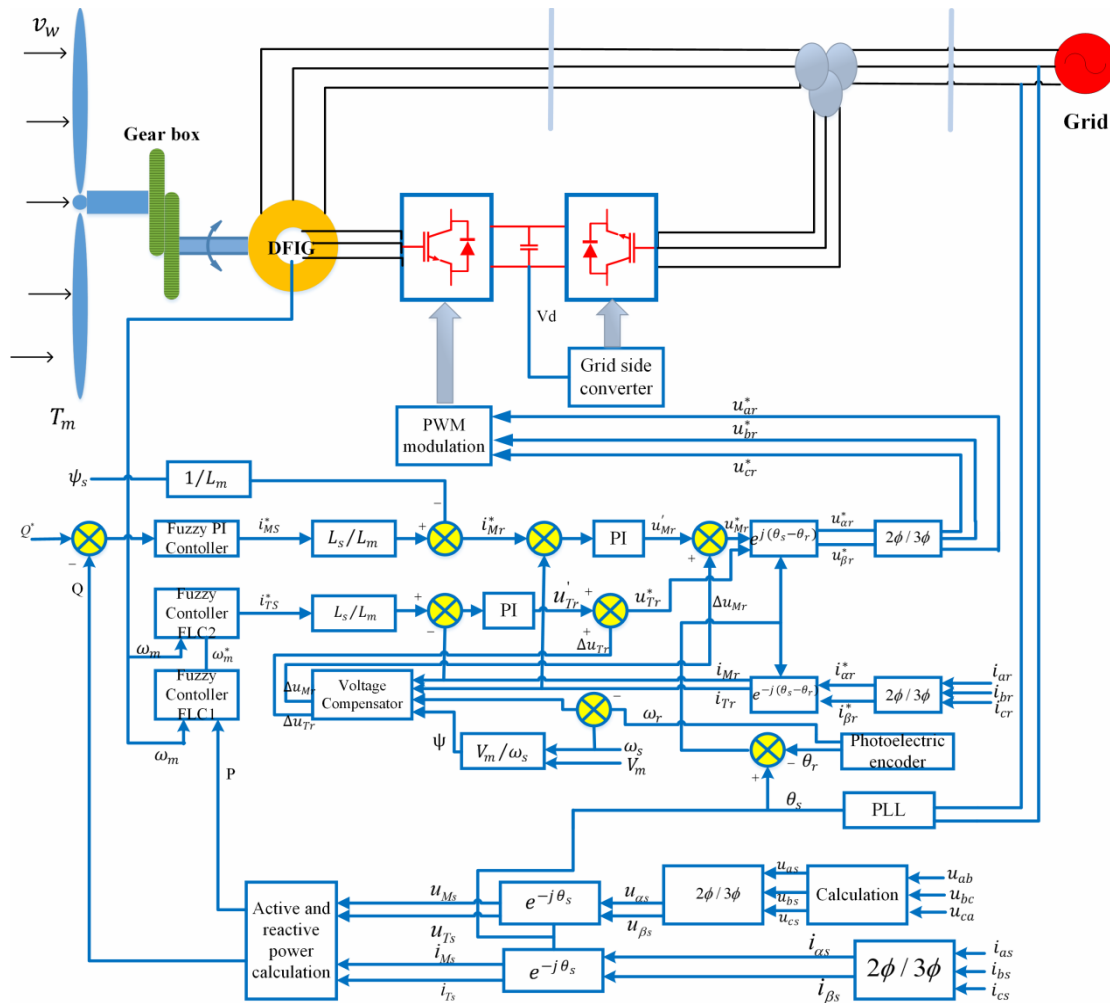

Fig. 8. Parallel-operated control for doubly-fed induction generators

expense; 2) accurately estimate the optimum value of reference speed based on intelligent control without wind speed measurement, as shown in Fig. 8.

In the outer loop of power control, the reactive power reference value Q^* and the feedback value of reactive power Q are compared; the fuzzy PI controller is processed to obtain a reactive current reference value of the stator i_{Ms}^* . In the fuzzy controller FLC1, the output power increment $\Delta P(n-1)$ and speed increment $\Delta\omega(n-1)$ at per unit time are set as the input, the reference speed increment $\Delta\omega_{ref}(n)$ is the output. Based on the fuzzy rules, if the previous speed increment makes the positive growth of power output, the reference speed will maintain the same growing direction of previous speed increment, otherwise, the opposite direction. The reference speed is $\omega_{ref}(n) = \omega_{ref}(n-1) + \Delta\omega_{ref}$, in which $\omega_{ref}(n)$ is the reference speed of moment n . Then comparing the generator's reference speed ω_m^* with the actual feedback ω_m through FLC2, active current reference value i_{Ts}^* is obtained. Then the current difference is converted via PI controller to gain the voltage component references u_{Mr}^* and u_{Tr}^* , and then by applying voltage compensation

respectively, the rotor voltage reference u_{Mr}^* and u_{Tr}^* is achieved. Through two-phase to three-phase rotating coordinate transformation, three-phase rotor voltage u_{ar}^* , u_{br}^* and u_{cr}^* are achieved. Finally, after the PWM conversion, active and reactive power is decoupled.

3.1 Fuzzy adaptive PI power regulator design

3.1.1 Membership Determination

The fuzzy PI controller is based on the error e and the change of error ec to adjust parameters and achieve PI parameters for online self-tuning, whose function can be written below.

$$u = k_e \cdot e + k_{ec} \cdot ec \tag{5}$$

The fuzzy-PI output is:

$$y = k_p \cdot u + \int k_i \cdot u \tag{6}$$

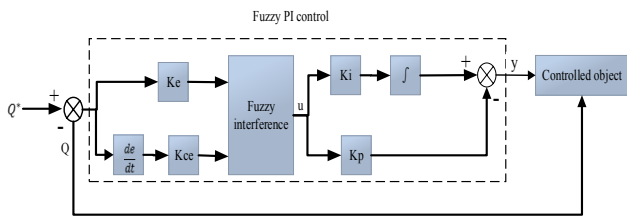

Fig. 9. Fuzzy-PI controller in reactive power loop

Where: k_e is the gain of the reactive power error, k_{ce} is the gain of the change of power error k_p is the proportional factor; k_i is the integral factor, and u is the fuzzy output. The Fuzzy-PI controller in reactive power loop is presented in Fig. 9.

3.1.2 The principle of PI parameter tuning

The structure and algorithm of PI controller have been generally identified, where the choice of PI control parameters k_p, k_i decide the control quality, considering the system response speed, stability and the effect on different error e and the error change rate e_c in the control process.

The tuning rules of k_p, k_i are as follows:

- If absolute value of e is large, take a larger k_p and a smaller k_i (in order to increase the response speed) so that $k_i = 0$ (in order to avoid large overshoot, eliminating the integral effect).
- If absolute value of e is medium, take a smaller k_p (in order to make the system overshoot smaller), and take a proper value of k_i .
- If absolute value of e is small, take a larger k_p and k_i (in order to make the system more steady) so as to avoid fluctuation near the equilibrium point.

4. Simulation

4.1 Simulation result analysis

In Fig. 10 the actual wind speed includes three parts: basic random wind speed (6m/s), peak gust speed (1m/s), and step speed (1m/s). In Fig. 11 solid line is reference generator speed of DFIG, while dotted line is actual speed. No matter how wind speed changes, doubly-fed generator can fast-track the reference speed of the controller, enabling the generator speed to follow changes in wind speed, and adjust the turbine speed, maintaining optimum tip speed ratio λ_{opt} . Fig. 12 shows the DC voltage has risen from 800V to 1200V and quickly stabilizes with small overshoot at the beginning. Fig. 13 and Fig. 14 show the fuzzy adaptive control can make the stator's active power quickly track the wind speed changes, while the reactive power is stabilized near zero, achieving active and reactive power decoupling. Fast response, high precision,

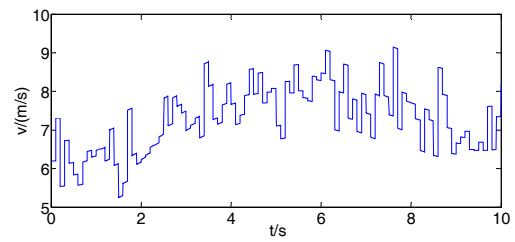

Fig. 10. Simulation results of wind speed

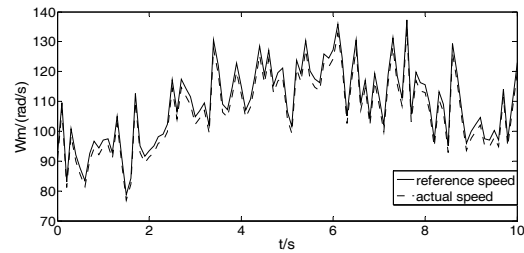

Fig. 11. Rotation speed of doubly-fed induction generator

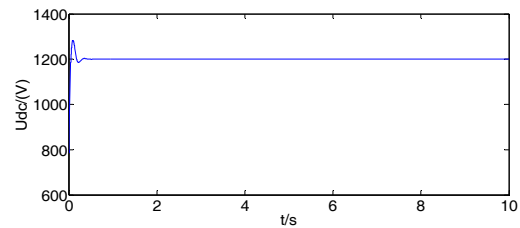

Fig. 12. Voltage of DC bus

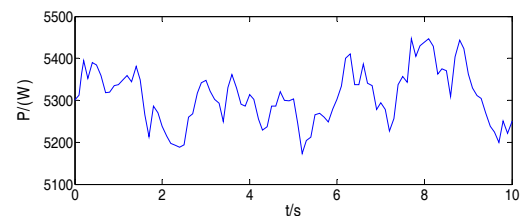

Fig. 13. Fuzzy control of the stator active power output

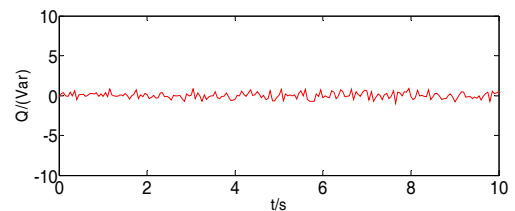

Fig. 14. Fuzzy control of the stator reactive power output

strong adaptability and highly robustness are verified by the proposed strategy.

Currently, in the parallel operation of wind power, PID controller is taken to control the pitch angle of wind turbine above the rated wind speed. Although PID controller can operate in a wide range of wind speed, the effect is not very satisfactory. The reasons are as follows:

- When wind turbine operates above the rated wind speed, the character of wind energy shows very strong nonlinearity, which varies with the cube of its speed. In the wind turbine system, the relationship between the set values of pitch angle β and the absorption power P_r exist strong nonlinearity. The effect of pitch angle on power output is very different in various wind speed. The control effect of one set of PID parameters may be well under the rated wind speed, but it may turn bad in the case of cut-out condition.
- PID controller is a feedback controller, which can only work with the large deviation. Besides, the inertia and delay of pitch controller inevitably impose bad impact on the outpower fluctuation, with large overshoot and regulation time.

4.2 Mathematical model for wind turbine

Based on the characteristic of turbine blades, wind energy conversion factor C_p shows relationship between tip speed ratio λ and pitch angle β .

$$C_p(\lambda, \beta) = (0.44 - 0.0167\beta) \sin\left[\frac{\pi(\lambda - 3)}{15 - 0.3\beta}\right] - 0.00184(\lambda - 3)\beta \quad (7)$$

The wind power absorbed by wind turbine can be described below:

$$P_r = \frac{1}{2} \rho S C_p(\lambda, \beta) v^3 \quad (8)$$

Where: P_r is the wind energy absorption (W); ρ -air density (kg/m^3); S -rotor swept area (m^2); λ -tip speed ratio; C_p -rotor power coefficient; β -blade pitch angle (degree); v -wind speed (m/s).

Assume that the variable pitch blades are constant. The model of wind turbine can be described below:

$$J_r \frac{d\omega_r}{dt} = T_r - N \cdot T_m \quad (9)$$

Where: J_r is rotational inertia of rotor ($\text{kg}\cdot\text{m}^2$); ω_r -angular velocity of rotor (rad/s); T_r - start-up torque of wind turbine (N·m); N -drive ratio of gear box; T_m -the mechanical torque from rotation shaft to the gear box (N·m).

The function of the rotor torque with wind power and rotation speed can be represented below:

$$T_r = \frac{P_r}{\omega_r} = \frac{1}{2} \rho \pi R^2 C_p(\lambda, \beta) \frac{v^3}{\omega_r} \quad (10)$$

4.3 Mathematical model for generator

The doubly-fed generator regulates its variable speed via

the electromagnetic torque.

$$T_e = \frac{g m_f U_1^2 r_2'}{(g m_g - \omega_1) \left[(r_1 - \frac{C_1 r_2' \omega_1}{g \omega_g - \omega_1})^2 + (x_1 + C_1 x_2')^2 \right]} \quad (11)$$

$$P = T_e \omega_g \quad (12)$$

Where: g is number of generator pole pairs; m_f -number of phases; U_1 -the grid voltage; C_1 -the correction factor; ω_1 -synchronous speed of generator (rad/s); r_1, x_1' are stator's resistance and leakage reactance; r_2', x_2' is resistance and leakage reactance of rotor winding after reduction, respectively. The generator torque formula is:

$$J_g \frac{d\omega_g}{dt} = T_m - T_e \quad (13)$$

Where: J_g is generator's rotational inertia ($\text{kg}\cdot\text{m}^2$); T_e -counter torque of generator (N·m). Relationship between rotor shaft angular velocity ω_r and generator speed ω_g can be indicated below:

$$\omega_r = \frac{\omega_g}{n} \quad (14)$$

4.4 Modeling for short-term wind speed

Based on Kamal's spectrum, random wind speed can be demonstrated as a response signal of band-limited white noise coming through Kamal filter $H(s)$, which is shown below:

$$H(s) = \frac{1.032s + 1.2493}{2.7463s^2 + 3.7593s + 1} \quad (15)$$

4.5 Design of fuzzy adaptive PID controller

Fuzzy adaptive PID controller combines fuzzy reasoning with PID control technology, detecting the errors of e and change rate ec in operation. Based on fuzzy theory, it will modify k_p, k_i, k_d on line, as shown in Fig. 15.

Assuming that wind turbine is rated at 1500kW, error e

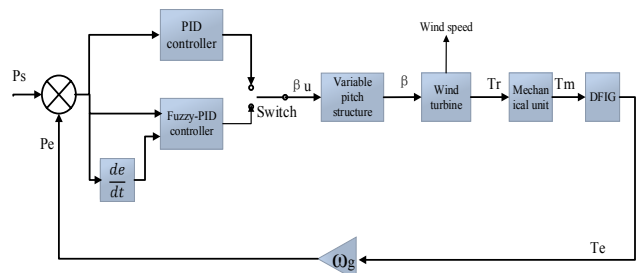

Fig. 15. Control diagram of variable pitch wind turbine

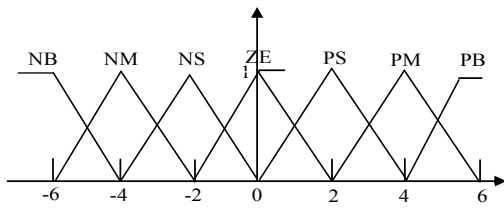

Fig. 16. Membership functions of e, ec

and error rate ec are considered as inputs and $\Delta K_p, \Delta K_i, \Delta K_d$ are outputs. We quantify e, ec to the fuzzy set $X = [-6, -5, -4, -3, -2, -1, 0, 1, 2, 3, 4, 5, 6]$, and the fuzzy subset of $e, ec = \{NB, NM, NS, ZE, PS, PM, PB\}$ (all subjects are normal distribution).

Since the variable pitch absorption generally requires error less than 10% of its rated power, so the error's basic domain is $[-150kW, 150kW]$. If $-150 < e \leq 150$, it is ZO; if $150 < e \leq 750$, it is PS; If $750 < e \leq 1500$, it is PM; If $e > 1500$, it is PB; If $e < -1500$, it is NB; If $-1500 < e \leq -750$, it is NM; If $-750 < e \leq -150$ it is NS. Membership functions are triangular function, and membership function curve is shown in Fig. 16.

For variable pitch control requirements, the fuzzy control rules of wind turbine above rated wind speed are made as follows:

- If e is NB or NM and Δe is NS, NM, NB or ZE, then increase the pitch angle as PB.
- If e is NM or NB and Δe is PS, then increase the pitch angle as PM.
- If e is NM or NB and Δe is NS, then increase the pitch angle as NM.
- If e is NM or NB and Δe is PS, PM, PB or ZE, then increase the pitch angle as NB.

4.6 Implementation of modeling of wind farm output

For a doubly-fed induction generation system, the process of modeling the control system is described as follows:

Step 1 Build the wind speed model with the band-limited white noise coming through Kamal filter $H(s)$.

Step 2 Determine the relationship between the input of wind speed and the rated speed.

Step 3 If the wind speed is less than the rated speed, select fuzzy PID controller to switch 1, changing the stator voltage of generator to adjust the electromagnetic torque, and generator speed to run in optimum tip speed ratio, so as to achieve maximum output power. The switch 2 is held to keep the pitch angle constant.

Step 4 If the wind speed is larger than the rated speed, fuzzy PID connected to switch 2 works by regulating the pitch angle based on the actual power and rated power deviation, so that the output power is always held at rated power. The switch 1 is held to the reference voltage of generator stator.

The flowchart of the proposed modeling process is

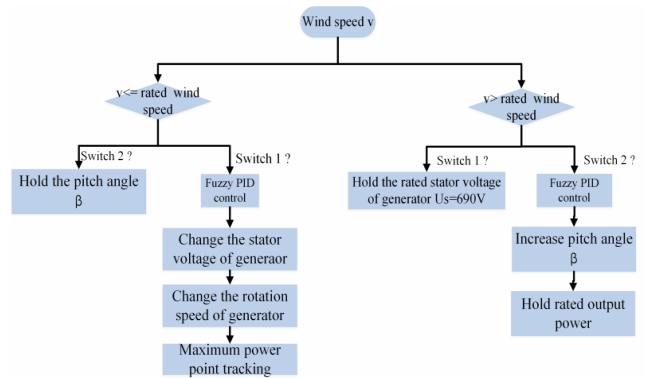

Fig. 17. Flowchart of fuzzy PID control in wind turbine

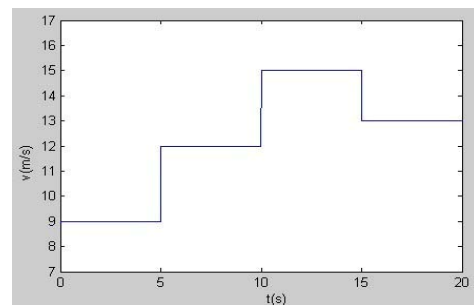

Fig. 18. Step wind input signal

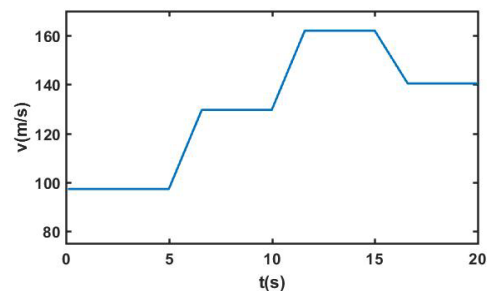

Fig. 19. Rotation speed of DFIG

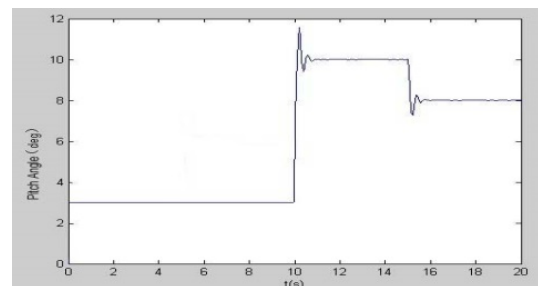

Fig. 20. Pitch angle output of PID control

shown in Fig. 17. Fig. 18-20 show that during the time 0~5s, the wind speed is 9 m/s, less than the rated wind speed, and the rotation speed of DFIG is about 95m/s, which comes through the gear box of wind turbine, while the pitch angle control system does not start working, remaining as 3° near the initial position.

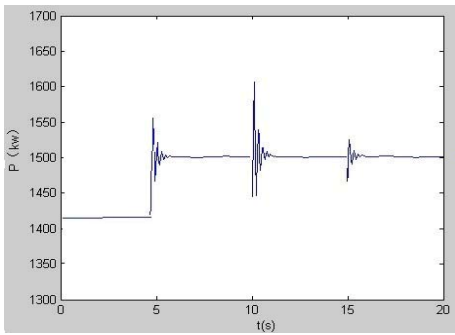

Fig. 21. Output power of PID control

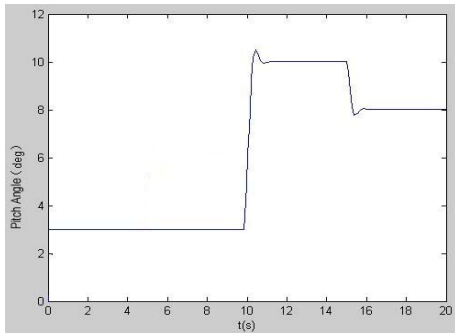

Fig. 22. Pitch angle output of fuzzy control

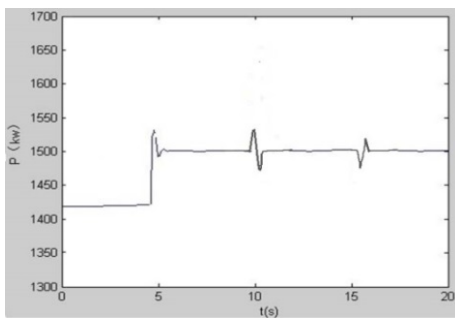

Fig. 23. Output power of fuzzy control

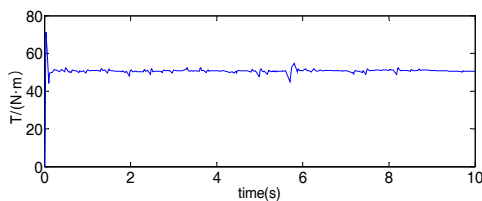

Fig. 24. Conventional PID control of the torque output

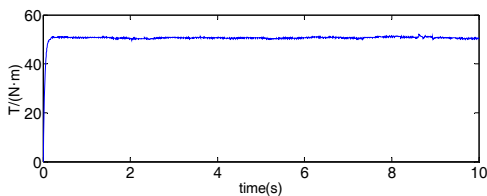

Fig. 25. Fuzzy PID control of torque output

At this time the power is the maximum power at the optimum tip speed ratio; When $t=5\sim 10s$, the wind speed reaches the rated wind speed of 12 m/s, while the pitch angle is still constant, the power reaches the rated power 1500kW; When $t=10\sim 20s$, wind speed is greater than the rated wind speed, but less than the cut-out wind speed, pitch angle changes correspondingly and the power is held at the rated power. Compared with the PID control in Fig. 21, the curves of pitch angle and output power with fuzzy PID control are more stable, with less fluctuation in Fig. 22 and 23.

Fig. 24 and Fig. 25 show that response of fuzzy PID control system for the torque output is faster, more accurate, less fluctuation, and the system is easier to reach steady state, compared with the traditional PID control. Fig. 26 simulates the actual wind speed, and Fig. 27-29 simulate the wind turbine model, the pitch angle output, and active power output in fuzzy PID control.

Simulation results show that the fuzzy PID controller is more robust than a conventional PID controller against parameter variation and uncertainty, with fast dynamic response, good robustness and low dependence on the model parameters. The precision of torque control has been effectively improved, so that the wind turbine operates in the best torque at the maximum wind power point.

Conclusion

Fuzzy adaptive control scheme of variable-pitch wind turbine and DFIG for wind power generation has been proposed and simulated in this paper. The proposed control algorithm can achieve the decoupling control of the active and reactive power, further achieving the maximal wind energy capturing.

The main findings of the paper are as follows:

- Based on the relationship between turbine speed and active power, a novel tracking control strategy is proposed, which also considers wind velocity for better dynamic wind energy tracking performance.
- Compared with the PID control, the fuzzy adaptive PID control in variable-pitch wind turbine can detect and analyze key factors, such as unpredictable conditions, parameters delay and interference in the control process, and conducts online optimal adjustment of PID parameters to meet the requirement of variable pitch control system, fast response and small overshoot.

Acknowledgments

This work was supported by National Natural Science Foundation of China (51577115), the National Key Research and Development Project (2016YFB0901304) and Shanghai Science and Technology Committee (16DZ1203504).

References

- [1] Aissaoui, Ghani A, Abid, et al, "A Fuzzy-PI control to extract an optimal power from wind turbine," *Energy Conversion & Management*, vol. 65, no. 1, pp. 688-696, Jan.2013.
- [2] Liu Y, Wu Q H, Zhou X X, "Co-ordinated Multiloop Switching Control of DFIG for Resilience Enhancement of Wind Power Penetrated Power Systems," *IEEE Transactions on Sustainable Energy*, vol. 7, no. 3, pp. 1089-1099, Jul.2016.
- [3] Ramirez-Gonzalez M, Malik O, Castellanos-Bustamante R, et al, "Conventional and fuzzy PODCs for DFIG-based wind farms and their impact on inter-area and torsional oscillation damping," *IET Renewable Power Generation*, vol. 11, no. 2, pp. 334-340, Jan.2017.
- [4] Hu J, Huang Y, Wang D, et al, "Modeling of Grid-Connected DFIG-Based Wind Turbines for DC-Link Voltage Stability Analysis," *IEEE Trans. on Sustainable Energy*, vol. 6, no. 4, pp. 1325-1336, Jun. 2015.
- [5] Ghosh S, Kamalasan S, "An Energy Function-Based Optimal Control Strategy for Output Stabilization of Integrated DFIG-Flywheel Energy Storage System," *IEEE Transactions on Smart Grid*, vol. 8, no. 4, pp. 1922-1931, Jul.2017.
- [6] Ansari J, Jamei M, Kazemi A, "Integration of the wind power plants through a novel, multi-objective control scheme under the normal and emergency conditions," *International Transactions on Electrical Energy Systems*, vol. 26, no. 8, pp. 1752-1782, Jan. 2016.
- [7] Xu J, Sun H, Gao W D, et al, "Modeling of wind farm output considering wind speed spatiotemporal distribution and wind turbine operational statuses," *International Transactions on Electrical Energy Systems*, 2016, vol. 26, no. 7, pp. 1526-1539, Nov. 2015.
- [8] Tripathi S M, Tiwari A N, Singh D, "Optimum design of proportional-integral controllers in grid-integrated PMSG-based wind energy conversion system," *International Transactions on Electrical Energy Systems*, vol. 26, no. 5, pp. 1006-1031, Aug. 2016.
- [9] Zhu D, Zou X, Deng L, et al, "Inductance-emulating Control for DFIG-Based Wind Turbine to Ride-through Grid Faults," *IEEE Transactions on Power Electronics*, vol. 32, no. 11, pp. 8514-8525, Dec, 2016.
- [10] Kaloi G S, Wang J, Baloch M H., "Dynamic Modeling and Control of DFIG for Wind Energy Conversion System Using Feedback Linearization," *Journal of Electrical Engineering & Technology*, vol. 11, no. 5, pp. 1137-1146, Sep.2016.
- [11] Lee S E, Won D J, Chung I Y, "Operation Scheme for a Wind Farm to Mitigate Output Power Variation," *Journal of Electrical Engineering & Technology*, vol. 7, no. 6, pp. 869-875, Nov.2012.
- [12] Patnaik R K, Dash P K, Mahapatra K, "Adaptive terminal sliding mode power control of DFIG based wind energy conversion system for stability enhancement," *International Transactions on Electrical Energy Systems*, vol. 26, no. 4, pp. 750-782, Jun.2015.
- [13] Byeon G, Park I K, Jang G, "Modeling and Control of a Doubly-Fed Induction Generator (DFIG) Wind Power Generation System for Real-time Simulations," *Journal of Electrical Engineering & Technology*, vol. 5, no. 1, pp. 61-69, Mar.2010.
- [14] Govindaraj N, Raghava D, "Doubly Fed Induction Generator Based Wind Turbine with Adaptive Neuro Fuzzy Inference System Controller," *Asian Journal of Scientific Research*, vol. 7, no. 1, pp. 45-55, Jan.2014.
- [15] Du W, Bi J, Cao J, et al, "A Method to Examine the Impact of Grid Connection of the DFIGs on Power System Electromechanical Oscillation Modes," *IEEE Transactions on Power Systems*, vol. 31, no. 5, pp. 3775-3784, Sep. 2016.
- [16] Lee H, Kim J, Hur D, et al, "Inertial Control of a DFIG-based Wind Power Plant using the Maximum Rate of Change of Frequency and the Frequency Deviation," *Journal of Electrical Engineering & Technology*, vol. 10, no. 2, pp. 496-503, Mar. 2015.



Yang Gao He is currently working towards the Ph.D. degree at Dept. of Electrical Engineering, Shanghai Jiaotong University, Shanghai, China. His research interests include HVDC technology, microgrid, and multi-agent system in energy internet.



Qian Ai He received the Ph.D. degree in electrical engineering from Tsinghua University, in 1999. After spending one year at Nanyang Technological University, Singapore and two years at University of Bath, UK, he returned to Shanghai Jiaotong University. Currently he is a professor with the Dept. of Electrical Engineering at Shanghai Jiaotong University. His research interests include power quality, load modeling, smart grid, microgrid and intelligent algorithms.