



Thermal Performance Evaluation of Junction Thermal Bridge according to Installation Position of Window

Lee, Soo-Man* · Kim, Dong-Yun** · Ahn, Jung-Hyuk*** · Eom, Jae-Yong**** · Shin, U-Cheul*****

* Dept. of Architectural Engineering, graduate school, Daejeon Univ., South Korea (dltnaks5360@naver.com)

** Coauthor, Dept. of Architectural Engineering, graduate school, Daejeon Univ., South Korea (qwerk18@naver.com)

*** Coauthor, Eagon Windows & Doors Co. Ltd, South Korea (jhan@eagon.com)

**** Coauthor, Eagon Windows & Doors Co. Ltd, South Korea (jyum@eagon.com)

***** Corresponding author, Dept. of Architectural Engineering, Daejeon Univ., South Korea (shinuc@dju.ac.kr)

ABSTRACT

Purpose: “Building energy design standard” is used to limit the thermal transmittance of building in Korea. However, it only covers the insulation standard for each appropriate elements of a building, not the thermal performance of Junction thermal bridge of windows and doors installed in wall. Therefore in this study, we have evaluated the thermal performance of Junction thermal bridge depending on installation method and position of windows and provide it as design data. **Method:** We analyzed heat transfer of 4-Track sliding window and tilt & turn triple glazed window that are placed in the first class category on window energy efficiency rating using Window 7.4 and Therm 7.4. **Result :** First, linear thermal transmittance of 4-Track sliding window differs by 2.2 times or more depending of installation method and location. It is higher than the linear thermal transmittance, 0.01W/mK, proposed by Passivhaus. Second, linear thermal transmittance of Tilt & turn triple glazed window differs by 7.7 times or more depending of installation method and location. The average linear thermal transmittance was less than 0.01W /mK when windows were installed on the internal wall insulation by the fixed hardware attachment method. Third, the thermal losses of a window caused by a junction thermal bridge are inversely proportional to the window area and converge gradually as the area increased

KEY WORD

창
열교
선형 열관류율

Window
Thermal bridge
Linear thermal transmittance

ACCEPTANCE INFO

Received Apr 5, 2017
Final revision received May 29, 2017
Accepted Jun 2, 2017

© 2017 KIEAE Journal

1. Introduction

In Korea, energy conservation design standards for buildings are used to define the thermal transmittance of the building site area, and in recent years, as part of the achievement of passive buildings in 2017 and zero energy buildings in 2025 corresponding to the first Green Building Basic Plan, it has been a tendency to strengthen insulation standard. However, only insulation standard for each part is limited, and thermal performance for junction thermal bridges such as windows and doors installed on the walls is not presented. In addition, even measurement test of thermal transmittance of windows and doors according to KS F 2278, and the simulation analysis according to ISO 10077 are assumed that the area facing the wall is insulation boundary condition and the thermal loss at junction part is not considered.

On the other hand, in SAP of the UK,¹⁾ and SIA 380/1 of Swiss²⁾ and DIN 4108 Beiblatt of Germany,³⁾ etc. in the energy rating process of residential buildings, the thermal loss of junction thermal bridges of the window is reflected as the linear thermal transmittance (Ψ), and Passivhaus⁴⁾ defines the value as 0.01 W /

mK or less.

Examining the previous research trends on the junction part of window, Francesca et al.⁵⁾ evaluated thermal performance of junction thermal bridge junctions due to window installation position and frame insulation for wood system windows installed on walls of external insulation of clay bricks in Italy as linear thermal transmittance, and proposed as “thermal loss rate” diagram converted to the thermal loss of the window. According to the design conditions, the range of linear thermal transmittance was 0.398 ~ 0.02W/ mK, and decreased 70-75% when changing the window position from the outside air side to the indoor side. In addition, Linera⁶⁾ evaluated thermal performance for a total of 27 junction thermal bridge with 3 types of wall and 9 types of window in Sweden as linear thermal transmittance. According to the construction method, the linear thermal transmittance was 0.038 ~ -0.033W / mK and insulation of the lower part of frame junctioned with the wall was proposed for the prevention of thermal bridge ($\Psi < 0$). It can be here seen that there is a large difference between the linear thermal transmittance according to the architectural law of two regions and it is expected that there will be also a difference in window junction thermal bridge in Korea.

Therefore, this paper evaluates the thermal performance of junction thermal bridges according to the installation method and

the installation position of domestic architectural law and provides them as design data.

2. Domestic window installation method

Domestic window installation can be classified into anchor bolt attachment method, fixed hardware attachment method, and mixed method.

Fig. 1 shows the construction method of supporting the window by using the anchor bolt after aligning the level of with the support of the scaffold support on the top of wall composition. After the support is removed, the mortar or urethane foam is filled. In general, installation interval of anchor-bolt should be within 60 cm when window width is less than 1.5 m, 50 cm apart when it is 1.5m or more.

Fig. 2 shows attachment method supporting all the load of the window from the other side after fixing one side of “ \cap ” type fixed hardware (or bracket) to the composition body and all the frames are exposed to the insulation. Thermal loss is reduced by inserting a rubber pad on the mounting surface of the bracket, and when the length of one side of the window is less than 1.2m, the installation interval should be fixed 150mm away from both ends, and when it is 1.2m or more, it should be additionally installed at 500mm intervals.

Fig. 3 shows a mixed attachment method of anchor bolt and fixed hardware. It is used when the frame width is wide like a double window.



Fig. 1 Junction of window frame and wall by anchor-bolt



Fig. 2 Junction of window frame and wall by fixed hardware



Fig. 3 Junction by anchor-bolt and fixed hardware

3. Analytical model

3.1. Window for analysis

In this study, a 4-track sliding window and a tilt-turn system window with triple glazing with energy efficiency 1st grade were selected as window model for analysis. As of February 2017, energy efficiency 1st grade certification windows were a total of 850 and of these, double glazing were 727 (85%) and triple glazing 79 (9%).

Fig. 4 shows the PVC 4-track sliding window. It constitutes 2 sheets 22mm double glass with an interval of 100mm((5mm GN+12mm Ar+5mm CL) and (5mm CL+12mm Ar+5mm Double Low-E))

Fig. 5 shows a system window composed of 35mm triple glass (5mm Double Low-E+10mm Ar+5mm CL+10mm Ar+5mm Double Low-E). The thermal transmittance of the simulation by KS F 2278 standard THERM was interpreted as 0.945W/m²·K and 0.891W/m²·K, respectively.

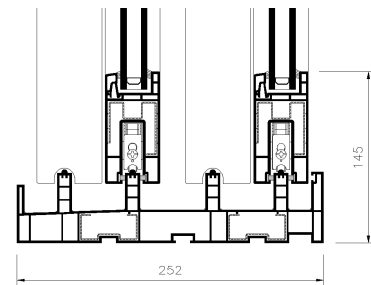

Fig. 4 4(Four)-Track sliding window

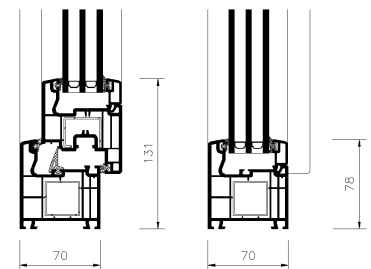

Fig. 5 Tilt & turn triple glazed window

Fig. 6 shows the frame composition of the 4-track sliding window for the simulation analysis. It consists of an upper head, a lower sil, a left and right jamb, and a meeting rail where two windows overlap.

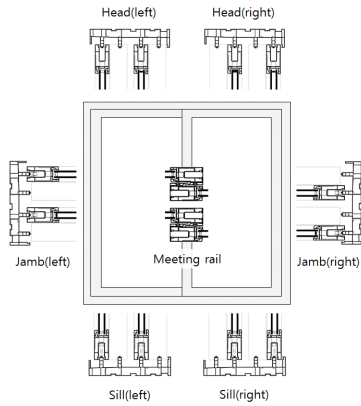

Fig. 6 Composition of 4-track sliding window

Fig. 7 shows the frame composition of the tilt & turn system window. It is divided into opened and closed window (Vent) and fixed window (Fix) and each window consists of head, sil, jamb, etc.

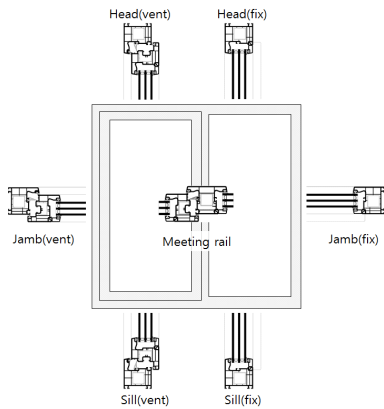

Fig. 7. Composition of tilt & turn triple glazed window

3.2. Installation location of wall and window for analysis

The enclosure where the window is installed is set as a wall facing directly to the outer atmosphere of the Chubu District according to the “Energy Saving Design Standard Of Building”, and is divided into internal insulation and external insulation. Table 1 shows the composition of walls.

Table 1. Wall composition

Item	External insulation	Internal insulation
Cross section		
Construction	4mm Stucco plex + 180mm 1 st Rating Insulation + 180mm Concrete + 10mm Plaster board	180mm Concrete + 180mm 1 st Rating Insulation + 10mm Plaster board
Thermal transmittance	0.21W/m ² ·K	

Table 2 shows the installation position of the 4-track sliding window. In case of internal insulation, the sliding window is divided into the case where the interior side frame of the window matches the interior finish surface (case 1) and the case where the center line of the window matches the junction surface of the composition body and the insulation (case 2), and in case of internal insulation, it is placed in the opposite direction. Here, Urethane foam was filled between the frame supported by the anchor bolt and the composition body. All cases are mixed attachment method installation type that a part of the frame faces the insulation.

As shown in Table 3, they were divided into the anchor bolt attachment method (case 3) which fixed to the upper part of the system window composition body, and the fixed hardware attaching method (case 4) that all sides of the frame faced with insulation.

Table 2. Installation position of 4-track sliding window

Item	External insulation		Internal insulation	
	Left	Right	Left	Right
Case 1				
Case 2				

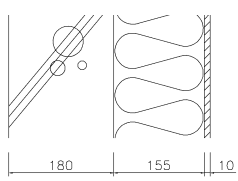
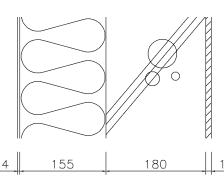
Table 3. Installation position of tilt & turn triple glazed window

Item	External insulation		Internal insulation	
	Vent	Fix	Vent	Fix
Case 3				
Case 4				

4. Thermal performance analysis of window junction part

4.1. Analysis program

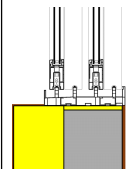
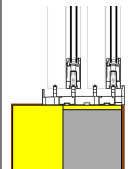
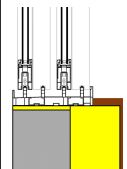
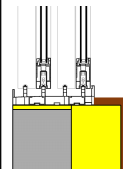
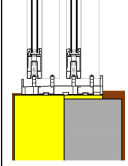
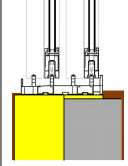
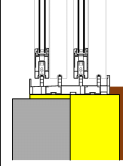
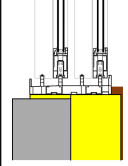
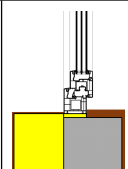
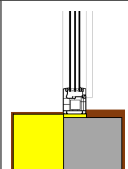
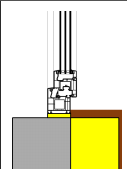
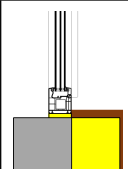
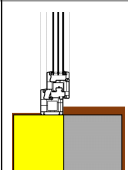
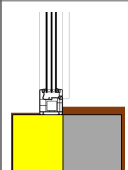
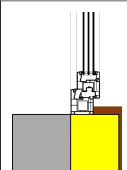
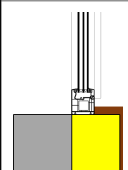
The heat transfer analysis program used in this study was Window 7.4 and Therm 7.4. The indoor and outdoor boundary conditions for the simulation were applied to the domestic KS F 2278 standard. Table 4 shows the thermal properties of materials.

Table 4. Thermal properties of materials

Material	Conductivity (W/mK)	Emissivity
PVC	0.14	-
Aluminum	160	0.9
Stainless	17	0.8
EPDM	0.25	-
Polyamide	0.3	-
Silicone	0.35	-
Silica Gel	0.13	-
Insulation(EPS)	0.035	-
Urethane foam	0.024	-
Concrete	1.6	-
Plaster board	0.18	-
Stucco plex	0.04	-
MDF	0.14	-

4.2. Linear thermal transmittance

The thermal loss of window junction thermal bridge is evaluated by linear thermal transmittance, and equation (1) represents the linear thermal transmittance Ψ according to ISO 102117.

$$\Psi = L^{2D} - \sum_{j=1}^N U_j l_j \quad (1)$$

Here,

L^{2D} : The thermal conductivity coefficient (W/m·K) calculated by two-dimensional calculation

U_j : Thermal transmittance of component j (W / m² · K)

l_j : Length corresponding to U_j (m)

4.3. Thermal loss according to fixed hardware

In fixed hardware or mixed attachment method, the heat transfer of bracket junction part is different from that of the non-installed part. Table 5 compares the heat transfer of the bracket and frame sill junction part in the external insulation wall with non-junction parts. In the case of sliding window installed in mixed support method (case 1), the linear thermal transmittance at the bracket installation part was 0.136 W / mK, which was 4.8 times higher than 0.028 W /mK at the non-installation part.

Also, in the system window installed with the fixed hardware support method (case 3), the heat loss at this part was analyzed to be 4.5 times higher than the non-installed part. Therefore, in this study, The thermal losses of the bracket installation and non-installed part were averaged by area when calculating the linear thermal transmittance of a junction part.

Table 5. Heat transfer of fixed hardware joint

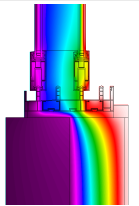
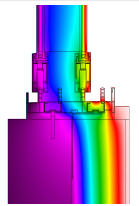
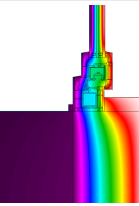
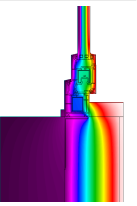
4-Track sliding window		Tilt & turn triple glazed window	
Sill	Sill(+Bracket)	Sill	Sill(+Bracket)
			
0.028W/m·K	0.136W/m·K	0.001W/m·K	0.045W/m·K

4.4. Linear thermal transmittance of window junction thermal bridge

Table 6 shows the linear thermal transmittance for junction part heat loss of a 4-track sliding window of 2m (width)×2m (height), and the difference is 2.2 times or more depending on the installation position. Here, the installation position of the left and right windows is changed according to the track, and the linear thermal transmittance is changed. In the case of the frame facing the inner and outer finishing surfaces of composition body (case 1), comparing the thermal loss according to the insulation construction method, the linear thermal transmittance increases by part by more than 27% to 52% in internal insulation compared to external insulation.

When the center line of the window as installation position matches the junction face of the composition body and the insulation (case 2), the linear thermal transmittance by part is reduced by 28 ~ 49% and the heat loss is greatly improved. However, it is still higher than the linear thermal transmittance, 0.01 W/mK proposed by Passivhaus.

Table 6. Linear thermal transmittance of Junction Thermal Bridge on 4-Track sliding window (U_{int} : W/m·K)

Item		Sill		Jamb		Head	
		Left	Right	Left	Right	Left	Right
Case 1	External	0.045	0.101	0.051	0.105	0.046	0.100
	Internal	0.071	0.022	0.077	0.027	0.071	0.022
Case 2	External	0.023	0.062	0.032	0.076	0.024	0.062
	Internal	0.046	0.013	0.064	0.017	0.047	0.013

Table 7 shows what compares the linear thermal transmittance by junction part of 2m(width)×2m(height) system windows. Depending on the installation method and the installation position, the mean linear thermal transmittance of junction part shows a difference of 7.7 times or more. When anchor-bolt is supported on the composition body (case 3), the linear thermal transmittance is almost the same as the “case1” of the sliding window, and the

external insulation is somewhat lower in the insulation method. In the case of fixed hardware attachment (case 4), thermal performance is greatly improved by linear thermal transmittance close to passive house standard, particularly, it was analyzed that thermal loss of junction part hardly occurs at internal insulation.

Table 7. Linear thermal transmittance of Junction Thermal Bridge on tilt & turn triple glazed window (Unit: W/m²K)

Item		Sill		Jamb		Head	
		Vent	Fix	Vent	Fix	Vent	Fix
Case 3	External	0.054	0.051	0.083	0.080	0.054	0.051
	Internal	0.064	0.065	0.065	0.067	0.064	0.065
Case 4	External	0.017	0.018	0.024	0.027	0.017	0.018
	Internal	0.005	0.007	0.009	0.013	0.006	0.008

4.5. Window overall thermal transmittance & thermal loss rate

The window thermal performance containing junction part can be defined as the total overall thermal transmittance of equation (2)

and can be estimated as the thermal loss rate 5) of equation (3) compared with thermal transmittance of a existing window.

$$U_{2D} = \frac{U_w A_w + \Psi_{sill} W + \Psi_{jamb} 2H + \Psi_{head} W}{A_w} \quad (2)$$

$$\Delta U_w = \frac{U_{2D} - U_w}{U_w} \times 100 \quad (3)$$

Here,

U_{2D} : window overall thermal transmittance including heat loss of junction part.(W/m²K)

U_w : Window thermal transmittance (W/m²K)

ΔU_w : Thermal loss rate (%) due to junction part

A_w : Window area (m²)

W : Window width (m)

H : Window height (m)

Ψ : Linear thermal transmittance by junction part(W/mK)

Table 8. Thermal loss rate of 4-track sliding window by junction method

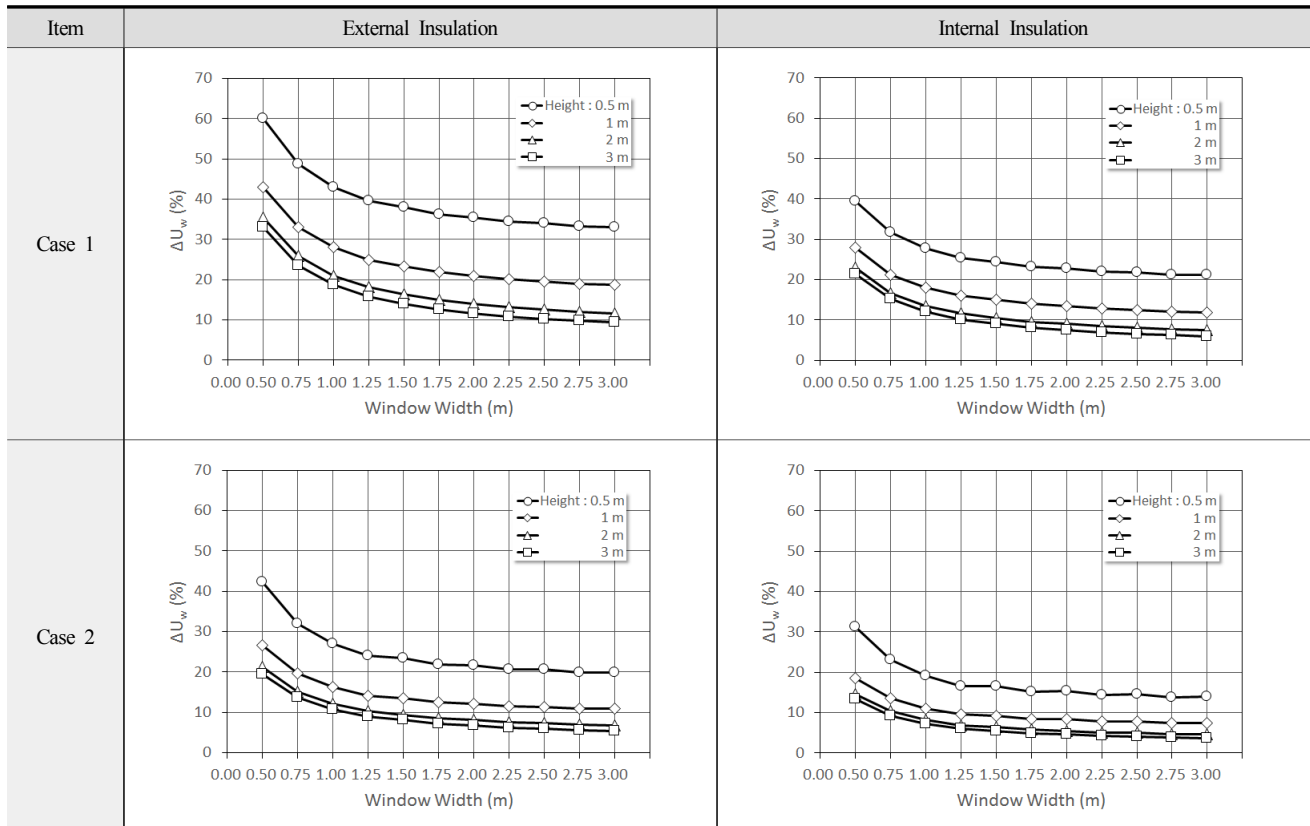

Table 9. Thermal loss rate of 4-track sliding window by junction method

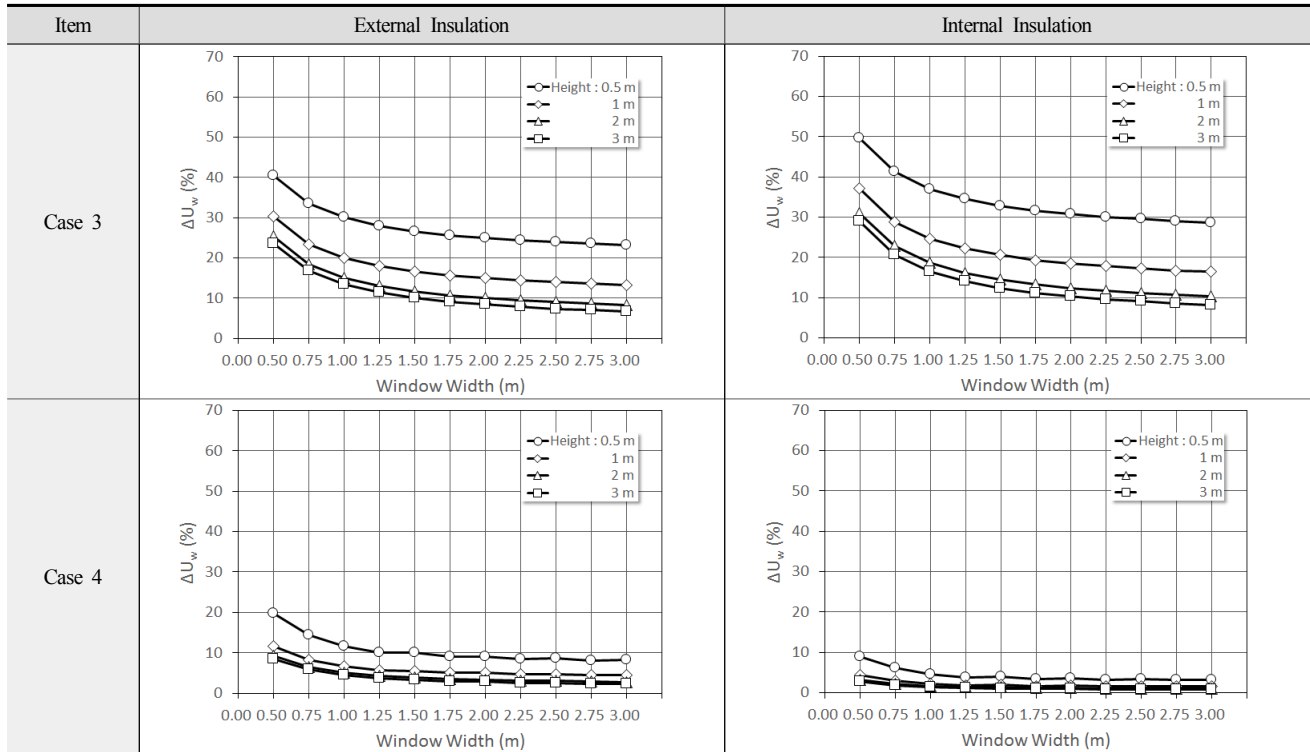

Table 8 shows what compares thermal loss rate according to the installation position and insulation method of the 4-track sliding window according to window size. The thermal loss rate was inversely proportional to the window area, but it gradually converges as the area increases. Also, the frame area facing the insulation is large (Case 2), and the thermal loss rate is reduced when the insulation is internal.

Table 9 shows what compares the thermal loss rate of the triple glazed window according to the window size. It can be seen that the thermal loss rate of the system window with relatively narrow frame width compared with the sliding window is greatly different according to the installation position of the installation position. When the fixed hardware attachment method (Case 4) in which the frame faces all the insulation, the thermal loss rate is less than 10% when the window width is more than 1m, and in the case of internal insulation, it is further reduced to less than 5%.

Table 10 shows what compares the overall thermal transmittance and thermal loss rate of 4-track sliding window with 2m(width) × 2m(height) size and triple glazed window. For a 4-track sliding window with the same performance, depending on the installation method, an additional thermal loss of 6.4 ~ 15.8% is expected, and in the triple glazed window, it is somewhat lower, but there is still a big difference (1.6 ~ 13.2%). As a result, it can be assumed that even in the case of the first grade window, the actual thermal performance may fall into the second grade window.

Table 10. Overall thermal transmittance & thermal lose rate

Item	4-Track sliding window				Triple glazed window				Area/ Length
	Case 1		Case 2		Case 3		Case 4		
	Int.	Ext.	Int.	Ext.	Int.	Ext.	Int.	Ext.	
U_w	0.945	0.945	0.945	0.945	0.891	0.891	0.891	0.891	4m ²
Ψ_w	0.075	0.048	0.047	0.033	0.062	0.065	0.020	0.008	8m
U_{2b}	1.094	1.042	1.038	1.012	1.069	1.075	0.985	0.961	-
ΔU_w	15.8	8.8	8.9	6.4	13.2	12.2	3.8	1.6	-

5. Conclusion

In this study, to evaluate the thermal performance of the junction thermal bridge according to the installation method and the installation position of window in the wall, 4-track sliding window and triple glazing system of energy efficiency grade 1 standard were selected as the analytical model and the heat transfer was analyzed using Window 7.4 and Therm 7.4. The results are summarized as follows.

First, in the case of the 4-track sliding window, the linear thermal transmittance was 2.2 times or more different according to the installation method and installation position, which is higher than the linear thermal transmittance proposed by Passivhaus 0.01 W / mK.

Second, in case of system windows, the linear thermal transmittance of junction part was found to be more than 7.7 times depending on the installation method and installation position, and the average linear thermal transmittance was less than 0.01 W / mK

when installed in the fixed insulation attachment method.

Third, the thermal loss rate of the window according to thermal bridges was inversely proportional to the window area, but as the area increases, it gradually converges. In case of 4-track sliding window, the area of the frame facing the insulation is wide, and the thermal loss rate has decreased in the wall.

Fourth, in case of system window with narrow frame width compared with sliding window, the thermal loss rate according to the installation position was changed to a larger width, and fixed hardware attachment method in which the frame faces the insulation in the wall was less than 5%.

As shown in this study, the linear thermal transmittance of the same window shows a large difference depending on the installation location or installation method of junction part. Therefore, this point should be reflected in building window design phase and building energy simulation analysis.

Acknowledgements

This research was supported by New industry creation project business of New Industry Promotion Agency research of the Ministry of Science, ICT and Future Planning and Commercializations Promotion Agency for R&D Outcomes [2016-K000249]

Reference

- [1] The Government's Standard Assessment Procedure for Energy Rating of Dwellings 2016 edition
- [2] Energie schweiz, Wärmebrückenatolog, SIA380/1
- [3] DIN 4108 Beiblatt 2
- [4] Passivhaus Institut, Criteria and Algorithms for Certified Passive House Components: Opaque construction systems, 2015
- [5] Francesca Cappelletti, Andrea Gasparella, Piercarlo Romagnoni, Paolo Baggio, "Analysis of the influence of installation thermal bridges on windows performance: The case of clay block walls", Energy and Buildings, 2011.02
- [6] Cristina Garcia Linera, Energy Efficient Window, Master's Thesis, Chalmers University of Technology, 2011
- [7] ISO 10211-2:2001 Thermal bridges in building construction - Calculation of heat flows and surface temperatures - Part 2: Linear Thermal bridges