

## Overlapped Electromagnetic Coilgun for Low Speed Projectiles

Hany M. Mohamed<sup>1</sup>, Mahmoud A. Abdalla<sup>2\*</sup>, Abdelazez Mitkees, and Waheed Sabery

*Electrical Engineering Branch, MTC College, Cairo, Egypt*

<sup>1</sup>*Hany.M.EG@ieee.org*

<sup>2</sup>*Maaabdalla@ieee.org*

(Received 20 February 2015, Received in final form 16 June 2015, Accepted 16 June 2015)

This paper presents a new overlapped coilgun configuration to launch medium weight projectiles. The proposed configuration consists of a two-stage coilgun with overlapped coil covers with spacing between them. The theoretical operation of a multi-stage coilgun is introduced, and a transient simulation was conducted for projectile motion through the launcher by using a commercial transient finite element software, ANSOFT MAXWELL. The excitation circuit design for each coilgun is reported, and the results indicate that the overlapped configuration increased the exit velocity relative to a non-overlapped configuration. Different configurations in terms of the optimum length and switching time were attempted for the proposed structure, and all of these cases exhibited an increase in the exit velocity. The exit velocity tends to increase by 27.2% relative to that of a non-overlapped coilgun of the same length.

**Keywords :** electromagnetic launch, excitation circuit, lorentz force, overlapped coilgun

### 1. Introduction

Electromagnetic (EM) launch technology is a strong candidate to launch objects with high velocities over long distances. A coilgun launcher is a specific application for an electromagnetic launch that uses a moderate power excitation circuit [1]. A coilgun consists of discrete solenoidal coils that are connected end-to-end and are wound around a hollow dielectric tube. A projectile inside this tube moves due to the presence of coupling between the coils and the armature. Capacitor bank circuits are connected to the coils that are triggered sequentially to deliver current pulses into the coil's stages, and as the current pulse travels through the coil's winding, the interaction between the magnetic field and the induced current within the armature (projectile) generates an axial force that moves the projectile along the barrel. A number of parameters affect the performance and efficiency of the coilgun including: the muzzle velocity, projectile peak and average acceleration [2]. Although the working principle of a coil gun is simple, the launch of a coil gun is a complex electromagnetic transient process, and so it

is not easy to obtain the main performance parameters and optimize the design [3].

Sandia National Laboratories has succeeded in coilgun design and operations by developing four guns with projectiles ranging from 10 g to 5 kg and speeds of up to 1 km/s, validating the computational codes and basis for gun system control. In addition, coilguns use magnetic coupling to drive the current in the armature without requiring direct electrical contact between the barrel and the projectile. This results in a long barrel lifetime that will be useful for next-generation long-range artillery guns for land-based and naval platforms [4].

A coilgun launcher can be designed as a multi-stage structure. This kind of launcher can be referred to as a synchronous induction coilgun (SICG) or also a coaxial coil launcher. It consists of a sequence of powered multi-turn drive coils that surround a barrel with a circular cross section through which a conducting armature passes [5]. The drive coils must be separately energized by the external source, which is controlled by switches that are triggered to sequentially deliver current pulses into the coil stages. The time to turn the switches on and off must be governed by the position of the armature [6].

This type of launcher has several advantages that result in a higher acceleration, including no drop in acceleration as the mass of the projectile increases, a higher peak

---

©The Korean Magnetism Society. All rights reserved.

\*Corresponding author: Tel: +2-01118750114

Fax: +2-01118750114, e-mail: maaabdalla@ieee.org

pressure on the projectile and smaller differences between the average and peak pressure. The analytical approach for an inductive coilgun is relatively complex due to the time-varying mutual inductances between the driver coils and the projectile in the transient launch process. Hence, it is necessary to rely on finite element software or a numerical approach to design a coilgun that can achieve good launch characteristics [7].

In this paper we introduce a new configuration for a multi-stage coilgun that is based on an overlap between two cascaded coilgun stages. This configuration is proposed in order to achieve a higher launch velocity for a projectile with the same coilgun length. The theoretical concepts of the proposed overlapped structure are introduced, and the performance of the new configuration is examined and compared to that of a conventional (non-overlapped) coilgun. An extensive study was carried out to validate the results, and the simulation of the projectile movement through the coilgun is carried out by using the finite element method.

## 2. Theory

### 2.1. Basic Coilgun Concept

The electromagnetic coil launcher structure is shown in Fig. 1, and as is shown in the figure, it consists of stator coil and an armature that moves along the stator coil axis. As shown in the figure, the armature is the projectile itself, and the stator current density ( $J_s$ ) circulates around the axis. This current induces a magnetic field inside the armature ( $B_a$ ), and accordingly, a current density ( $J_a$ ) is induced in the armature that results in turn in a magnetic field around the stator ( $B_s$ ). The force that affects the projectile inside of the electromagnetic coil is shown in Fig. 1, and the driving force ( $F$ ) in the coil launcher is the Lorentz Force [8, 9]. The force ( $F$ ) can be decomposed into a propulsive (axial) force ( $F_z$ ) and a radial force ( $F_r$ ) that exist on both the armature and the stator.

The radial forces of the coilgun that are induced on the both stator and the armature are in opposite directions. These opposing radial forces center the armature inside the stator coil, making a contactless launch possible. Hence, the projectile is centered and no friction occurs between the projectile and the stator walls, and thus, the radial forces are balanced. Accordingly, the motion of the projectile inside of the stator is mainly a result of the armature axial force that affects the projectile. This force can be mathematically expressed as

$$F_{az} = J_{a\phi} \times -B_{sr} \quad (1)$$

where ( $F_{az}$ ) is the armature axial force that pushes the

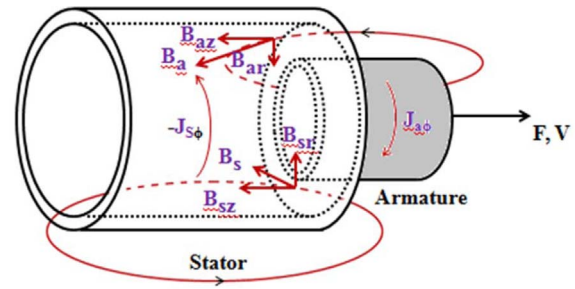

**Fig. 1.** (Color online) Forces that exist on the stator and armature coaxial coils for a single stage coilgun.

projectile, ( $J_{a\phi}$ ) is the radial armature current density and ( $B_{sr}$ ) is the stator radial magnetic field. Hence, the speed inside of the projectile resulting from this force can be calculated as [6]

$$m_a \frac{dv_a}{dt} = I_a I_s \frac{dM_{as}}{dz} \quad (2)$$

$$v_a = \frac{dz}{dt} \quad (3)$$

where ( $m_a$ ) is the mass of the armature, ( $v_a$ ) is the velocity of the armature, and ( $I_a, I_s$ ) are the induced armature and stator coil currents, respectively. ( $z$ ) is the displacement of the armature and ( $M_{as}$ ) is the mutual inductance between the armature and the stator coil [6].

### 2.2. Multi stage Coil Gun

In the case of the multi stage coilgun, the analysis can be carried using the Current Filament Method (CFM), as shown in Fig. 2. The projectile and conductive parts of the coil are divided into elementary elements ( $m$  and  $n$ ) within which the projectile can be assumed to be a point projectile. Hence, the current distribution is uniform. Next, a numerical field computation is used to calculate the value of the forces that are applied on the projectile by determining the flux distribution, magnetic field and velocity that act on the projectile anywhere inside of the system for each small section. Finally, the current filament associated with each volume element and its corresponding electrical parameters are calculated.

The velocity of the projectile can be calculated using Eq. (3), where the force exerted on the projectile can be calculated as [10]

$$m_a \frac{dv_a}{dt} = \sum_{i=1}^m I_{ai} I_{si} \frac{dM_{asi}}{dz} \quad (4)$$

where

$I_{ai}$  : Armature current for the  $i^{\text{th}}$  element point projectile.

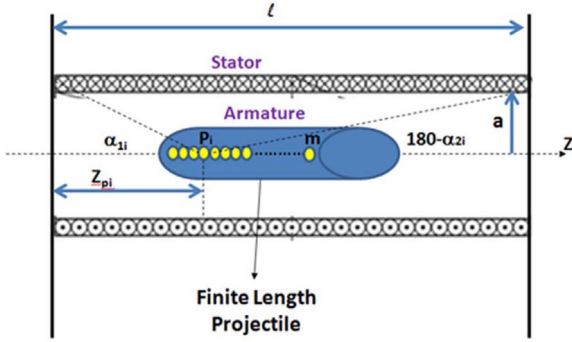

**Fig. 2.** (Color online) Schematic diagram of the CFM of a coilgun.

- $I_{si}$  : Stator current for the  $i^{th}$  element point projectile.
- $Z_{pi}$  : position along the  $z$  axis of the  $i^{th}$  element point projectile.
- $M_{asi}$  : Mutual inductance between the  $i^{th}$  element point projectile and the coil (stator).

The knowledge of the magnetic field at an arbitrary place ( $Z_{pi}$ ) allows for a simplified form of the mutual inductance to be written as

$$M_{asi} = \frac{N^2 \mu A}{2l} \left[ \frac{Z_{pi}}{\sqrt{a^2 + Z_{pi}^2}} - \frac{(Z_{pi} - l)}{\sqrt{a^2 + (l - Z_{pi})^2}} \right] \quad (5)$$

From the velocity definition for the finite length projectile, a numerical code should be used to solve the projectile velocity, flux linkage and mutual inductances. The transient finite element method is used, and the ANSYS MAXWELL commercial software is employed during this simulation.

In our work, mutual coupling can be further improved with two overlapping stages. This introduces a higher degree of freedom in the designing of a multi-stage coilgun that can achieve a higher exit velocity, as will be explained in the following section.

### 3. Structure and Results

#### 3.1. Structure

As previously mentioned, the structure proposed in our work is that of an overlapped coilgun. This structure was investigated and is compared to a conventional multi stage coilgun. Design started by optimizing the single-stage coilgun length and the number of turns [11]. The detailed parameters of the optimization are explained in Ref. [12] as follows:

1. The initial position of the projectile is a very important parameter to know because it can affect the velocity of the projectile during its path along the barrel until the

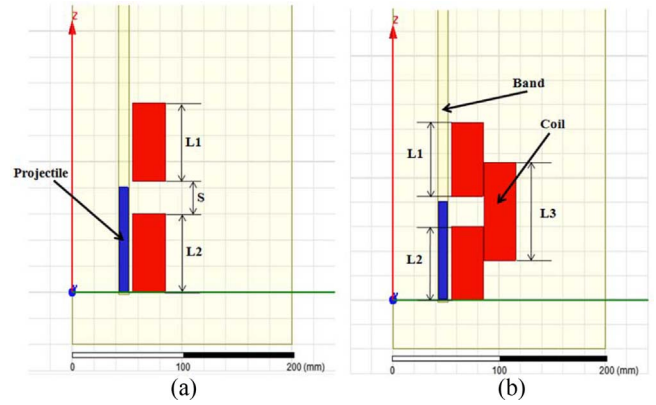

**Fig. 3.** (Color online) Coilgun layout (a) two-stage coilgun. (b) two-stage overlapped coilgun.

muzzle point. Therefore, we have to select the best position to launch the projectile in order to obtain the highest muzzle velocity.

2. Studying the effect of the flux linkage between the coil and armature to ensure the best muzzle velocity of the projectile.
3. An inversely proportional relationship is observed between the length of the coil and the muzzle velocity of the projectile, so the coil length needs to be optimized to obtain a better muzzle velocity.
4. The effect of the number of turns of the coil, applied voltage and current pulse must be investigated and optimized in order to achieve the desired muzzle velocity.
5. Finally, the material of the projectile has a big effect on its velocity. Accordingly, it is necessary to choose the best material to ensure a suitable muzzle velocity.

In our work, two models were designed, and their performance is evaluated by using using the ANSOFT MAXWELL transient finite element commercial software.

The first model consists of a two-stage coilgun with each coil of length “L1” and “L2” with spacing “S” between them, as shown in Fig. 3(a). The second model is a two-stage overlapped coilgun where the spacing between the two stages is covered by the overlapped coil with length “L3,” as shown in Fig. 3(b). Each coil has its own number of turns, and the end of the projectile is placed at the zero “Z” axis as the initial position. It is worth commenting that the starting position of the projectile has passed many optimizations, and the projectile is a hollow aluminum cylinder with an inner radius of 43 mm, outer radius of 51 mm and weight of 0.51 Kg. A band was added in the simulation to give the projectile the opportunity to move along the path desired inside the barrel until leaving it.

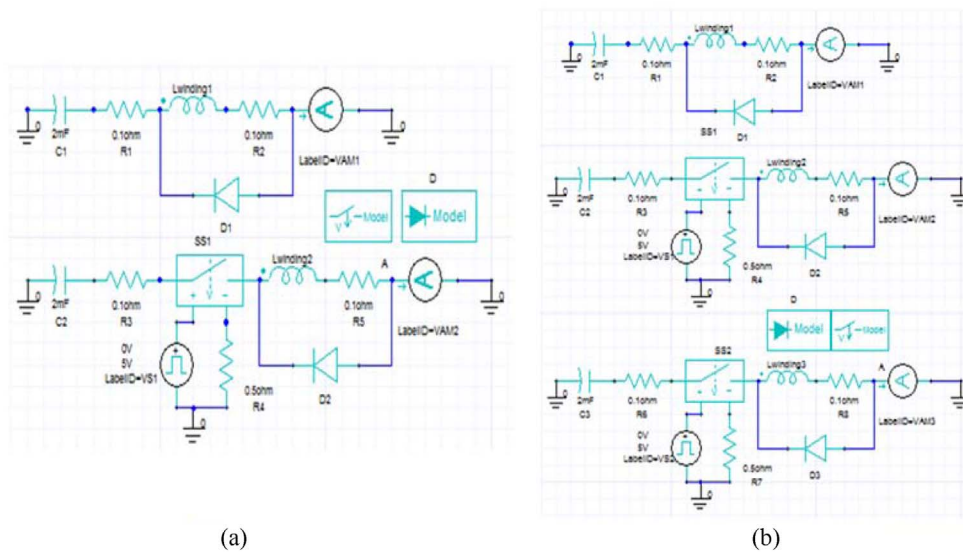

**Fig. 4.** (Color online) (a) Excitation circuit for the two-stage coilgun. (b) excitation circuit for the two-stage overlapped coilgun.

### 3.2. Excitation circuit

In this section, we present the excitation circuit that delivers sufficient current to produce the required magnetic field to push the armature forward. The excitation circuit was designed as a moderate power circuit and is used in our work to provide a discharging pulse. The initial energy is stored in a capacitor bank with an equivalent value of 2 mF. The circuit editor of the ANSOFT MAXWELL commercial software is used to validate the design.

As shown in Fig. 4 the excitation circuit was implemented during the discharge phase as the initial stored voltage in the capacitor bank was 5000 V. A freewheeling diode is connected across each winding to prevent the discharged pulse from oscillating and to ensure its smooth decay with time. A pulsed switch was also added to provide precise timing for the switch after the projectile leaves the first coil stage. The naming of the windings in the circuit editor must be the same in the finite element simulator to be synchronized with each other while importing it from another circuit editor. As shown in Fig. 4(a), winding 1 is named to be synchronized with the first coil while winding 2 is named to be synchronized with the second coil in the finite element simulator. As shown in Fig. 4(b), the naming is the same for the windings as in Fig. 4(a), except with the addition of winding 3 that is to be synchronized with the overlapped coil that is added over spacing between the two coils, as previously mentioned in Fig. 3(b).

### 3.3. Results

In the results section, we investigate how the overlapped section can improve the performance of the coilgun

relative to the non-overlapped one. This is carried out in two steps, the first one involves investigating the effect of the coil spacing and the second one consists of changing the used coil length itself.

#### 3.3.1. Effect of Spacing:

The effect of the spacing “S”, and hence the overlap length “L3”, is the main cause for coupling between the two stages of the coilgun. Hence, the exit velocity of the muzzle is simulated for ten different possible cases of S. The two aligned coils are kept constant with a length of 60 mm and 120 turns. Accordingly, the length (L3) of the overlapped coil and its number of turns varies in each case. The results are thus recorded with spacing between the two stages that starts from 5 mm to 50 mm with 5 mm steps in each case. We will choose only two of these to be further discussed in the details, and we finally represent the data figure that shows all of the results in a comparison between the two-stage coilgun and the two-stage overlapped coilgun.

In the first chosen case, the spacing (S) is detected as 25 mm between the first and second coil while the second case spacing (S) is detected as 40 mm between the first and second coil. For the first focused case, the non overlapped configuration is shown in Fig. 5(a). After 1 ms, the second stage is excited by its own supply circuit that supports the magnetic field of first coil in order to increase the velocity of the projectile, resulting in an exit velocity that reaches 142.6 m/s after 3.1 ms from discharge. On the other hand, the overlapped configuration in Fig. 5(b) has a length of 80 mm for the overlapped coil (L3), where it covers two cascaded coils by 27.5 mm up

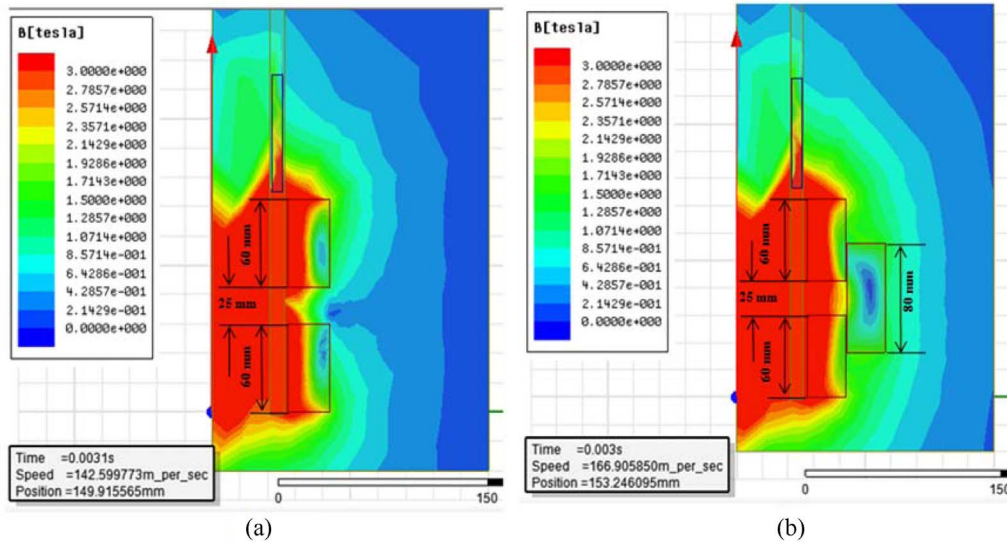

**Fig. 5.** (Color online) (a) Two-stage coilgun with 25 mm spacing between the cascaded coils. (b) two-stage overlapped coilgun with 80 mm of overlapped coil covering the spacing between the cascaded coils.

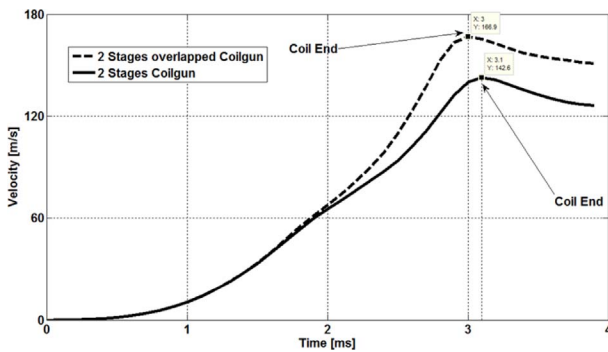

**Fig. 6.** (Color online) Velocity profile results for the two-stage coilgun and two-stage overlapped coilgun with 25 mm spacing between the cascaded coils.

and down. This overlapped coil has its own supply circuit that is excited after 1 ms to support a projectile until reaching the second coil, which is excited after 1.5 ms. In this case, the projectile is recorded to reach the end of barrel after 3 ms with an exit velocity nearly equal to 167 m/s. Thus, there is a 17.1% increase in velocity in the case with the overlapped coilgun relative to the cascaded two-stage coilgun. To explain this improvement in the exit muzzle velocity, the projectile velocity profile in the two cases is simulated, as shown in Fig. 6. In the first two milliseconds, the behavior of the two models remains the same until the effect of the overlapped coil appears, which makes a difference in the velocity.

The second case of the geometry that was chosen for focus is shown in Fig. 7(a) for the non overlapped configuration and in Fig. 7(b) for the overlapped configura-

tion. The length of the overlapped coil (L3) remains 80 mm, as shown in Fig. 7(b). In this case, the dimensions are the same for the length, width and number of turns for the three coils, except that the spacing between the two aligned stages is raising to 40 mm. After 1.8 ms, the second stage is excited to increase the velocity of the projectile, which leaves the first stage completely with a velocity of 97.6 m/s after 2.2 ms, resulting in an exit velocity that reaches 132.1 m/s after 3.1 ms from discharge. On the other side, the velocity that is recorded for the projectile after 3.2 ms was of 163.1 m/s in an overlapped configuration which is a 23.46% increase in the velocity when compared to the cascaded two-stage coilgun, as shown in Fig. 8.

The projectile velocity for the two-stage coilgun and the two-stage overlapped coilgun versus the spacing is shown in Fig. 9, where the spacing varies from 5 mm to 50 mm. The results of the figure confirm that the overlapped configuration has a better response than the conventional one. It is obvious that the spacing between the two cascaded stages is essential to increase the velocity. The best result is thus achieved for a separation of 35 mm where the exit velocity increases from 124.2 m/s to 158 m/s (27.2%).

Table 1 summarizes the ten cases that have been studied, showing the spacing, length and exit velocity of each overlapped case. Finally, we can say that the overlapped case can achieve a better exit velocity relative to the non-overlapped coilgun.

The effect of the overlapped length is also discussed for the 40 mm spacing between the aligned stages (as the

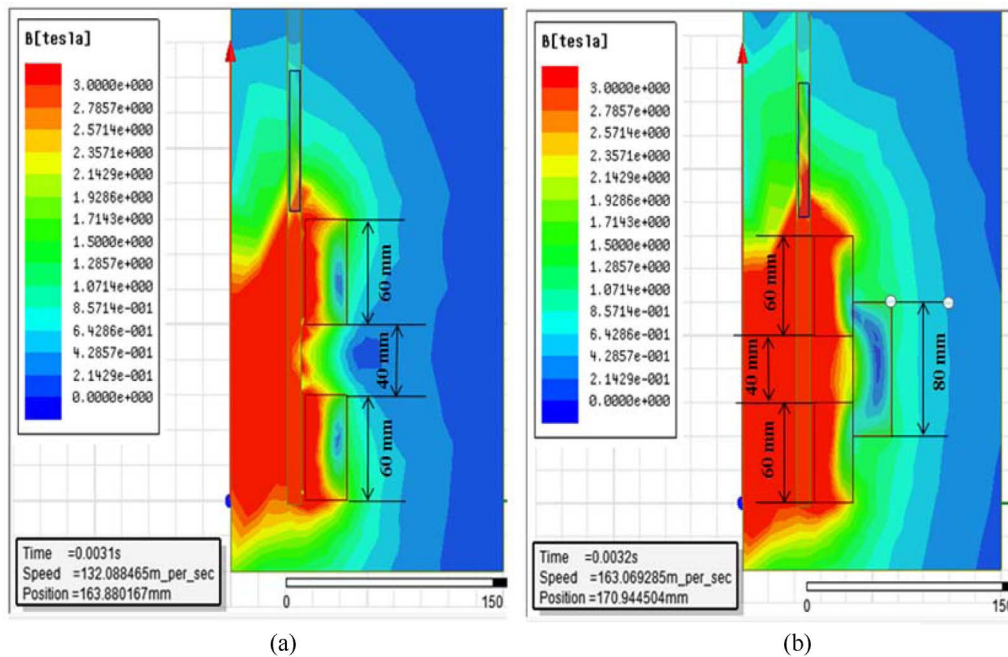

Fig. 7. (Color online) (a) Two-stage coilgun with 40 mm spacing between the cascaded coils, (b) two-stage overlapped coilgun with 80 mm of overlapped coil covering the spacing between the cascaded coils.

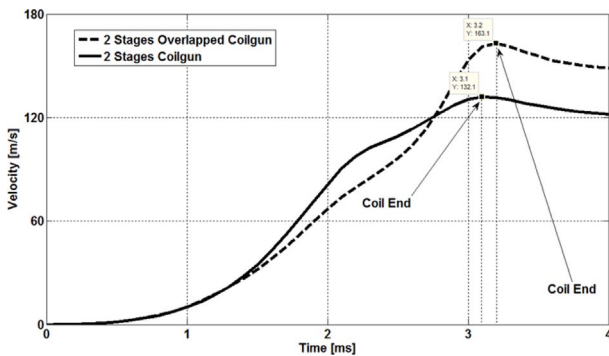

Fig. 8. (Color online) Velocity profile results for the two-stage coilgun and two-stage overlapped coilgun with 40 mm spacing between the cascaded coils.

Table 1. Results for the ten cases studied for the overlapped coilgun.

Spacing (mm)	Overlapped coil length (mm)	Exit velocity (m/s)
5	20	160.8
10	20	158
15	20	158.9
20	60	147.3
25	80	166.9
30	60	151.4
35	60	158
40	80	163.1
45	80	158
50	60	150.3

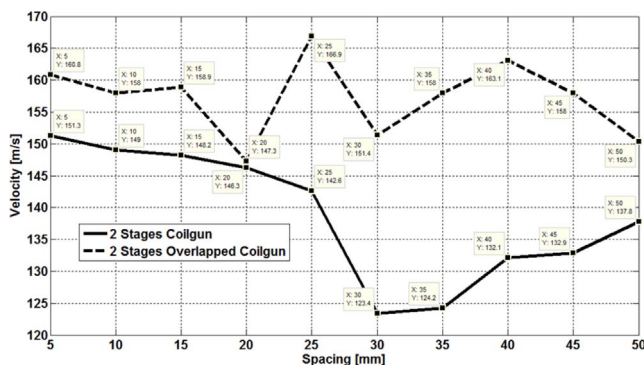
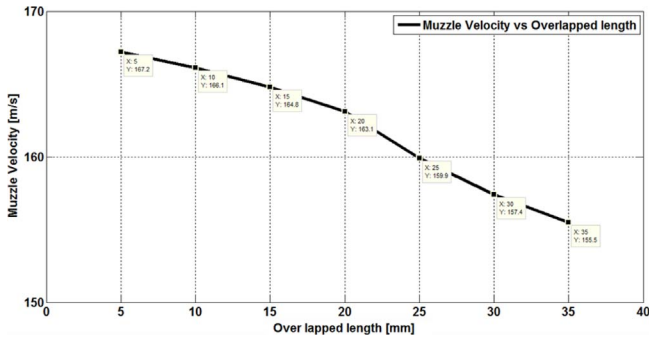

Fig. 9. (Color online) Velocity comparison between the two-stage coilgun and two-stage overlapped coilgun.

optimum spacing between the two aligned coils) and a number of results were recorded for different values of the overlapped, length starting from 5 mm to 35 mm with a 5 mm increment in each of the recorded results. The detailed results are shown in Fig. 10, where the muzzle velocity decreases from 167.2 m/sec to 155.5 m/sec as the overlapped length increases.

To illustrate our idea of the effect of the overlapped coil through our work, the two cases that were studied are re-plotted within the position to determine the position for which the overlapped length takes place. For the first chosen case, which is shown in Fig. 11, the two models had the same velocity profile for the first 40 mm of the



**Fig. 10.** (Color online) Muzzle velocity of the projectile vs the overlapped length covering the cascaded coils.

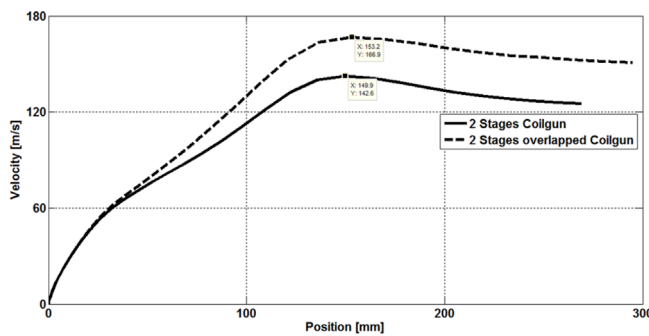

**Fig. 11.** (Color online) Velocity results for the two-stage coilgun and two-stage overlapped coilgun with 25 mm spacing between the cascaded coils.

total journey of the projectile, but after 1 ms, overlapped stage is excited by its own supply circuit supporting the magnetic field of first coil thereby increasing the velocity of the projectile for overlapped case. The curve of the velocity begins to move up, and it moves away from the velocity curve of the non-overlapped coilgun.

Similar to what was done for the first case, the second case (for  $S = 40$  mm) is re-plotted with the position, as

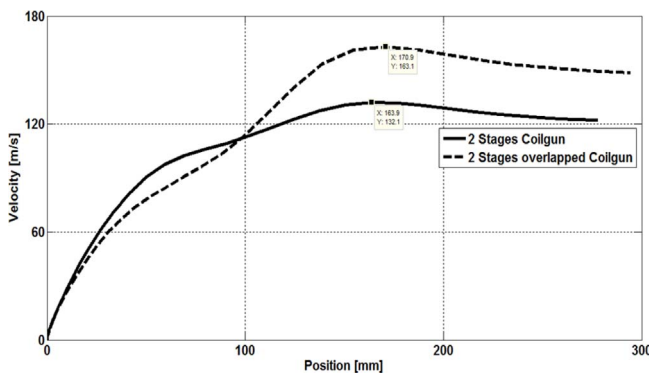

**Fig. 12.** (Color online) Velocity results for the two-stage coilgun and two-stage overlapped coilgun with 40 mm spacing between the cascaded coils.

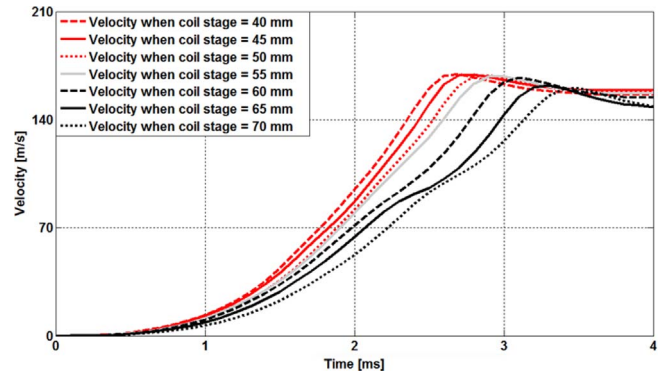

**Fig. 13.** (Color online) Detailed results for the velocity of the projectile for different aligned coil length in the case of an overlapped coilgun.

shown in Fig. 12, to show the effect of the overlapped length as it appears beneath 100 mm of its journey inside of the barrel.

Finally, we can comment that the overlapped case can achieve a better muzzle velocity relative to the non-overlapped coilgun. This improvement is clearer where the spacing between the two main coils increases as a result of the overlap in the coil contribution. However, the overlapped configuration introduces better results.

### 3.3.2. Effect of the Change in the Coil length

The previous section described how the overlapped coilgun achieves better results than a conventional configuration. The previous results were based on the selected aligned coil length of 60 mm. In this section, we will thus study the effect of changing the length of the aligned coils “L1 and L2” for the overlapped structure on the velocity of the projectile. The best overlapped distance was “OL” = 5 mm, spacing = 40 mm. The length of the aligned coils

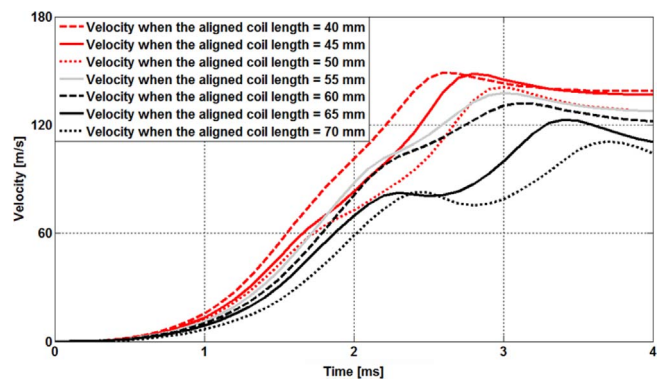

**Fig. 14.** (Color online) Detailed velocities for the different coil lengths starting from 40 mm to 70 mm for the non-overlapped coilgun.

**Table 2.** Projectile's muzzle velocity for different lengths of aligned coils for an overlapped/non-overlapped medium caliber coilgun.

Length of aligned coils [mm]	Overlapped Configuration	Non Overlapped Configuration
	Projectile's muzzle velocity [m/sec]	Projectile's muzzle velocity [m/sec]
40	169.4	149.1
45	169.3	148.4
50	168.8	141
55	168.1	137.6
60	167.2	132.1
65	162.2	123.1
70	160.2	110.9

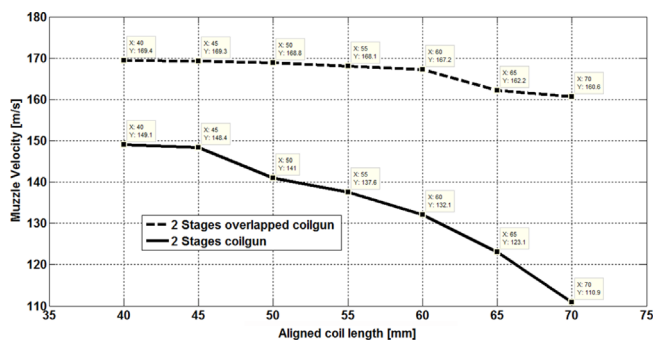

**Fig. 15.** (Color online) Velocity comparison between the two-stage coilgun and two-stage overlapped coilgun for the same spacing between the aligned coils.

“L1 and L2” will vary seven times from 40 mm to 70 mm, with an increase of 5 mm each time.

The detailed results for all cases studies are shown in Fig. 13. There is an inversely proportional relation between the length of the aligned coils and the velocity of the projectile: as the length of aligned coils increases, the velocity of the projectile decreases.

For the sake of comparison, the results for the detailed velocities of the non-overlapped configuration are plotted in Fig. 14 for each of the studied cases, starting from 40 mm to 70 mm. It is obvious that, as presented before, the increase in the length of the aligned coils will decrease the muzzle velocity. Moreover, a comparison of Figs. 13 and 14 in terms of the muzzle velocity indicates that the overlapped configuration not only increase the muzzle velocity but also preserve the velocity the profile from deformation. The comparison of the muzzle velocity of the projectile can be plotted more clearly in Fig. 15. Also, the values from the figure are presented in Table 2 for the

seven cases that were studied. From Fig. 15, we can claim that the drop in the velocity for the longer coil is reduced in the case of the overlapped configuration, and this can be explained to be a consequence of the compensation of the reverse flux linkage in the two main coils by a forward flux linkage of the overlapped coil. This point needs to be investigated, and also the effect of the current flow through the overlapped coil should be further studied.

## 4. Conclusion

A new configuration has been introduced for a coilgun. The theoretical concept of the proposed configuration is discussed, and the design of the coilgun excitation circuit was introduced. The proposed overlapped coilgun launcher has been tested for ten different cases with different spacing and length of the overlapped coil. The results indicate that for each of the ten cases, the exit velocity of the overlapped coilgun was better than the exit velocity of non overlapped case with the same length (up to 33% increase). Moreover, the proposed overlapped coilgun can be applied for multi-stage configurations for higher weighted projectiles.

## References

- [1] O. Gurhan, M.Sc. Thesis, Monterey, California (2001).
- [2] D. C. Lamppa, C. J. Garasi, A. C. Robinson, T. V. Russo, D. N. Shirley, and M. S. Aubuchon, USA Patent, Sandia National Labs, USA (2008).
- [3] S. Liu, J. Ruan, D. Huang, and Z. Wan, IEEE IPEDC **09**, 845 (2009).
- [4] R. J. Kaye, IEEE Tran. Magn. **41**, 194 (2005).
- [5] W. Liu, C. Yanjie, Y. Zhang, J. Wang, and D. Yang, IEEE Trans. Plasma Sci. **39**, 100 (2011).
- [6] Y. Zhang, K. Liu, J. Liao, Y. Zhang, C. Wu, and Y. Hu, 16<sup>th</sup> Int. EML Symp. **1**, 100 (2012).
- [7] L. Guo, N. Guo, S. Wang, J. Qiu, J. Guo Zhu, Y. Guo, and Y. Wang, IEEE Energy Con. Congress and Exp. **1**, 234 (2009).
- [8] K. E. Eeinhard, M.Sc. Thesis, University of Texas, Austin (1992).
- [9] M. Barry, IEEE Trans. Mag. **29**, 701 (1993).
- [10] S. Liu, J. J. Ruan, P. Ying, Y. J. Zhang, and Y. D. Zhang, IEEE Trans. Plasma Sci. **39**, 382 (2011).
- [11] H. M. Mohamed, M. A. Abdalla, A. A. Mitkees, and W. S. Sabery, ICET **1**, 1 (2014).
- [12] H. M. Mohamed, M.Sc. Thesis, MTC College, Egypt (2014).