

Multi-physics Analysis for Temperature Rise Prediction of Power Transformer

Hyun-Mo Ahn*, Joong-Kyoung Kim**, Yeon-Ho Oh***, Ki-Dong Song***
and Sung-Chin Hahn[†]

Abstract – In this paper, a method for multi-physics analysis of the temperature-dependent properties of an oil-immersed transformer is discussed. To couple thermal fields with electromagnetic and fluid fields, an algorithm employing a user defined function (UDF) is proposed. Using electromagnetic analysis, electric power loss dependent on temperature rise is calculated; these are used as input data for multi-physics analysis in order to predict the temperature rise. A heat transfer coefficient is applied only at the outermost boundary between transformer and the atmosphere in order to reduce the analysis region. To verify the validity of the proposed method, the predicted temperature rises in high-voltage (HV) and low-voltage (LV) windings and radiators were compared with the experimental values.

Keywords: Electric power loss, Multi-physics analysis, Numerical analysis, Power transformer, Temperature rise

1. Introduction

Magnetic circuits and windings are principal sources of loss, and thus of temperature rise, in a transformer. Core and copper losses are mainly responsible for heat generation, and such heat must be dissipated in order to keep the core and winding parts from reaching a temperature that will cause deterioration of the insulation [1, 2]. As maximum allowable temperatures depend on factors such as the ambient temperature, transformer design, loading condition, and amount of cooling provided, the accurate estimation of the transformer temperature is critical design factor, and limits for temperature rise are specified in International Standard [3].

In general, temperature rise can be predicted by means of a heat transfer analysis using the finite element method (FEM) or by mean of a heat fluid analysis using the finite volume method (FVM). Of these two, heat transfer analysis has the advantage of requiring less computing time, but has poor accuracy for circuits with complex geometry. Thermal fluid analysis, on the other hand, is more accurate over a wide range of circuit geometries, but requires a longer computing time; thus, in order to improve the fluid transfer analysis, it is necessary to develop new methods for reducing the computing time [4, 5].

Previous work concerning the thermal dynamics of power transformers has been conducted by Marina A. Tsili and Eleftherios I. Amoiralis [4], who derived a hybrid numerical-analytical technique for power transformer thermal modeling, and by Carlos Ortiz and Adam W. Skorek [5], who performed a parallel computational fluid dynamics (CFD) analysis of conjugate heat transfer in a dry-type transformer. Although these studies produced some interesting results, they mainly investigated the thermal problem itself, as opposed to the interactions of the physical processes of the thermal, electromagnetic, or fluid fields; as such, accurate temperature rise prediction was not attempted.

In our previous works [6, 7], we dealt with coupled problem such as electromagnetic-thermal field of oil-immersed power transformer. We mainly investigated coupled electromagnetic-thermal problem.

Now, in this paper, a multi-physics analysis that can produce an accurate temperature rise prediction in an oil-immersed transformer is presented to obtain the more accurate results than our previous works [6, 7]. To couple thermal, electromagnetic, and fluid fields, an algorithm employing an UDF [8] is proposed.

In order to accurately predict the temperature rise, accurate modeling of heat sources is needed. Electric power losses can be calculated by means of electromagnetic analysis; in order to do so accurately, the copper loss can be considered to be temperature-dependent, whereas the core loss can be accurately estimated using Bertotti's model [9, 10] as derived from Steinmetz's equation. Electric power losses calculated in this way can then be used as input data for multi-physics analysis; in order to predict the temperature rise accurately, the

[†] Corresponding Author: Dept. of Electrical Engineering, Dong-A University, Korea. (schahn@dau.ac.kr)

* Dept. of Electrical Engineering, Dong-A University, Korea. (hmahn@donga.ac.kr)

** R&D Center, Power & Industrial System Performance Group, HYOSUNG Corporation, Korea. (jkkim1976@hyosung.com)

*** Power Apparatus Research Center, HVDC Research Division, Korea Electrotechnology Research Institute, Korea. (yhoh@keri.re.kr)

Received: March 1, 2013; Accepted: June 25, 2013

material properties of cooling oil can be considered to be temperature-dependent. Also, we apply heat transfer coefficient obtained by calculating the Nusselt number [11] at only the outermost boundary between the transformer and the atmosphere this restriction is applied in order to reduce the computing time. To verify the validity of this proposed analysis method, its results in terms of temperature rise in the high-voltage (HV) and low-voltage (LV) windings and radiator can be compared with the experimental results.

2. Multi-Physics Analysis Model

The transformer studied was an oil-immersed, single-phase unit (1MVA, 6600/690V, 60Hz). The multi-physics analysis model used to assess power loss in this transformer has an electromagnetic and a thermal-fluid component; to reduce the computing time, the electromagnetic component, shown in Fig. 1(a), consists of a reduce model of the transformer core and approximate windings, whereas the thermal-fluid component, shown in Fig. 1(b), consists of a model of the transformer parts. To reduce the analysis region, we applied a quarter symmetry model to determine boundary conditions such as the symmetry boundary and the heat transfer coefficient.

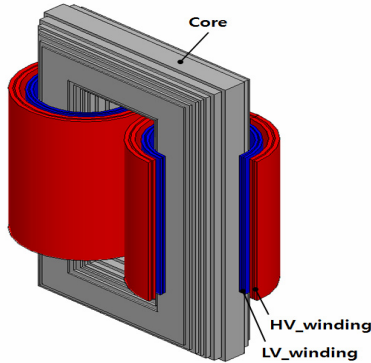

(a) Electromagnetic model

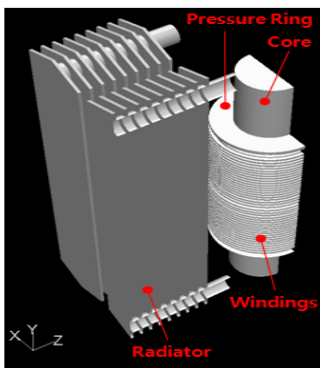

(b) Thermal-fluid model

Fig. 1. Multi-physics analysis models

3. Multi-Physics Analysis

3.1 Multi-physics analysis method

In order to obtain an accurate analysis of characteristics of the transformer system, an assessment of the relationships between multi-physical phenomena (multi-physics) is required. For the study described in this paper, we employed a user defined function (UDF) algorithm to solve the multi-physical problem of coupled thermal, electromagnetic and fluid fields. Some of the material properties relevant to both the electromagnetic and the fluid fields are dependent on temperature and thus on the thermal effects; Fig. 2 shows the multi-physics algorithm used to assess the material properties that are dependent on the temperature characteristics.

As can be seen in the Fig. 2, the process involves calculating electric power losses using electromagnetic analysis and then predicting temperature rise using thermal-fluid analysis, with this sequence of analysis iteratively processed until the temperature reaches a steady state.

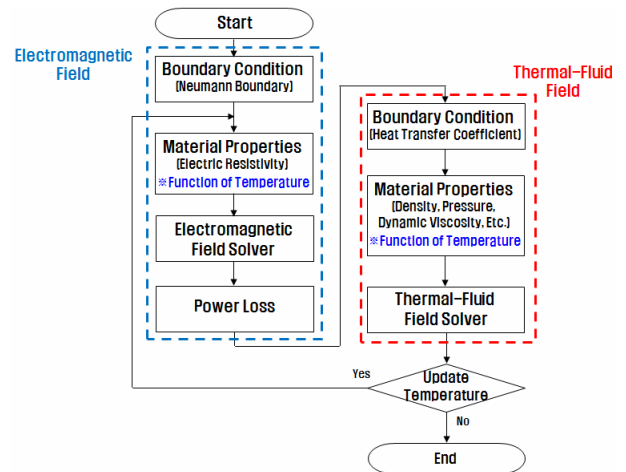

Fig. 2. Flow chart of multi-physics analysis

3.2 Analysis of electric power loss (Heat Source)

Two main types of losses can occur in an electric power transformer: copper loss and core loss [1]. The amount of copper loss incurred can be calculated as a function of the main current running through the primary and secondary windings.

$$P_w = \frac{1}{2\sigma_e} \int J_s^2 dv \quad (1)$$

where P_w is the power loss in the coil winding [W], σ_e is the electric conductivity [S/m], J_s is the current density [A/m^2], and dv is the incremental volume element [m^3]. The electrical properties of copper are dependent on

Table 1. Core Loss Coefficients @ 60Hz (Calculation)

Hysteresis Loss Coefficient	Classical Eddy Current Loss Coefficient	Excess Eddy Current Loss Coefficient
37.72	0.35	1.34

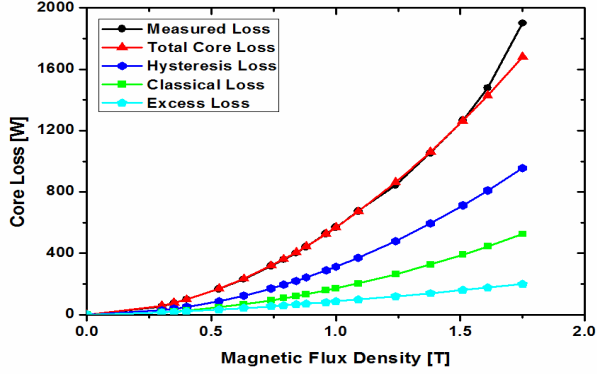
Fig. 3. Core losses due to the magnetic flux density @60Hz

temperature, with the resistivity changing as temperature increases and the power loss correspondingly increasing:

$$P_w(T) = \frac{\rho_{e,0} [1 + \alpha_c (T - T_0)]}{2} \int J_s^2 dv \quad (2)$$

where α_c is the temperature coefficient, $\rho_{e,0}$ is the baseline electric resistivity [$\Omega\cdot\text{m}$] of copper, and T is the temperature [$^{\circ}\text{C}$]. Thus, at 20 [$^{\circ}\text{C}$], the calculated initial copper losses of HV and LV windings are 163,020.6 [W/m^3] and 188,305.7 [W/m^3], respectively.

Core losses can be grouped into two loss categories [1]: hysteresis loss and eddy current loss. Hysteresis loss, which varies as a function of frequency, can be defined as the area within a static magnetization loop. Eddy current losses can be further subdivided into classical eddy current losses and excess eddy current losses. The classical eddy current loss can be derived from Maxwell's equation and is proportional to the square of the frequency, whereas the excess eddy current loss is a residual core loss mechanism (i.e., one that is not described by hysteresis loss or classical eddy current loss); it is mathematically defined as the total core loss minus the hysteresis and classical eddy current losses. Total core loss can then be separated using Bertotti's model [9, 10, 12].

$$P_c = k_h f B_m^2 + k_c (f B_m)^2 + k_e (f B_m)^{1.5} \quad (3)$$

where P_c is the core loss [W]; k_h , k_c and k_e are the hysteresis loss coefficient, classical eddy current loss coefficient, and excess eddy current loss coefficient, respectively; f is the frequency [Hz]; and B_m denotes the maximum flux density [T]. Bertotti's model can be used to mitigate errors arising from the use of Steinmetz's



(a) Magnetic flux density distribution

(b) Core loss distribution

Fig. 4. Magnetic field analysis results of a transformer core

equation, which is typically less accurate over a maximum operating magnetic flux density of 1 [T]. In order to solve Bertotti's model, the three core loss coefficients can be analytically calculated by using core loss data (the B-P curve) shown in Table 1; in this case, the total core loss owing to the magnetic flux density is analytically calculated by using core loss coefficients, as shown in Fig. 3.

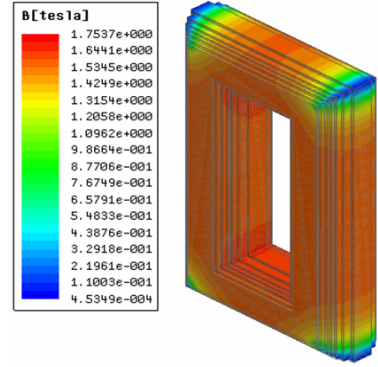
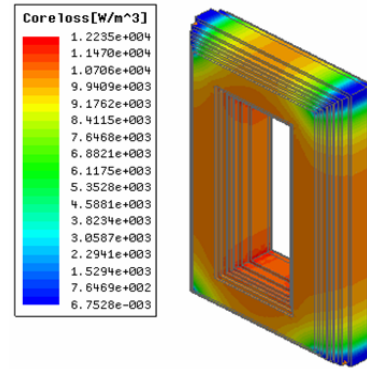
The total core loss shown in Fig. 3 is the sum of the hysteresis loss, the classical eddy current loss, and the excess eddy current loss, and there is a good agreement between the measured loss and the calculated total core loss values over the operating range of a power transformer. The magnetic flux density and core loss distributions in the transformer core can be numerically calculated by using an FEM for a transformer's magnetic field, as shown in Fig. 4.

Here, it can be seen that the average magnitude of loss at the transformer core is 1,357.1 [W]; this represents an error of approximately 7.9 [%] compared to the design value. The electric power losses generated by combining the initial copper and core losses in this method can then be used as input data for a multi-physics analysis.

3.3 Temperature ri analysis

A heat transfer mechanism requires the existence of a temperature difference; additionally, in all modes of heat

transfer, movement of heat proceeds from a higher to a lower temperature medium. Heat transfer in a transformer is effected through conduction, convection, and radiation, given respectively as below [4, 8]:

$$\text{Conduction : } \dot{Q}_{cond} = -kA\nabla T \quad (4)$$

$$\text{Convection : } \dot{Q}_{conv} = hA(T_w - T_\infty) \quad (5)$$

$$\text{Radiation : } \dot{Q}_{radi} = A\varepsilon\sigma(T_1^4 - T_2^4) \quad (6)$$

where, \dot{Q} is the heat flow [W], k is the thermal conductivity [W/m \cdot °C] of the medium, A is the cross section [m 2], ε is the surface emissivity, and σ is the Boltzmann constant [W/m 2 \cdotK 4].

Heat transfer in an oil immersed transformer mainly occurs by circulation of cooling oil. Heat generated by electric power losses is transmitted to tank and radiator. According to law of energy conservation, the energy balance equations in insulation oil are given as below [2].

$$Q_{gen} = (mc_p)_{c,w} \frac{dT_{c,w}}{dt} + h_c A_c (T_c - T_o) \quad (7)$$

$$\begin{aligned} & h_c A_c (T_c - T_o) \\ &= (mc_p)_o \frac{dT_{c,w}}{dt} + h_{t,i} A_t (T_o - T_t) + h_{r,i} A_r (T_o - T_r) \end{aligned} \quad (8)$$

where, Q_{gen} is heat source [J] and m is mass [kg]. The heat transfer coefficient can then be defined on the solid-fluid boundary (i.e., the tank and the radiator). In order to reduce computing time, the boundary condition defined average heat transfer coefficient can be obtained practically by applying Nusselt number [11].

$$h = \frac{k}{\delta} Nu \quad (9)$$

where, Nu is the Nusselt numbers, h is the heat transfer coefficient [W/m 2 \cdot°C] and δ is the characteristic length [m].

Typically, the heat transfer in a power transformer is primarily influenced by the circulation of the cooling oil, the fluid dynamics of which can be modeled using CFD. Fluid flow and temperature distribution within a transformer are governed by three conservation equations. These can be solved simultaneously with a semi-implicit method for pressure-linked equations (SIMPLE) algorithm, which uses a combination of continuity and momentum equations in order to derive an equation for pressure correction [5, 13, 14]:

$$\text{Continuity equation : } \nabla \cdot \rho \vec{v} = 0 \quad (10)$$

$$\text{Momentum equation : } \rho \frac{D\vec{v}}{Dt} = \rho \vec{g} - \nabla p + \mu \nabla^2 \vec{v} \quad (11)$$

$$\text{Energy equation : } \rho c_p \frac{DT}{Dt} = \nabla^2 (kT) + \mu \Phi + q' \quad (12)$$

where, ρ is the density [kg/m 3], \vec{v} is the velocity [m/s], \vec{g} is the acceleration of gravity [m/s 2], μ is the viscosity [kg/m\cdot s], p is the pressure [N/m 2], c_p is the specific heat of the fluid at constant pressure [J/kg\cdot°C], Φ is a dissipation function, and q' is the energy per unit volume [W/m 3]. Turbulence phenomena in the cooling oil can be modeled using a $k-\varepsilon$ turbulence model having two transport equations one dealing with the kinetic energy of turbulence and the other involving the dissipation rate.

Many properties of the cooling oil are affected by temperature as below [13].

$$c_{p,oil} = 807.163 + 3.58 T_{oil} \quad (13)$$

$$\rho_{oil} = 1098.72 - 0.712 T_{oil} \quad (14)$$

$$k_{oil} = 0.1509 - 7.101 \times 10^{-5} T_{oil} \quad (15)$$

$$\mu_{oil} = 0.08467 - 4 \times 10^{-4} T_{oil} + 5 \times 10^{-7} T_{oil}^2 \quad (16)$$

As shown in Fig. 5, it can be seen that the specific heat increases linearly with temperature, whereas the density and thermal conductivity decrease linearly with temperature and the dynamic viscosity decreases in a non-linear manner. In fact, except for viscosity, all the cooling oil properties change linearly with temperature.

The temperature distributions in a power transformer are shown in Fig. 6: sequential and multi-physics analyses show maximum temperatures of 84.9 [°C] and 111.7 [°C], respectively, at the upper part of the LV winding. This maximum temperature at the upper part is attributed to the fact that while heat flow in the duct region of the inner winding is reduced by the mechanical and insulation structure, and thermal energy in the cooling oil moves upwards owing to buoyancy. Furthermore, as the amount of heat generated in the LV winding is greater than that in the HV winding, the temperature in the region of the LV winding is higher than that in the region of the HV winding. A comparison of the results of the temperature distribution by both the sequential and multi-physics analysis models shows a maximum temperature differential between the two of 26.8 [°C] because heat sources are increased by

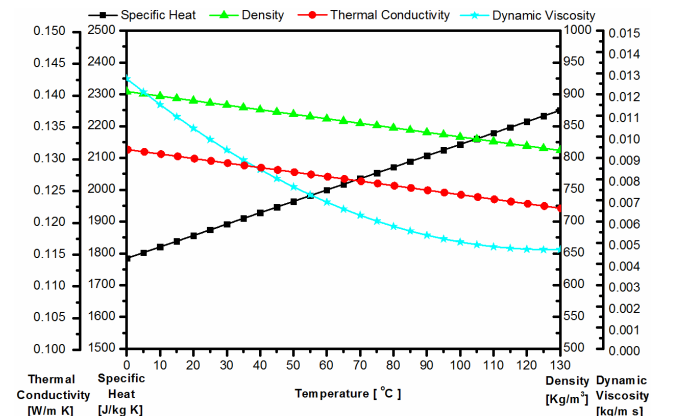
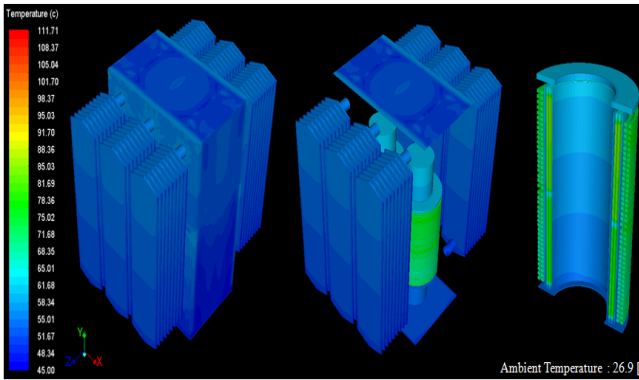
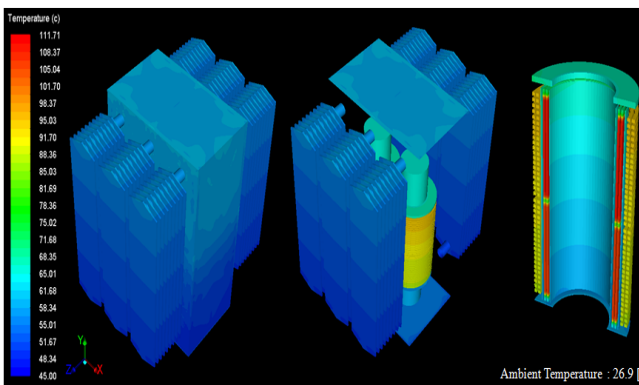

Fig. 5. Properties of cooling oil



(a) Sequential analysis



(b) Multi-physics analysis

Fig. 6. Temperature distribution

temperature rise. In order to verify the validity of multi-physics analysis, the temperatures rise at certain points on the HV and the LV windings as well as the radiator were measured using a temperature rise test and then compared with the numerically predicted results.

As can be seen in Fig. 7, the amount of temperature rise predicted by the multi-physics analysis model showed greater agreement with the experiment than that predicted by the sequential model.

4. Conclusion

In this paper, a multi-physics analysis used to predict the temperature rise in an oil-immersed transformer was described. In this method, an algorithm using a UDF is performed in order to couple thermal, electromagnetic field, and fluid fields. To accurately predict the temperature rise, accurate modeling of heat sources is required. In order to calculate heat source parameters accurately, copper loss is considered to be temperature dependent, and core loss is calculated using Bertotti's model. The numerically calculated magnetic flux density values and the analytically calculated core loss coefficients could be used to solve this model. The results from this method agreed well with the

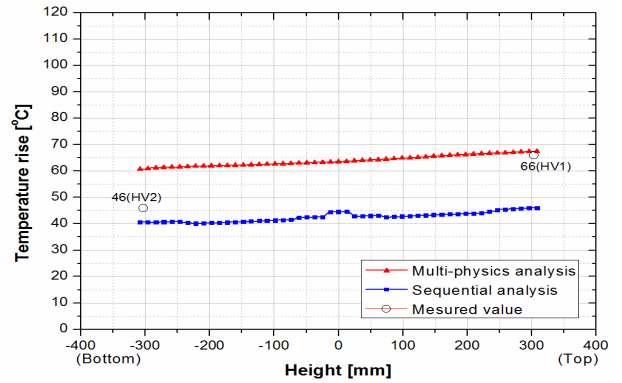

(a) HV windings

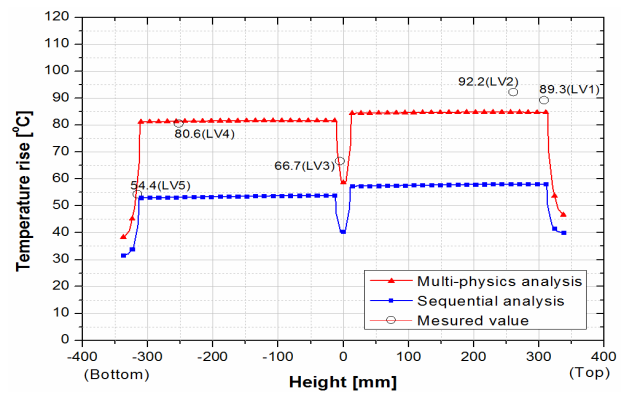

(b) LV windings

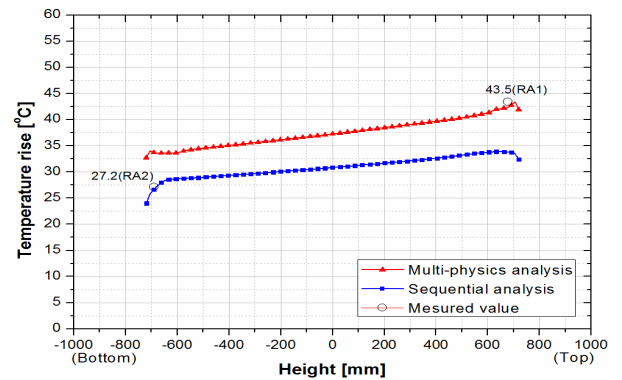

(c) Radiators

Fig. 7. Comparison of temperature rise results

design values.

To reduce the region of analysis, we used a quarter symmetry model determined by the boundary conditions such as the symmetry boundary and the heat transfer coefficients. The electric power losses and boundary conditions thus calculated were then used as input data for multi-physics analysis; in order to predict the temperature rise accurately, the material properties of cooling oil considered to be temperature-dependent. In order to verify the validity of the analysis, the predicted temperature rises in the HV and LV windings and radiator were compared

with the experimental values. From this, it could be seen that the temperature rise predicted by the multi-physics analysis is closely in accord with the experimentally obtained values; this gives us confidence that the method proposed in this paper will be useful in improving the thermal design of power transformers.

Acknowledgements

This work was supported by the Dong-A University research fund.

References

- [1] S. V. Kulkarni and S. A. Khaparde, *Transformer Engineering - Design and Practice*, Marcel Dekker, Inc., 2004.
- [2] G. L. Alegi and W. Z. Black, "Real-time thermal model for an oil-immersed, forced-air cooled transformer", *IEEE Trans. on Pow. Del.*, Vol. 5, No. 2, pp. 991-999, Apr. 1990.
- [3] IEEE C57.91-1995-*IEEE Guide for Loading Mineral-Oil-Immersed Transformers*.
- [4] Marina A. Tsili, Eleftherios I. Amoiralis, Antonios G. Kladas, and Athanassios T. Souflaris, "Hybrid numerical-analytic technique for power transformer thermal modeling", *IEEE Trans. Magn.*, Vol. 45, No. 3, pp. 1408-1411, Mar. 2009.
- [5] C. Ortiz, A.W. Skorek, M. Lavoie, and P. Benard, "Parallel CFD analysis of conjugate heat transfer in dry-type transformer", *IEEE Trans. Ind. Appl.*, Vol. 45, No. 4, pp. 1530-1534, Jul-Aug. 2009.
- [6] H. M. Ahn, M. S. Kim, J. S. Song, S. C. Hahn, "A study of coupled electromagnetic-thermal field analysis for temperature rise prediction of power transformer", *Trans. KIEE*, Vol. 60, No. 10, pp. 1838-1845, Oct. 2011.
- [7] H. M. Ahn, B. J. Lee, and S. C. Hahn, "An efficient investigation of coupled electromagnetic-thermal-fluid numerical model for temperature rise prediction of power transformer", in *Proceedings of ICEMS 2011 Conference*, Beijing, China, Aug. 2011.
- [8] *Fluent Product Documentation*, Release 12.1, Ansys Inc., 2011.
- [9] Yamazaki, K. and Fukushima, N., "Iron-loss modeling for rotating machines: comparison between Bertotti's three-term expression and 3-D eddy-current analysis", *IEEE Trans. Magn.*, Vol. 46, No. 8, pp. 3121-3124, Aug. 2010.
- [10] G. Bertotti, "General properties of power losses in soft ferromagnetic materials", *IEEE Trans. Magn.*, Vol. 24, No. 4, pp. 621-630, Jan. 1988.
- [11] J. K. Kim, S. C. Hahn, K. Y. Park, H. K. Kim, and Y. H. Oh, "Temperature rise prediction of EHV GIS bus bar by coupled magneto-thermal finite element method", *IEEE Trans. Magn.*, Vol. 41, No. 5, pp. 1636-1639, May. 2005.
- [12] M. V. F. da Luz, J. V. Leite, A. Benabou, and N. Sadowski, "Three-phase transformer modeling using a vector hysteresis model and including the eddy current and the anomalous losses", *IEEE Trans. Magn.*, Vol. 46, No. 8, pp. 3201-3204, Aug. 2010.
- [13] N. El Wakil, N.-C. Chereches, and J. Padet, "Numerical study of parameters affecting the temperature distribution in a disc-type transformer winding", *J. Therm. Sci.*, Vol. 45, No. 6, pp. 615-626, 2006.
- [14] J. Smolka and A. J. Nowak, "Shape optimization of coils and cooling ducts in dry-type transformers using computational fluid dynamics and genetic algorithm", *IEEE Trans. Magn.*, Vol. 47, No. 6, pp.1726-1731, Jun. 2011.

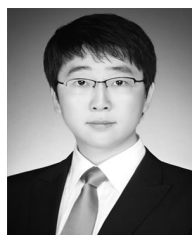

Hyun-Mo Ahn He received the B.S. and M.S. degrees in electrical engineering from Dong-A University, Busan, Korea, in 2009 and 2011, respectively. He is currently working toward the Ph.D. degree. His research interests are multi-physics analysis and numerical analysis of power apparatus and electric

machines.



Joong-Kyoung Kim He received the B.S., M.S., and Ph.D. degrees in electrical engineering from Dong-A University, Busan, Korea, in 2002, 2004 and 2008, respectively. He is currently a Chief Researcher with the R&D Center, Power & Industrial Systems Performance Group, HYOSUNG Corporation.

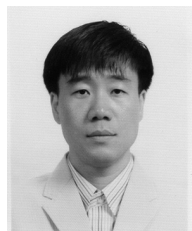

Yeon-Ho Oh He received the B.S. and M.S. degrees in electrical engineering from Dong-A University, Busan, Korea, in 1991 and 1993, respectively. He is currently a Research Engineer with the Power Apparatus Research Center, HVDC Research Division, Korea Electrotechnology Research Institute (KERI).



Ki-Dong Song He received the B.S. and M.S. degrees in electrical engineering from InHa University, Incheon, Korea, in 1988 and 1990, respectively. He got his Ph.D. degree in electrical engineering from Busan National University in 2003. He worked for Korea Electrotechnology Research Institute (KERI) from 1990 and is now the director of the Power Apparatus Research Center, HVDC Research Division. His research interests focus on analysis and design for AC Power Devices and HVDC circuit breakers.



Sung-Chin Hahn He received the B.S., M.S., and Ph.D. degrees in electrical engineering from Seoul National University, Seoul, Korea, in 1979, 1981, and 1992, respectively. He is currently a Professor with the Department of Electrical Engineering, Dong-A University, Busan, Korea. His current research covers multi-physics analysis and optimal design of power apparatus and electric machines.