

10-Gbit/s Wireless Communication System at 300 GHz

Tae Jin Chung and Won-Hui Lee

A 10-Gbit/s wireless communication system operating at a carrier frequency of 300 GHz is presented. The modulation scheme is amplitude shift keying in incoherent mode with a high intermediate frequency (IF) of 30 GHz and a bandwidth of 20 GHz for transmitting a 10-Gbit/s baseband (BB) data signal. A single sideband transmission is implemented using a waveguide-tapered 270-GHz high-pass filter with a lower sideband rejection of around 60 dB. This paper presents an all-electronic design of a terahertz communication system, including the major modules of the BB and IF band as well as the RF modules. The wireless link shows that, aided by a clock and data recovery circuit, it can receive 2^7-1 pseudorandom binary sequence data without error at up to 10 Gbit/s for over 1.2 m using collimating lenses, where the transmitted power is 10 μ W.

Keywords: Terahertz wireless communication, incoherent, single sideband, 300 GHz, Schottky barrier subharmonic mixer, frequency tripler, diagonal horn antenna, 10 Gbit/s.

I. Introduction

Terahertz (THz) communication systems have been extensively developed among various THz applications taking full advantage of ultra-wide bandwidths, which enables high-speed communications of above 10 Gbit/s with simple and low spectral efficiency modulation schemes, for example, amplitude shift keying (ASK) or on-off keying (OOK). Many experimental demonstrations in the frequency range of 220 GHz to 350 GHz have been reported [1]-[5]. Each of these demonstrations has shown the feasibility of THz communication systems for commercialization in the near future.

The application scenarios may include fixed wireless access, THz nanocells, a wireless local area network, a wireless personal area network, short-range connecting devices, Kiosk downloading, and board-to-board communications [6], [7].

Although the RF bandwidth in the THz frequency range can be considered extremely wide, for example, over 40 GHz in a single channel at 300 GHz to 400 GHz [8], the question remains as to whether this wide bandwidth can also be utilized at the baseband (BB) or intermediate frequency (IF) band for modulation and demodulation electronics used in communication systems. However, the modem electronics used in THz communication systems must be simple and inexpensive.

There are two approaches used in communication systems: coherent and incoherent. Although a coherent architecture achieves a desirable system performance, the complexity of the receiver is increased. An incoherent approach, on the other hand, can be implemented using a significantly less complex receiver architecture. The authors of [1] and [2] adopted a coherent architecture in the RF frontend based on all active monolithic microwave integrated circuits and demonstrated data transmissions of up to 25 Gbit/s. On the other hand, the

Manuscript received June 4, 2012; revised Oct. 25, 2012; accepted Nov. 6, 2012.

This work was supported by the IT R&D program of MKE/KCC/KEIT (KI002056, Development of Radio Wave Propagation Environment and Wireless Transmission Platform Technologies in Tera-Hertz Frequency Range).

Tae Jin Chung (phone: +82 42 860 5086, tjchung@etri.re.kr) and Won-Hui Lee (corresponding author, whlee07@etri.re.kr) are with the Broadcasting & Telecommunications Media Research Laboratory, ETRI, Daejeon, Rep. of Korea.

<http://dx.doi.org/10.4218/etrij.13.0112.0351>

authors of [4] and [5] used photonic technologies in the transmitter and a Schottky barrier diode (SBD) detector in the receiver, which is a typical incoherent approach, and demonstrated data transmissions of up to 12.5 Gbit/s and possibly even 20 Gbit/s.

This paper focuses on the practical implementation of a THz communication system with an incoherent approach and a high IF including the BB and IF band electronics and the RF frontends. We design all of the hardware modules, which are fully integrated using commercial RF components, and test them to analyze their wideband characteristics.

This paper presents wireless data transmission experiments at a data rate of up to 10 Gbit/s with a carrier frequency of 300 GHz. We also present modulator and demodulator modules for incoherent communications, in detail. In section II, we describe the design aspects of the entire system, including the design parameters for the transmitter and receiver, the ASK modulator and demodulator, the local oscillator (LO) chain, and the 270-GHz high-pass filter (HPF). In section III, the measurement results of the designed system are given in detail, including the single sideband (SSB) characteristics of the RF frontends, the modulator and demodulator characteristics in the BB and IF band, and the effective antenna gain. In section IV, we present wireless link experiments and discuss some practical issues of the designed system. Finally, we provide some concluding remarks regarding the proposed system in section V.

II. Proposed THz Communication System

1. 300-GHz Transmission System

We adopt the heterodyne scheme as one of the possible THz transceiver architectures to investigate the design aspects of the IF band, such as usable bandwidth, IF selection and filtering, and wideband characteristics of the components. The heterodyne architecture can deliver outstanding overall performances, greatly improving the receiver sensitivity.

The block diagram of the proposed 300-GHz transmission system is shown in Fig. 1. The transmitter consists of a 30-GHz ASK modulator, a subharmonic mixer (SHM), an LO chain, a waveguide-tapered 270-GHz HPF for an SSB transmission, and a diagonal horn antenna, as shown in Fig. 1(a). An attenuator is used to limit the maximum allowable IF power level of the SHM, which is below -3 dBm, based on the manufacturer's data sheet. The heterodyne receiver consists of the same RF frontend as the transmitter in addition to an ASK demodulator, as shown in Fig. 1(b).

The design parameters are summarized in Table 1, which are derived from a link budget analysis with known component

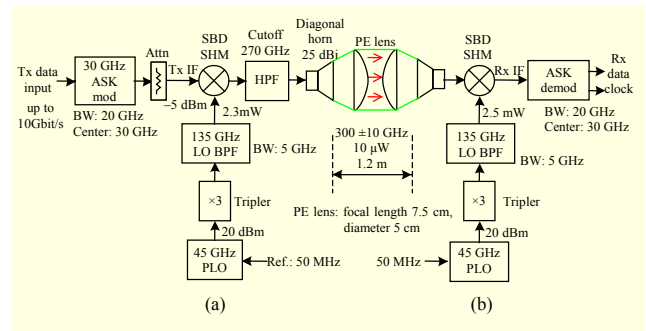

Fig. 1. Block diagram of proposed 10-Gbit/s wireless communication system at 300 GHz : (a) transmitter and (b) receiver.

Table 1. Design parameters of transmitter and receiver.

Parameters	Values	Remarks
Carrier frequency, f_c	300 GHz	$\lambda = 1$ mm
Free space loss	102 dB	@ 10 m
Transmit RF output power, P_t	-20 dBm	10 μ W, measured
Antenna gain, G_t and G_r	25 dBi	WR-2.8Hom (VDI)
Tx and Rx LO frequencies	135 GHz	designed
Tx/Rx LO powers	2.3/2.5 (mW)	@135 GHz
45 GHz PLO power	20 dBm	measured
Tx/Rx SHM conversion losses (DSB)	6/6.5 (dB)	data sheet of WR2.8SHM (VDI)
Receiver noise figure, NF	15 dB	analysis in SSB (dB)
IF center frequency	30 GHz	designed
Transmit IF signal power	-5 dBm	measured
Tx and Rx bandwidths, B	20 GHz	designed
Transmit rate @BER= 10^{-12}	10 Gbit/s	designed
Maximum range, R_{max}	15 cm	without lens

specifications. The theoretical maximum range can be calculated from Friis' formula, neglecting atmospheric gaseous attenuation measured in dB/km for short range indoor communications:

$$R_{max} \cong \sqrt{\frac{P_t \cdot G_t \cdot G_r \cdot \lambda^2}{(4\pi)^2 \cdot SNR_{min} \cdot kT_0 \cdot B \cdot NF}}, \quad (1)$$

the parameters of which are defined in Table 1. Additionally, k is the Boltzman constant, T_0 is the room temperature of 290 K, and SNR_{min} is the minimum signal-to-noise ratio (SNR), which can be derived from the output SNR of the receiver's detector, depending on the modulation method and bit error rate (BER).

The approximate BER versus SNR for incoherent ASK modulation and envelope detection can be estimated from (2) [9] and is plotted in Fig. 2.

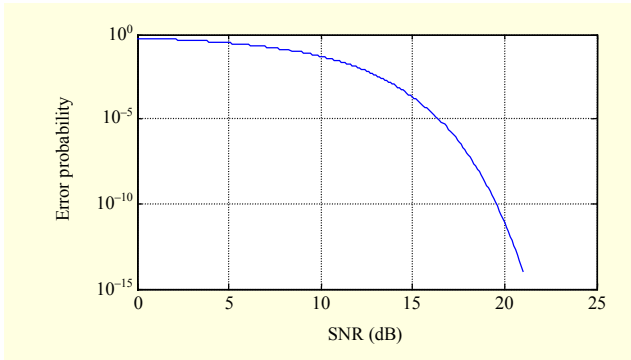

Fig. 2. BER vs. SNR in incoherent ASK modulation and envelope detection.

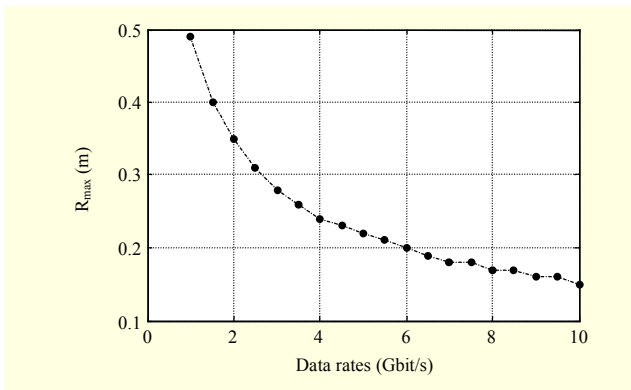

Fig. 3. Theoretical maximum transmission ranges vs. data rates for ASK system.

$$P_e \cong \frac{1}{2} \cdot \left(1 + \sqrt{\frac{1}{\pi \cdot SNR}} \right) \cdot \exp\left(-\frac{SNR}{4}\right). \quad (2)$$

Using (1), the maximum transmission range, R_{\max} , assuming the same NF and BER, is plotted with respect to data rates of 1 Gbit/s to 10 Gbit/s with 0.5-Gbit/s steps, as shown in Fig. 3, using an SNR_{\min} of 20.2 dB at a BER of 10^{-12} , from Fig. 2. The bandwidth B is assumed to be twice that of the data rates. When increasing the antenna gains, the transmission range can be further increased, and the optical lenses can be utilized to effectively increase the antenna gain.

2. Double Sideband and Single Sideband Operations

The THz heterodyne transmitter and receiver system can be operated in two modes, double sideband (DSB) and SSB, when using SBD-based SHMs, which generate only two sidebands, a lower sideband (LSB) and an upper sideband (USB). In addition, a double LO frequency is inherently rejected in a symmetrical anti-parallel diode pair of SHMs. The frequency plans of the transmitter and receiver are shown in Fig. 4. The DSB and SSB operations may be suitable for a low IF of below 10 GHz and a high IF of above 20 GHz,

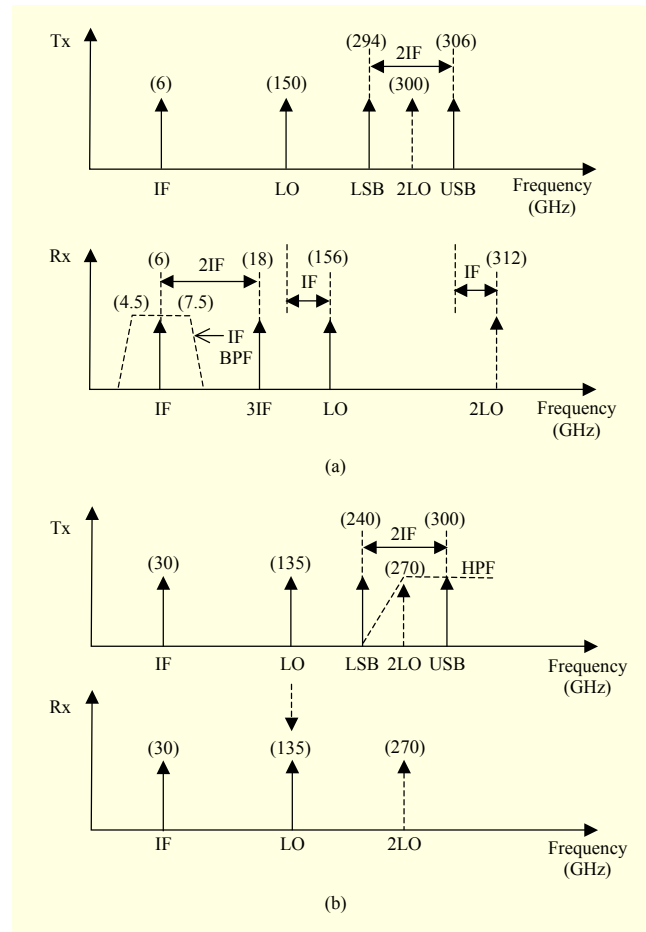

Fig. 4. Frequency plans of transmitter and receiver for (a) DSB and (b) SSB operations.

respectively, in the heterodyne transceiver for the THz bands. The DSB system uses different LO frequencies in the transmitter and receiver, as shown in Fig. 4(a). In the receiver, the received triple IF signal can be easily rejected using a bandpass filter (BPF) in the IF band. In [10], we successfully implemented and demonstrated this scheme for a 1.485-Gbit/s video transmission at 240 GHz and 300 GHz using a 6-GHz IF and a bandwidth of 3 GHz.

The SSB system with a high IF uses the same LO frequencies in the transmitter and receiver, as shown in Fig. 4(b). In the transmitter, one of the two sidebands, LSB or USB, can be rejected using an HPF or BPF, which is implemented for a 10-Gbit/s data transmission, as described in this paper. This system has some disadvantages, including a reduced transmitted power from an additional HPF loss, and the conversion loss of the SHM used increases with a high IF at a rate of 1 dB/15 GHz. In Fig. 4, the variables, IF and LO frequency, are interpreted on the transmitter (Tx) and receiver (Rx) sides, respectively, and each number enclosed in parentheses is an exemplary frequency in GHz.

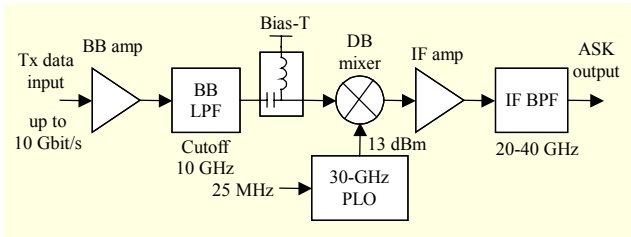

Fig. 5. Block diagram of 30-GHz ASK modulator.

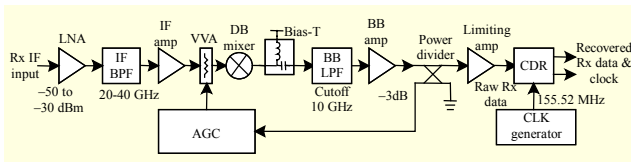

Fig. 6. Block diagram of 30-GHz ASK demodulator.

3. ASK Modulator and Demodulator

The designed ASK modulator is shown in Fig. 5. To transmit data at up to 10 Gbit/s, the necessary continuous transmission bandwidth is 20 GHz in the ASK scheme without a pulse shaping, and the IF must be higher to obtain sufficient bandwidth. In our design, a 30-GHz IF is selected considering the IF operating ranges of the SHMs used, from DC to 40 GHz. The ASK modulator consists of a BB amplifier, a low-pass filter (LPF) with a cutoff frequency of 10 GHz, a bias-T for level shifting from a bipolar to a unipolar signal, an SBD double-balanced (DB) mixer for ASK modulation, an IF amplifier, and an IF BPF with a bandwidth of 20 GHz ranging from 20 GHz to 40 GHz. The LO signal of the DB mixer is generated from a 30 GHz phase-locked oscillator (PLO) with a power level of +13 dBm using a reference clock frequency of 25 MHz.

The designed ASK demodulator, shown in Fig. 6, has the typical configuration of a millimeterwave system, and we therefore do not describe the block diagram in detail; however, certain aspects of the design are described below. The IF input power level of the demodulator is designed to be -50 dBm to -30 dBm with an automatic gain control (AGC) in the BB by controlling the voltage variable attenuator (VVA).

The ASK modulated signal is detected by a combination of an SBD DB mixer, bias-T, and LPF, in which the DB mixer is operated without using an LO signal to drive the mixer; instead, a bias-T simply supplies the DC voltage to the DB mixer for demodulation. In the output, a commercial clock and data recovery (CDR) circuit with an equalizer board is utilized to correctly recover the data and clock from the raw Rx data. The designed wideband IF BPF has a 3-dB fractional bandwidth of 67% and is utilized in Figs. 5 and 6. Using the basic BPF structure shown in Fig. 7(a), a composite microstrip BPF is

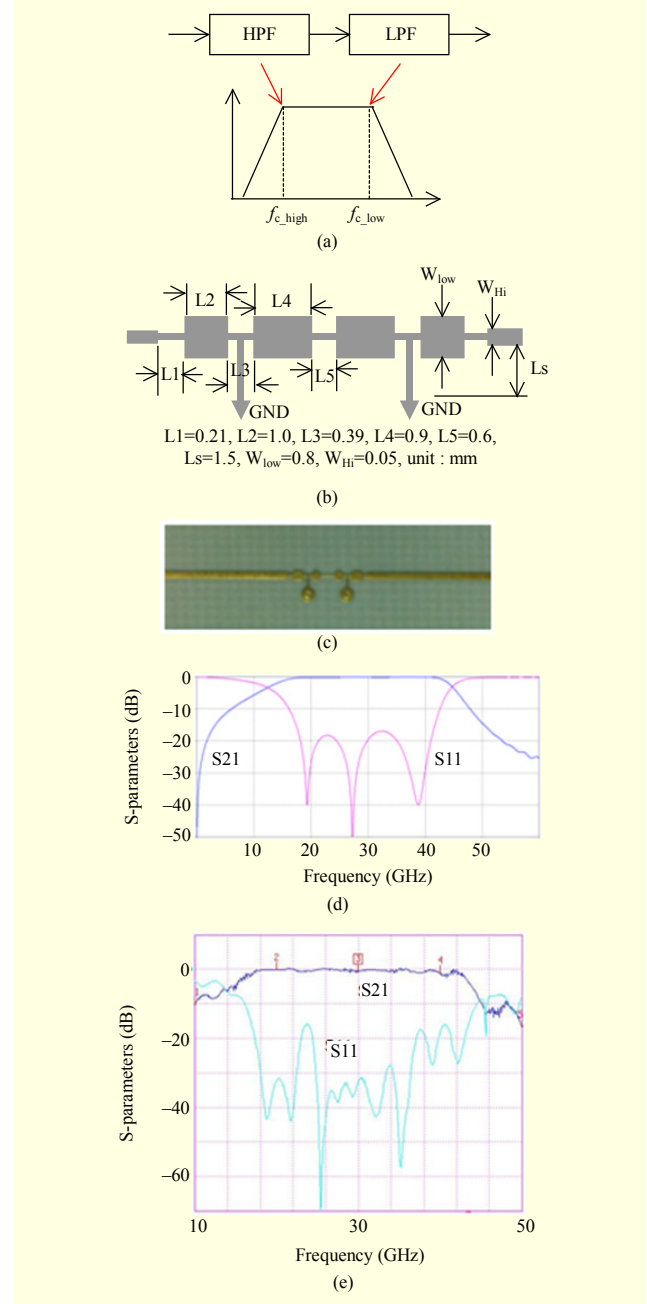

Fig. 7. Designed wideband IF BPF: (a) block diagram, (b) dimensions, (c) photograph, (d) simulated S-parameters, and (e) measured S-parameters.

designed such that an individual HPF and LPF are embedded into each other, as shown in Fig. 7(b), where a stepped-impedance LPF is employed to characterize the upper band, $f_{c,low}$, and quarter-wave short-circuited stubs are used to realize the lower band, $f_{c,high}$, respectively [11], a photograph of which is shown in Fig. 7(c). The simulated S-parameters determined using an Agilent advanced design system (ADS) tool are shown in Fig. 7(d), and the measured S-parameters are shown in Fig. 7(e).

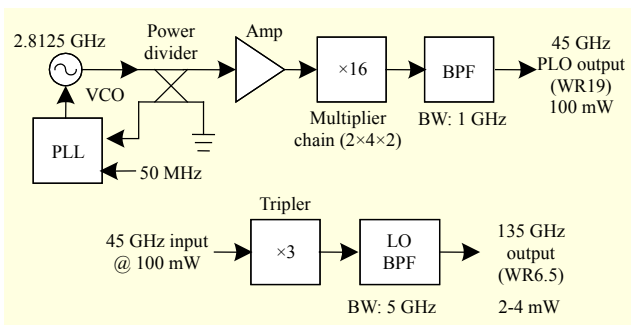

Fig. 8. Block diagram of LO chain for transmitter and receiver.

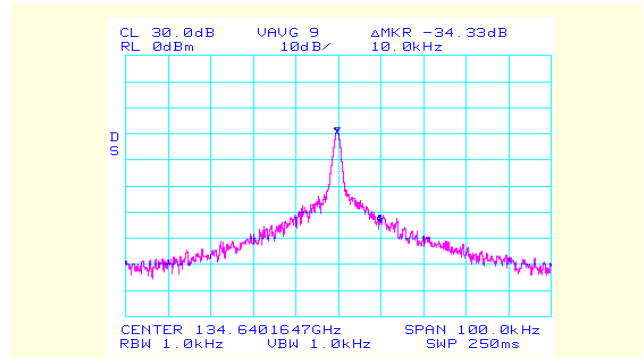

Fig. 10. Measured output power spectrum of LO chain at 135 GHz (actually, 134.64 GHz): phase noise is -64.3 dBc/Hz at 10-kHz offset.

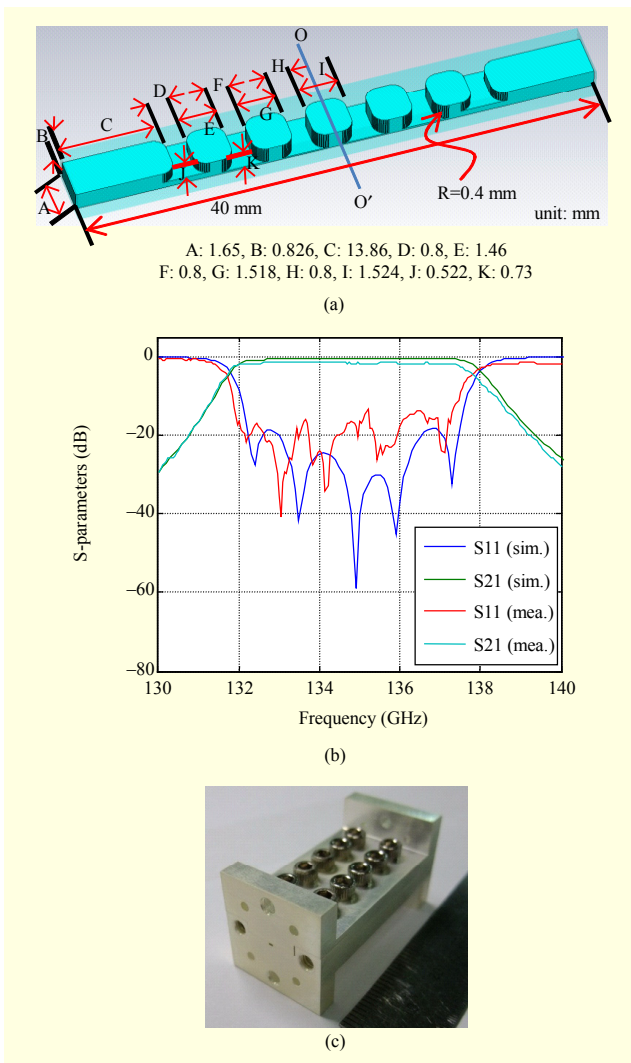

Fig. 9. Designed 135-GHz LO BPF: (a) dimensions, (b) simulated and measured S-parameters, and (c) photograph of device.

4. Local Oscillator Chain

A block diagram of the LO chain is shown in Fig. 8. This module injects LO power to the used SHMs at an optimal

power of 2 mW to 4 mW. The module consists of a 45-GHz PLO, an SBD-based frequency tripler (model: WR6.5 \times 3, VDI Inc.), and an LO BPF for port isolations in the SHMs. The 45-GHz (actually, 44.88 GHz) PLO signal is generated using a phase-locked loop (PLL), a voltage-controlled oscillator (VCO), and a 16-multiplier chain (cascaded in 2 \times 4 \times 2) consisting of an amplifier, filters, and a WR-19 waveguide BPF for connecting to the tripler (\times 3), respectively.

The WR-6.5 waveguide LO BPF with a center frequency of 135 GHz and a bandwidth of 5 GHz is designed and simulated using an Ansys HFSS tool, as shown in Fig. 9. It has five resonators in a symmetrical arrangement with respect to the center line O-O', the dimensions of which are shown in Fig. 9(a). The simulated and measured S-parameters have almost the same characteristics as those shown in Fig. 9(b), with an insertion loss measured at 1.65 dB for 135 GHz. A photograph of the device is shown in Fig. 9(c).

The triplers used in the device have an efficiency of 6.8% at 135 GHz for a 100-mW input drive. The LO output spectrum shown in Fig. 10 is measured using a D-band (110 GHz to 170 GHz) external harmonic mixer (model: M06HWD, OML Inc.). The phase noise is measured to be -64.3 dBc/Hz at a 10 kHz offset. The power meter (PM 4, VDI) measurement shows power levels of 2.3 mW and 2.5 mW for the transmitter and receiver LO chains, respectively.

5. Waveguide-Tapered 270-GHz HPF

To transmit a carrier signal with an SSB, a waveguide HPF is needed in our design. This kind of HPF can be designed simply using a waveguide tapering and transition. The designed WR-3 waveguide HPF has a 3-dB cutoff frequency of 270 GHz with the mechanical dimensions shown in Fig. 11. The simulated and measured S-parameters are also shown in the figure. The insertion loss is measured to be 3.4 dB at 300 GHz. Although the waveguide type is different than that shown in Fig. 9(c),

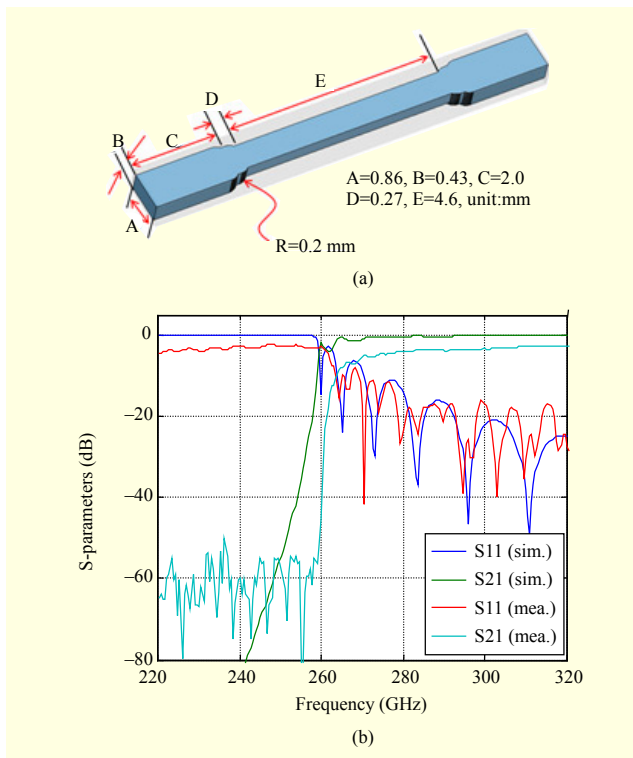

Fig. 11. 270-GHz HPF: (a) dimensions and (b) simulated and measured S-parameters.

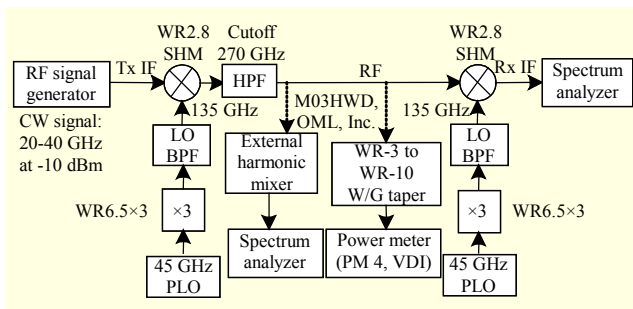

Fig. 12. Test setup for RF frontend measurements.

with a length of 40 mm, a photograph is not shown in Fig. 11 since its appearance is otherwise the same.

III. Measurement Results

1. RF Frontend Characteristics

The RF frontends are characterized through various measurements using the basic configurations shown in Fig. 12. The LO powers injected into the SHMs are approximately 2.5 mW at 135 GHz. With known conversion losses of the SHMs at 300 GHz, we first measure the output spectrum and power level of the transmitter at the HPF output with a 30-GHz continuous wave (CW) IF input signal of -10 dBm from an RF

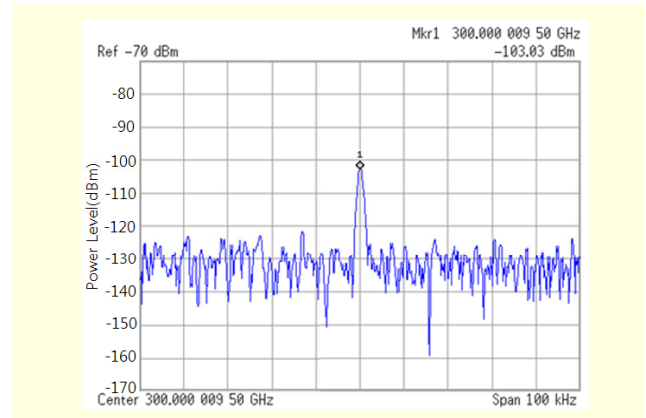

Fig. 13. Transmitted power spectrum at HPF output at IF of 30 GHz with -10 dBm and LO frequency of 135 GHz.

Table 2. Power budget calculation for transmitter at IF = 30 GHz and LO frequency = 135 GHz.

CW IF power	SHM (Tx) loss (SSB)	HPF loss	Ext. mixer loss	Calculated RF power
-10 dBm	11 dB	3.4 dB	77 dB	-101.4 dBm

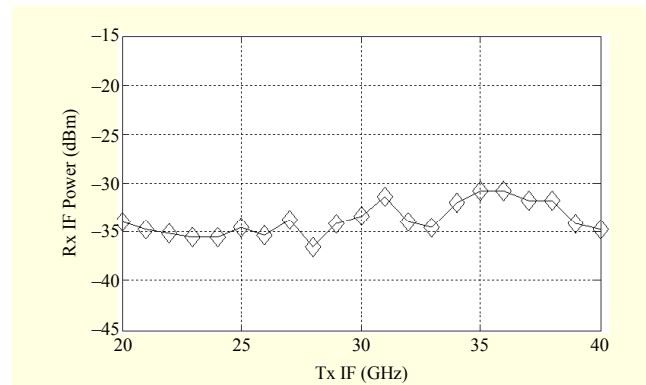

Fig. 14. Received IF power for transmitted IF of 20 GHz to 40 GHz with -5 dBm in SSB test.

signal generator. The output spectrum, which is measured by an external harmonic mixer (model, M03HWD, OML, Inc.) and a spectrum analyzer, is shown in Fig. 13. The conversion loss of the external mixer is approximately 77 dB at 300 GHz. From the spectrum, the transmitted RF power at the HPF output can be estimated to be -26 dBm and show approximately -21 dBm when the IF power input is increased to -5 dBm.

Table 2 provides a summary of the calculated power budget, which shows that the measured power is 1.6 dB lower than the calculated power. In Table 2, the conversion loss of SHM (Tx) is calculated from 9 dB (SSB) plus an additional loss of 2 dB for a 30-GHz IF input at a rate of 1 dB/15 GHz. Alternatively,

the power meter measurement with a calibration factor of 0.8 dB, which is from the manufacturer of the W/G taper and the power meter at 300 GHz, is around $10 \mu\text{W}$ (-20 dBm).

We next perform a Tx IF to Rx IF test to measure the received IF power levels. The Tx IF signal is from 20 GHz to 40 GHz with 1-GHz steps at a power level of -5 dBm . For an SSB test using an HPF connected to two SHMs, the measured Rx IF power on the spectrum analyzer is shown in Fig. 14. As shown in the figure, increasing the Tx IF, the Rx IF power shows the level fluctuations within about 5 dB over 20 GHz to 40 GHz, so that the communication performance may be degraded. In this test, the Rx IF is the same as the Tx IF on the horizontal axis.

2. 30-GHz ASK Modulator and Demodulator Characteristics

To analyze the ASK modulation performances, data transmission experiments are performed using a pulse pattern generator (PPG) as a signal source with a 2^7-1 -PRBS. The modulated output spectra for data rates of 1.5 Gbit/s and 10 Gbit/s are shown in Fig. 15. As can be seen in the figure, the spectrum envelope is not symmetrical with respect to the center frequency. This asymmetry is more pronounced at a higher data rate. This phenomenon comes from the band-flatness characteristics of the wideband IF components, such as the IF amplifiers, the BPF, and the DB-mixer used in our design. These characteristics may severely affect the communication performances, for example, increasing the BER. The DB-mixer used for ASK modulation is a GaAs SBD fundamental mixer (HMC 460, Hittite Corp., USA), where the conversion losses are 8 dB and 10 dB at frequency ranges of 24 GHz to 36 GHz and 36 GHz to 40 GHz, respectively.

To evaluate the demodulator performances, the ASK modulator is connected to the demodulator module through an attenuator. The input power levels of the designed demodulator are from -50 dBm to -30 dBm with an AGC range of 20 dB. The attenuation value is set to 32 dB and an average modulated power of -37 dBm is input in the demodulator, in which the average output power of the ASK modulator is measured to be -5 dBm , using an RF power meter. The measured eye diagrams are shown in Fig. 16 for data rates (Gbit/s) of 1.5, 3.0, 5, and 10.

With an increase in the data rates, the BERs also increase. In addition, an error detection (ED) measurement shows BERs of below an order of 10^{-10} up to 5 Gbit/s and no errors ($\text{BER} < 10^{-12}$) at 1.5 Gbit/s. At 10 Gbit/s, the eye diagram is completely closed, as shown in Fig. 16(d). This result accounts for some of the limitations of the BB and IF-band electronics in wideband and high-speed communications, possibly owing to the band-limited signals, band-flatness characteristics of the components

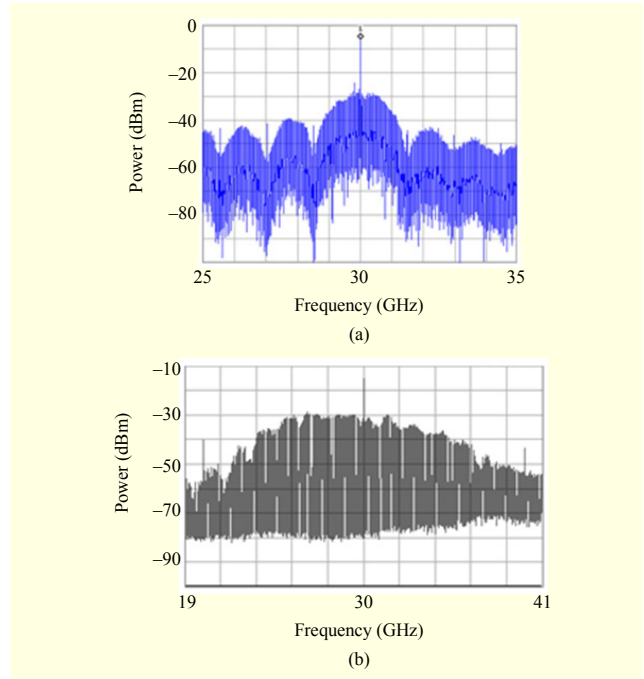

Fig. 15. 30-GHz ASK modulator output spectra for data rates of (a) 1.5 Gbit/s (RBW 3 MHz, VBW 3 MHz, Span 10 GHz) and (b) 10 Gbit/s (RBW 1 MHz, VBW 1 MHz, Span 22 GHz).

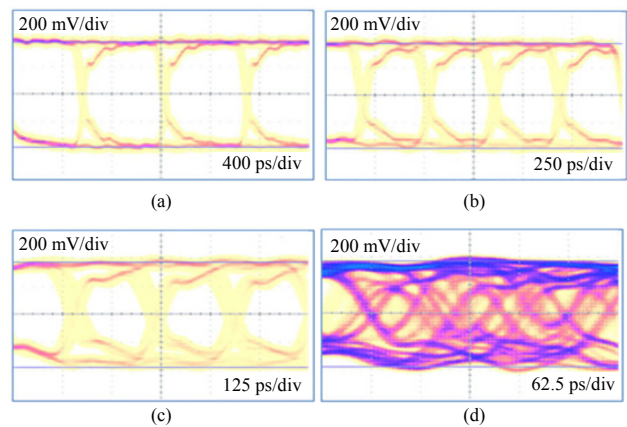

Fig. 16. Data transmission characteristics of 30-GHz ASK modulator and demodulator with direct connection to each other through attenuator; measured eye diagrams of receiver output without using CDR circuit at data rates (Gbit/s) of (a) 1.5, (b) 3.0, (c) 5.0, and (d) 10.

used, frequency-dependent losses in the signal paths, and so on. We use a CDR circuit with an equalizer to successfully recover the transmitted data in the receiver, which will be described in detail in section IV.

3. Measurement of Effective Antenna Gain

To roughly estimate the effective antenna gain using a lens,

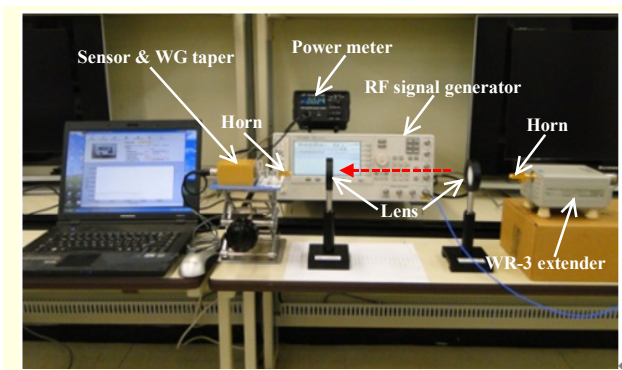

Fig. 17. Experimental setup used to measure effective antenna gain.

an RF signal generator with a WR-3 extender (model: S03MS, OML Inc.) operating at 220 GHz to 325 GHz is connected to a horn antenna at one side, and a power meter (PM 4, VDI) with a WR-3-to-WR-10 waveguide taper is connected to the other side, as shown in Fig. 17. The antenna is a diagonal horn (model: WR-2.8 Horn, VDI, USA) with a gain of 25 dB and a beamwidth of 10° . A high-density polyethylene lens (HDPE) is used for collimating the THz beam, with a focal length of 7.5 cm and a diameter of 5 cm.

From the link budget equation in (3), when increasing distance d tenfold, the received power P_{rx} is decreased by 20 dB. In this experiment, the same received power is measured by increasing distance d ninefold when using lenses, which gives a total effective antenna gain of $20\log(9) = 19$ dB, accounting for a gain increase of 9.5 dB per lens. This data is utilized to analyze the theoretical and experimental transmission ranges.

$$P_{rx} = P_{tx} + 2 \cdot G_{ant} - 10 \cdot \log\left(\frac{4\pi df}{c}\right)^2, \quad (3)$$

where d is the separation distance in meters between two horn antennas.

IV. 300 GHz Wireless Link

1. Link Setup

A compactly designed transmitter and receiver are installed on platforms with a mechanically adjustable height, as shown in Fig. 18, for a wireless link test at 300 GHz. In this setup, the incoherent ASK system is established without the use of external equipment for signal synchronization and by using only a data signal input to the transmitter as the signal source and a data signal output from the receiver for the measurements. As shown in the figure, the CDR circuit functions are externally implemented at the receiver output

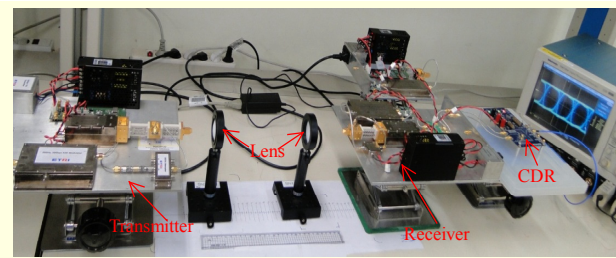

Fig. 18. 300-GHz wireless link test setup; transmitter (left), PE lenses (middle), receiver (right), and CDR circuit board in front of digital oscilloscope (far right).

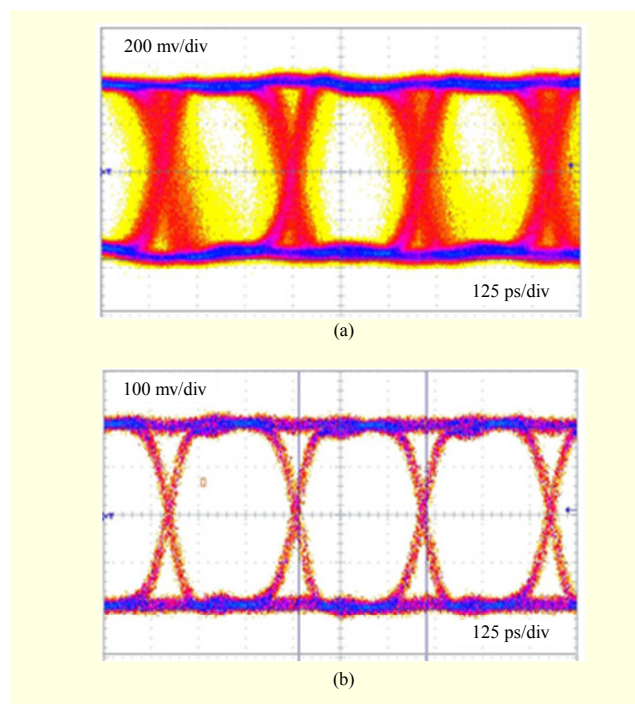

Fig. 19. Eye diagrams at data rate of 2.97 Gbit/s (a) before and (b) after CDR circuit.

using various commercial boards.

2. High-Definition Video Signal Transmission

A high-definition (HD) video signal transmission test is first performed using DVI-to-HDS DI (model: 3GSC-DS1, FureLink Inc.) and HDS DI-to-DVI (model: 3GSC-DS1, FureLink Inc.) converters, which support both the SMPTE292M (1.485 Gbit/s) and SMPTE424M (2.97 Gbit/s) standards. The video signal source is generated on a personal computer (PC), and a PC monitor or HDTV is used for the signal reception. The video signals at data rates of 1.485 Gbit/s and 2.97 Gbit/s are successfully transmitted over a distance of 1.2 m using lenses and displayed on an HDTV with resolutions of $1080p \times 720p$ (1.485 Gbit/s) and $1920p \times 1080p$ (2.97 Gbit/s).

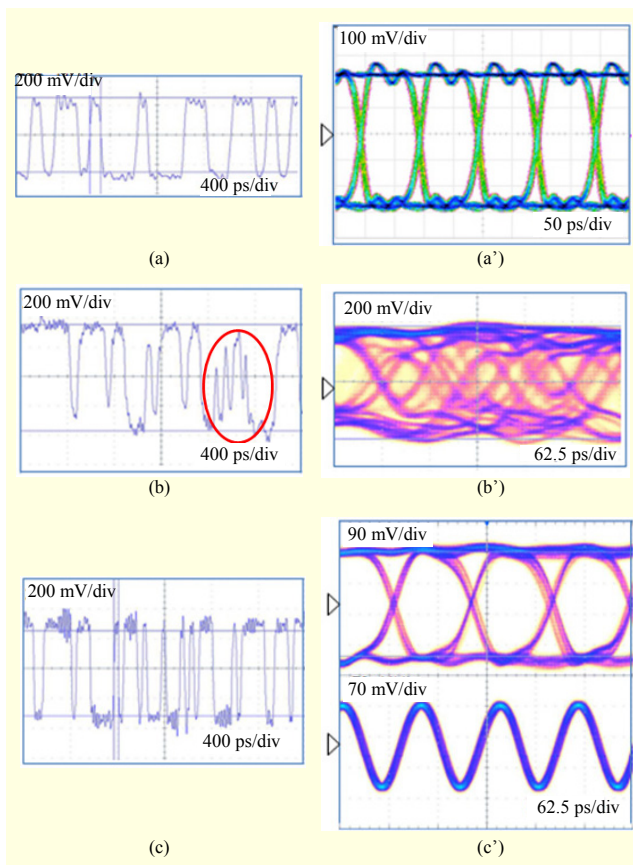

Fig. 20. 10-Gbit/s wireless transmission performance at 300 GHz; received data waveforms and eye diagrams at 10 Gbit/s: (a) and (a') PPG signals, (b) and (b') before CDR circuit/equalizer, and (c) and (c') after CDR circuit/equalizer (upper trace, data; lower trace, clock).

Although the eye diagrams show a relatively desirable quality of up to 3.0 Gbit/s, a lot of jitter occurs in the received signal, as shown in Fig. 19(a), which disables the HDTV display. After connecting the CDR circuit board (model: SD346EVK, National Semiconductor) to the receiver output, the received video signal with the better eye diagram, as shown in Fig. 19(b), successfully turns on the HDTV. This means an error-free transmission, in which the BER is on the order of 10^{-12} .

3. 10-Gbit/s Data Transmission

A wireless link test for a 10-Gbit/s data rate transmission is performed using a PPG as a signal source and a digital oscilloscope as a signal sink. In this experiment, we use a CDR circuit/equalizer board (Max3992EVKIT, Maxim Inc.) at the receiver output, as shown in Fig. 18. As described in section III, the completely closed eye diagram shows that it is very difficult to recover data and clock signals using only the CDR circuit function, and thus an equalization function is needed for preprocessing before the CDR circuit function [12]. A

nonreturn-to-zero (NRZ) signal with a 2^7-1 -PRBS used in this experiment has a wide range of frequency components. As this signal transmits through the circuit components, it experiences different attenuations depending on its frequency, more attenuated at a high frequency and less attenuated at a low frequency, which does not give rise to a constant amplitude in the NRZ signal levels. The equalizer is a kind of adaptive HPF that can compensate the NRZ signal levels in reverse actions so that it can remove most of the deterministic jitter signals caused by frequency-dependent losses.

The Max3992 chip supports both functions of CDR circuit and equalization in a single chip for data rates of 9.95 Gbit/s to 11.1 Gbit/s. A reference clock is needed for operating the chip with a 1/64 clock rate, which is implemented in our receiver hardware, at 155.52 MHz for the OC-192 standard (9.953 Gbit/s). The results of the 10-Gbit/s (9.953 Gbit/s to be precise) data transmission are shown in Fig. 20. In the figure, (a) and (a') indicate the transmitted signal waveform captured by the "single shot" mode in an oscilloscope and eye diagram, and (b) and (b') are the raw received data waveform and its eye diagram of the receiver output, respectively.

In Fig. 20(b), the NRZ signal marked with a circle does not show a flat-topped level, which makes the eye diagram completely closed. This signal is first applied to an equalizer block to flatten the level and then to a PLL block to recover the data and clock, where the two blocks above are provided in the CDR circuit/equalizer board used in the experiment. Figures 20(c) and 20(c') show the recovered data waveform and its eye diagram, respectively, which show an error-free BER on ED equipment over a distance of 1.2 m using lenses.

4. Discussion

The asymmetrical ASK modulated signal at a high IF of 30 GHz and the conversion loss variations of the SBD-based SHMs used adversely accumulate the band-flatness characteristic, which may affect the overall communication performances. The passband of the designed 270-GHz HPF is zoomed-out over operating frequencies of 290 GHz to 310 GHz for a 10-Gbit/s data transmission, as shown in Fig. 21. The flatness is about ± 0.6 dB with respect to a center frequency of 300 GHz. It is noted that the HPF may compensate for the RF passband, such that the left- and right-half spectra with respect to the center frequency are more or less attenuated.

The DSB transmission can also be achieved by removing the 270-GHz HPF in the proposed transceiver. In this case, Tx-LO and Rx-LO frequencies must differ by an IF, for example 10 GHz. Even though the two LOs perfectly matched each other in a coherent configuration, an image rejection problem occurs. In an incoherent configuration, the actual LOs in the

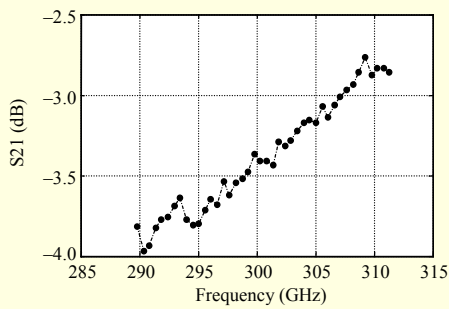

Fig. 21. Measured band-flatness characteristics of 270-GHz HPF (zoomed-out).

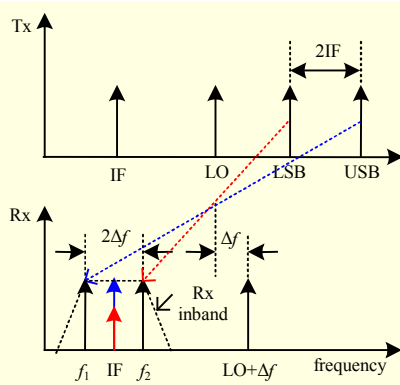

Fig. 22. Vector graph showing undesirable characteristics for DSB transmission with matched and mismatched LO frequencies.

transmitter and receiver, however, will show relative frequency accuracy because they are free running through the frequency multiplication in the LO chains. For example, as shown in Fig. 22, the transmitted LSB and USB signals are down-converted into f_2 and f_1 , respectively, $2\Delta f$ away from each other, when Tx-LO and Rx-LO frequencies differ by Δf , in an incoherent configuration. One of two inband signals, f_1 and f_2 , cannot be rejected by any IF filter in the receiver. On the other hand, for a coherent system, the transmitted LSB and USB signals are down-converted into the same IF in the receiver, but the signal amplitudes, shown as blue and red arrows, may differ owing to the different conversion loss of the SHMs at the LSB and USB frequencies. To reject the image signal, an HPF can also be utilized in front of the SHM of the receiver.

V. Conclusion

A single sideband and incoherent ASK transmitter and receiver with a high-IF heterodyne architecture utilizing a continuous bandwidth of 20 GHz were designed to demonstrate a wireless data transmission at 300 GHz. The system is error-free at up to 10 Gbit/s, with the aid of a CDR

circuit with an equalizer in the receiver output, which may be the maximum data rate achievable for this design. To the best of our knowledge, this is the first time a wireless data transmission of up to 10 Gbit/s has been demonstrated for this type of system. The experiment results show the feasibility of employing a high IF, which is very challenging in THz communication systems.

References

- [1] I. Kallfass et al., "All Active MMIC-Based Wireless Communication at 220 GHz," *IEEE Trans. THz Sci. Technol.*, vol. 1, no. 2, Nov. 2011, pp. 477-487.
- [2] M. Abbasi et al., "Single-Chip 220-GHz Active Heterodyne Receiver and Transmitter MMICs With On-Chip Integral Antenna," *IEEE Trans. Microw. Theory Techniques*, vol. 59, no. 2, Feb. 2011, pp. 466-478.
- [3] C. Jastrow et al., "Wireless Digital Data Transmission at 300 GHz," *Electron. Lett.*, vol. 46, no. 9, Apr. 2010, pp. 661-663.
- [4] H.J. Song et al., "Terahertz Wireless Communication Link at 300 GHz," *IEEE Topical Meeting Microw. Photonics (MWP)*, Oct. 2010, pp. 42-45.
- [5] H.J. Song et al., "8 Gbit/s Wireless Data Transmission at 250 GHz," *Electron. Lett.*, vol. 45, no. 22, Oct. 2009, pp. 1121-1122.
- [6] W.J. Byun et al., "40 GHz Vertical Transition with a Dual-Mode Cavity for a Low-Temperature Co-fired Ceramic Transceiver Module," *ETRI J.*, vol. 32, no. 2, Apr. 2010, pp. 195-203.
- [7] H.J. Song and T. Nagatsuma, "Present and Future Terahertz Communications," *IEEE Trans. THz Sci. Technol.*, vol. 1, no. 1, Sept. 2011, pp. 256-263.
- [8] T. Nagatsuma et al., "Giga-bit Wireless Link Using 300-400 GHz Bands," *IEEE Int. Topical Meeting Microw. Photonics (MWP)*, Th.2.3, Valencia, 2009, pp. 1-4.
- [9] J. Anthes, "OOK, ASK, and FSK Modulation in the Presence of an Interfering Signal," technical report, RF Monolithics, Inc., Dallas, TX, USA.
- [10] T.J. Chung and W.H. Lee, "A 1.485 Gbit/s Video Signal Transmission System at Carrier Frequencies of 240 GHz and 300 GHz," *ETRI J.*, vol. 33, no. 6, Dec. 2011, pp. 965-968.
- [11] C.L. Hsu, F.C. Hsu, and J.T. Kuo, "Microstrip Bandpass Filters for Ultra-Wideband (UWB) Wireless Communications," *IEEE MTT-S Int. Microw. Symp. Dig.*, June 2005, pp. 679-682.
- [12] J. Liu and X. Lin, "Equalization in High-Speed Communication Systems," *IEEE Circuits Syst. Mag.*, Second Quarter, vol. 4, no. 2, 2004, pp. 4-17.



Tae Jin Chung received his BS in electronics engineering from Chungnam National University, Daejeon, Rep. of Korea, in 1979 and his MS and PhD in electronics engineering from the Korea Advanced Institute of Science and Technology (KAIST), Daejeon, Rep. of Korea, in 1990 and 2004, respectively. From 1979 to 1983, he was with the Agency for Defense Development (ADD), Daejeon, Rep. of Korea. From 1983 to 1984, he was with Daewoo Heavy Industries co., Ltd. In 1984, he joined ETRI, Daejeon, Rep. of Korea, and works for the Radio Technology Research Department as a principal member of the research staff. His current research interests include microwave/millimeterwave RF/IF and system designs.



Won-Hui Lee received his MS and PhD in electronics and information communication engineering from Konkuk University, Seoul, Rep. of Korea, in 2000 and 2003, respectively. From 2002 to 2008, he was with the LG Electronics Digital Appliance Laboratory, Seoul, Rep. of Korea. From 2008 to 2009, his post-doctoral research was conducted at Pohang University of Science and Technology (POSTECH), GyeongBuk, Rep. of Korea. In 2009, he joined ETRI, Daejeon, Rep. of Korea, and works for the Radio Technology Research Department as a senior member of the research staff. His current research interests include microwave/millimeterwave system designs and Terahertz imaging.