

Motor Control of a Parallel Hybrid Electric Vehicle during Mode Change without an Integrated Starter Generator

Minseok Song*, Joseph Oh*, Seokhwan Choi*, Yeonho Kim**
and Hyunsoo Kim[†]

Abstract – In this paper, a motor control algorithm for performing a mode change without an integrated starter generator (ISG) is suggested for the automatic transmission-based hybrid electric vehicle (HEV). Dynamic models of the HEV powertrains such as engine, motor, and mode clutch are derived for the transient state during the mode change, and the HEV performance simulator is developed. Using the HEV performance bench tester, the characteristics of the mode clutch torque are measured and the motor torque required for the mode clutch synchronization is determined. Based on the dynamic models and the mode clutch torque, a motor torque control algorithm is presented for mode changes, and motor control without the ISG is investigated and compared with the existing ISG control.

Keywords: HEV, Motor control, Mode change

1. Introduction

Due to the rising energy prices caused by the depletion of crude oil and the restrictions on CO_2 emissions as a result of global warming, the development of high fuel economy and environment-friendly vehicles has become a priority in the automobile industry. In 2010, x-EVs such as electric vehicles (EVs) and hybrid electric vehicles (HEVs) began to replace the conventional internal combustion engine vehicles and are expected to account for 25% of the global vehicle market by 2030.

HEVs can improve fuel economy and reduce CO_2 emissions because they adopt motor power assists and regenerative braking. Furthermore, because HEVs do not require the installation of a separate electric charging facility, unlike battery-EVs, HEVs are expected to account for 16% of global vehicle production by 2020 [1].

Two main types of HEVs as passenger cars are the power-split-type and the parallel-type. Power-split-type HEVs, represented by Toyota Hybrid System (THS), has an electrical, continuously variable transmission with two motors and can separate the engine speed from the vehicle speed so that the engine can operate with the lowest fuel consumption, freed of on-off during travel in the EV mode. At high speeds, however, the THS generates energy recirculation and uses two big-capacity motors, which increase the load on the inverter and other power

electronics and make it difficult to lower the manufacturing cost of hybrid elements below a certain level.

Parallel-type HEVs have the advantage of allowing not only motor power assist but also EV mode driving by the motor and the use of existing transmission. Continuously variable transmission [2-3], dual-clutch transmission, and automatic transmission (AT) [4] have been adopted as transmissions for parallel-type HEVs. Unlike THS-based power-split-type HEVs, AT-based parallel-type HEVs would allow the use of the existing AT production line to greatly reduce the hybridization cost and the use of only one motor, which can provide a fuel economy level comparable to that of THS-based HEVs.

Fig. 1 shows the AT-based parallel-type HEV under study. The torque converter is removed, and a motor and a mode clutch are installed in its place. The engine and motor are separated by the mode clutch. The motor is connected to the transmission input shaft, and the HEV can be driven only by the motor at initial start and at a low speed (EV mode). In the HEV mode, the power from the engine and that from the motor are used together by

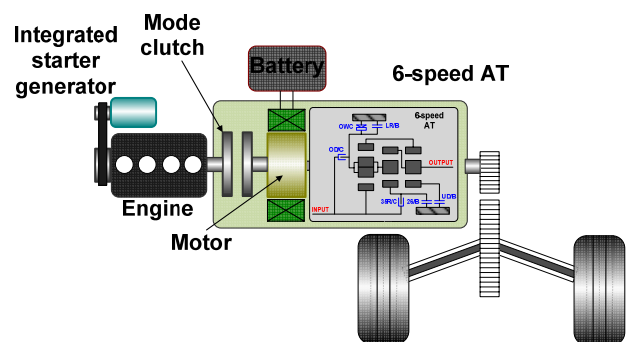

Fig. 1. AT-based parallel-type HEV structure

[†] Corresponding Author: School of Mechanical Engineering, Sungkyunkwan University, Korea. (hskim@me.skku.ac.kr)

* School of Mechanical Engineering, Sungkyunkwan University, Korea. (aneol23@skku.edu, josephdreamer5@gmail.com, choisky@nate.com)

** Hybrid Electric Vehicle Design Team, Hyundai-Kia R&D Center, Korea. (yeonokim@hyundai.com)

Received: May 27, 2013; Accepted: June 7, 2013

engaging the mode clutch.

When changing from the EV mode to the HEV mode, the HEV under study synchronizes its engine speed and motor speed using the integrated starter generator (ISG) and the mode clutch. At this moment, a sharp torque variation may occur due to the speed difference between both ends of the clutch, which would reduce driving comfort. In general, a torque shock occurs if the clutch is engaged when the speed difference between the clutch discs is large. If the clutch engagement time is increased until the speed difference between both ends of the clutch becomes small enough, the torque shock can be reduced, but increasing of clutch engagement time would increase the slip between the clutch discs, which in turn would delay vehicle acceleration and lead to heat generation. Therefore, an appropriate control of the mode clutch is required with consideration of driving comfort, acceleration performance and clutch slip. In this regard, many studies have been performed on the drag torque of the judder and the stick-slip during clutch engagement [5-6], and experimental investigations have been carried out on clutch modeling considering clutch speed and clutch pressure [7]. As for the mode-change control algorithm, the closed-loop and open-loop hydraulic control methods have been suggested for clutch slip control according to the transmission input shaft speed to improve vehicle performance and driving comfort [8]. A study on switched causal modeling of the mode clutch lock up condition was investigated [9]. In dual-drive full HEVs, the mode change process from the electric mode to the parallel-split mode is divided into four major control phases, and the vehicle behavior in a transition state was analyzed with control strategies [10]. In [11], an EV-to-HEV mode change strategy was suggested for the parallel-type HEV.

The ISG of the HEV under study (Fig. 1) is connected to the engine through a belt drive. The typical role of the ISG is to increase the engine speed to the target speed when the vehicle is restarted from an idle stop. In an HEV using the ISG, the engine is turned off when the vehicle is in the idle stop, cutting off fuel supply, and as a result, the vehicle's fuel economy is improved. Due to this advantage, a 42-volt ISG vehicle and a mild-hybrid EV, which are conventional vehicles with the addition of ISGs, have been developed and commercialized [12-13]. In the HEV under study, the ISG generates a torque during a mode change to increase the engine speed from zero until it is synchronized to the motor speed and changes modes by engaging the mode clutch. In the motor-engine speed synchronization process, the engine turns on when the target speed is reached, and when the mode clutch is engaged, the vehicle is propelled by both the engine and the motor.

The ISG and its relevant parts, however, including the inverter, have additional costs and require extra space for installation. The ISG also causes noise and vibration problems due to its high operation speed. The HEV under study can solve the aforementioned problems if it can

change modes by controlling the driving motor torque instead of using the ISG.

This paper presents a motor control algorithm for a mode change with the motor only, with elimination of the ISG from the AT-based parallel HEV. The dynamics equations of the engine, motor, and mode clutch during a mode change are derived, and the motor torque required for a mode change is measured using the HEV performance bench tester. Based on the mode change torque, a motor control algorithm for a mode change is proposed and verified.

2. Motor Control Algorithm for Performing Mode Change without an ISG

The motor and engine of the HEV under study are connected by the mode clutch. Thus, if the motor can be properly controlled, the engine speed can be controlled and a mode change can be executed using a mode clutch slip, even without an ISG. In this case, however, acceleration may be delayed if the mode change time is too long, and a torque shock may occur if it is too short. To address this problem, the dynamic characteristics of the motor, engine, and mode clutch must be considered.

In this study, a motor control algorithm is proposed for a mode change in an HEV without an ISG. To derive the motor control algorithm for a mode change, the following needs to be analyzed:

- 1) vehicle dynamics during a mode change
- 2) motor torque required for mode clutch synchronization during a mode change.

2.1 Vehicle dynamics during mode change

Fig. 2 shows the power flows of the ISG control (the existing control method) and the motor control without an ISG, as proposed in this study. Because the speed synchronization of both ends of the mode clutch is performed by the ISG under the ISG control while the mode clutch is disengaged, the characteristics of the mode

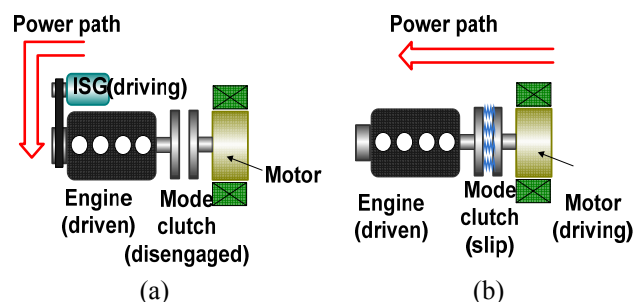

Fig. 2. Synchronization of the mode clutch via: (a) ISG control and (b) motor control without an ISG during mode change

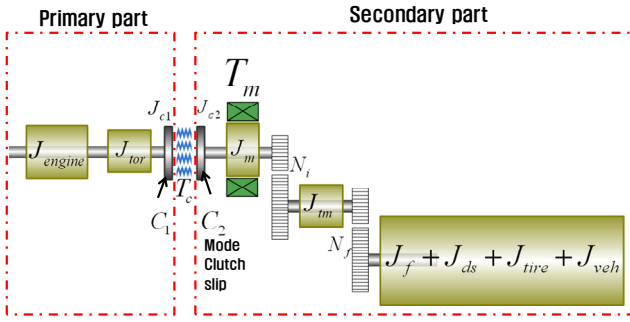

Fig. 3. Primary part and secondary part

clutch need not be considered during a mode change. However, in the motor control without an ISG, the speed synchronization is performed only by the torque transmitted from the motor through the mode clutch. Therefore, when the mode is changed under the motor control, the motor must be controlled by considering the torque required for the mode change, in addition to the torque required for vehicle driving.

The HEV powertrain under study, as shown in Fig. 3, can be divided into the primary part, which consists of the engine and the torsion damper, and the secondary part, which consists of the motor and the transmission .

Primary part: The primary part consists of the engine, torsion damper, and mode clutch disc C_1 . The equivalent inertia, J_{pr_eq} , of the primary part can be expressed as follows:

$$J_{pr_eq} = J_{c1} + J_{engine} + J_{tor} \quad (1)$$

where J_{c1} is the inertia of the clutch disc C_1 , J_{engine} the engine inertia, and J_{tor} the torsion damper inertia.

Secondary part: The secondary part consists of the mode clutch disc C_2 , the motor, the transmission, the final reduction gear, the driveshaft, the tire, and the vehicle. Considering the gear ratio and the final reduction ratio of the transmission, the equivalent inertia J_{sec_eq} of the secondary part can be expressed as follows:

$$J_{sec_eq} = J_{c2} + J_m + \frac{J_{tm}}{N_i^2} + \frac{J_f + J_{ds} + J_{tire} + m_{veh}r_{tire}^2}{N_i^2 N_f^2} \quad (2)$$

where J_{c2} is the inertia of the mode clutch disc C_2 , J_m the motor inertia, J_f the final reduction gear inertia, J_{ds} the driveshaft inertia, J_{tire} the tire inertia, m_{veh} the vehicle mass, r_{tire} the tire radius, N_i the transmission gear ratio, and N_f the final reduction gear ratio.

Motor torque control algorithm: Because the engine is off when the vehicle is running in the EV mode, the primary part is stationary and the secondary part rotates according to the vehicle speed. Therefore, during an EV-to-HEV mode change, the motor must generate an additional torque for the mode clutch synchronization besides the

torque required for vehicle driving. This mode clutch torque is used to synchronize the engine (mode clutch C_1) speed to the speed of the secondary part (mode clutch C_2) through the mode clutch. In this case, the smaller the speed difference between the mode clutch discs, the smaller the torque shock during mode clutch engagement and more the driving comfort. The dynamic equation of the primary part based on torque T_c that acts on the mode clutch is as follows:

$$T_c = J_{pr_eq} \dot{\omega}_e + b_{pr} \omega_e \quad (3)$$

where T_c is the mode clutch torque, ω_e the primary part (i.e, the engine) speed, and b_{pr} the coefficient of viscous friction. The dynamic equation of the secondary part during a mode change can be expressed as follows:

$$T_m - T_c = T_{veh} = J_{sec_eq} \dot{\omega}_m + b_{sec} \omega_m + \frac{T_L}{N_i N_f} \quad (4)$$

where T_m is the motor torque, T_{veh} the vehicle driving torque, ω_m the secondary part (i.e, the motor) speed, and b_{sec} the coefficient of viscous friction. The road load T_L is expressed as follows:

$$T_L = r_{tire} \cdot (f_r m_{veh} g \cos \theta + \frac{1}{2} \rho C_d A V^2 + m_{veh} g \sin \theta) \quad (5)$$

where T_L is the road load, f_r the rolling resistance coefficient, ρ the air density, C_d the drag coefficient, A the frontal area, and V the vehicle velocity.

The motor must be driven with torque that is the sum of the torque required for the mode change T_c and the torque required for vehicle driving, T_{veh} . The motor torque T_m is expressed as follows:

$$T_m = T_c + T_{veh} \quad (6)$$

Fig. 4 shows the block diagram of the motor torque control during a mode change. The speed synchronization point during the mode change can be determined through the primary and secondary dynamic Eqs. (3) and (4). The speed synchronization is considered to be completed

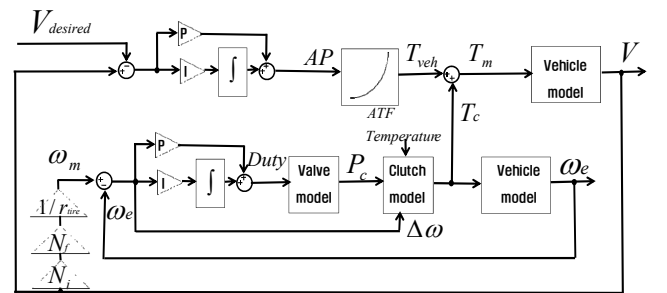

Fig. 4. Motor torque control algorithm during mode change

(synchronization point) when the speed difference, $\Delta\omega = |\omega_m - \omega_e|$, between the motor and engine is smaller than a set value. An additional torque, T_c , is generated only during clutch speed synchronization. After that, the motor generates only T_{veh} ($T_m = T_{veh}$).

2.2 Motor torque required for mode clutch synchronization during mode change

As mentioned in Section 2.1, the motor must additionally generate the torque required for the synchronization of the mode clutch during a mode change under motor control without an ISG.

The mode clutch of the HEV under study transmits torque through the friction between plates, which is generated when hydraulic pressure is applied through a wet-type clutch (Fig. 5). The mode clutch torque T_c depends on the clutch pressure and is expressed as follows:

$$T_c = \mu(\pi(R_{op}^2 - R_{ip}^2) \cdot P_c - F_s) \cdot n \cdot \frac{2(R_o^3 - R_i^3)}{3(R_o^2 - R_i^2)} + C_v \cdot \frac{n \cdot \pi \cdot \mu \cdot \nu}{2 \cdot plcl} \cdot \Delta\omega(R_o^4 - R_i^4) \quad (7)$$

where T_c is the mode clutch torque, μ the clutch friction coefficient, R_{op} the outside diameter of the clutch piston, R_{ip} the inside diameter of the piston, R_o the outside diameter of the clutch plate, R_i the inside diameter of the clutch plate, P_c the clutch pressure, F_s the static force of the return spring, $plcl$ the plate clearance, $\Delta\omega$ the speed difference (clutch slip speed) between the plates, C_v the viscous friction coefficient, ν the automatic transmission fluid (ATF) viscosity, and n the number of clutch plates. The first term on the right side of Equation (7) represents the transfer torque by the clutch pressure, and the second term, the transfer torque due to the viscosity of the ATF. Because the viscosity ν of the ATF decreases as the temperature increases, the transfer torque due to the viscosity must be determined experimentally.

To obtain the mode clutch torque characteristics, an

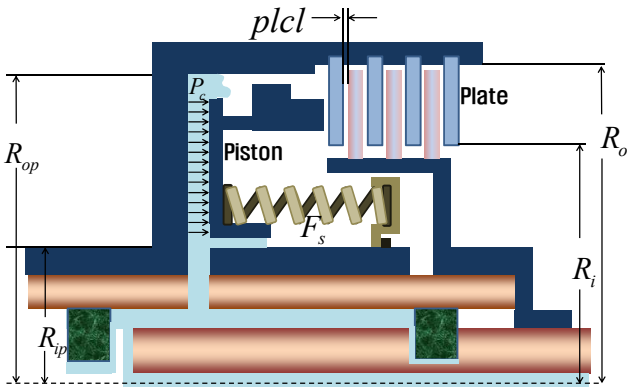

Fig. 5. Structure of the wet-type clutch

HEV performance bench tester was developed. Fig. 6 shows the structure of HEV performance bench tester. It consists of a motor that simulates the engine, a dynamo motor for simulation of the vehicle load, a 6 speed AT that includes a motor and a mode clutch, a temperature chamber for temperature control of the ATF, and a chamber controller. The motor that simulates the engine is controlled by an inverter. The inverter and the motor (engine simulator) were connected with a three-phase EMI filter to minimize the signal noise during data acquisition [14]. The AT input torque and the driveshaft torque are measured with a torque sensor, and the clutch pressure is measured with a pressure sensor. The AT was installed inside the chamber to obtain the mode clutch characteristics according to the ATF temperature, and the chamber temperature can be adjusted between -50 and 150°C.

The mode clutch pressure, the speed difference between the both ends of the clutch, and the mode clutch torque according to the ATF temperature were measured. The speed difference between both ends of the clutch, the mode clutch pressure, and the clutch torque were measured while the AT input shaft speed was kept constant and the pressure of the mode clutch was slowly increased.

Fig. 7 shows the mode clutch torque test results at the ATF temperature of 0°C. The clutch does not transmit torque until the clutch pressure force exceeds the spring

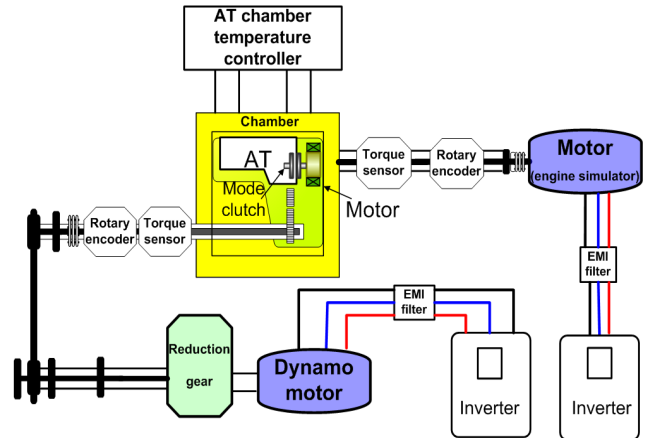

Fig. 6. HEV performance test bench

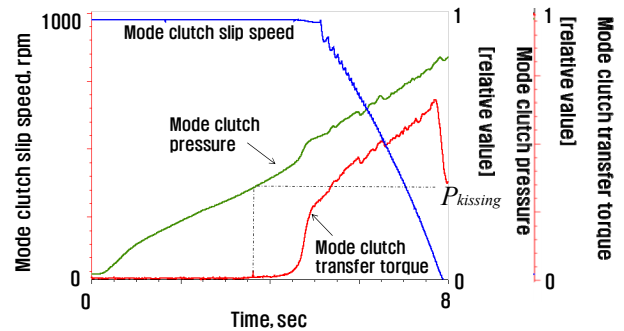

Fig. 7. Clutch transfer torque experiment

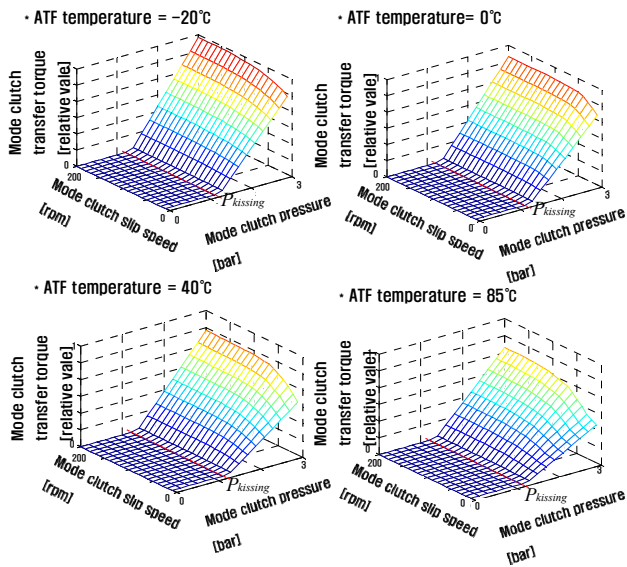

Fig. 8. Clutch transfer torque for the ATF temperature and the clutch slip speed

reaction force F_s . The point at which the clutch begins to transmit the torque is called the kissing point pressure. The mode clutch does not transmit the torque until the kissing point pressure, $P_{kissing}$, is reached. When the clutch pressure P_c is greater than $P_{kissing}$, the clutch torque increases in proportion to P_c . Before the torque was transmitted ($P_c < P_{kissing}$), the speed difference between both ends of the clutch remained at 1,000 rpm, which was the initial test condition, but the speed difference decreased as the clutch pressure increased.

Similar experiments were performed at ATF temperatures of -20°C , 40°C , and 85°C to measure corresponding clutch torques. Maps of the clutch torque according to the ATF temperature, the speed difference between both ends of the clutch, and P_c were obtained as shown in Fig. 8. As the ATF temperature increased, the viscosity of the ATF decreased, and the mode clutch torque decreased as a result.

3. Development of the HEV Performance Simulator

To verify the mode change performance using the motor control without an ISG, a target HEV powertrain model was obtained, and an HEV performance simulator was developed.

3.1 Modeling of the HEV powertrain

Motor: The motor drives the vehicle by receiving voltage and current from the battery and also acts a generator when charging the battery. The motor was modeled with a characteristic curve and an efficiency map. The motor

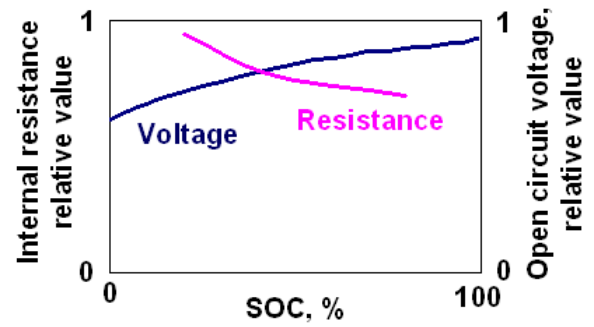

Fig. 9. Battery characteristics map

torque was modeled as a first-order system, considering the time constant of an actual output torque response.

Battery: The input and output currents of the battery were calculated using an internal resistance model. For the internal resistance of the battery, the experimental values of the battery state of charge (SOC) were used. Fig. 9 shows the characteristic curves of the battery’s internal resistance and the open-circuit voltage that were used in this study.

Engine: The engine was modeled using the engine characteristic map for steady state operation. The engine output torque was modeled as a first-order system.

6 speed-AT: The 6 speed AT under study consisted of two single-pinion planetary gears, one double-pinion planetary gear, two wet-type clutches, three wet-type brakes, and a one-way clutch.

The HEV powertrain was modeled using the AMESim software. Table 1 shows the HEV powertrain specifications and the AMESim model that was developed in this study.

Table 1. HEV powertrain specifications and AMESim models

	Specifications	AMESim Models
Motor	Max torque :205Nm at base speed Power: 30kw	
Battery	Li-polymer Nominal voltage : 270V Capacity: 5.25Ah	
Engine	Power: 113kw at 6000rpm	
Mode clutch	Maximum torque : 200Nm	
6 speed-AT	Final gear ratio: 3.32 Gear ratio 1 st : 4.21 2 nd : 2.84 3 rd : 1.84 4 th : 1.39 5 th : 1 6 th : 0.77	

3.2 HEV performance simulator

A performance simulator was developed based on the dynamic models of the powertrain of the HEV (Fig. 10).

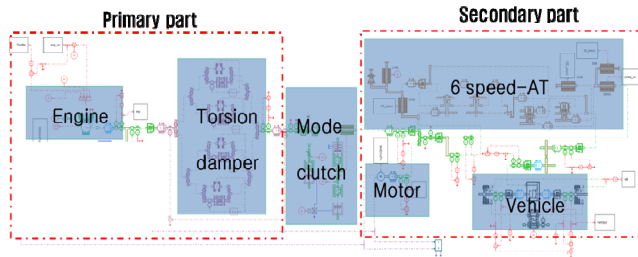

Fig. 10. HEV performance simulator

4. Mode Change Performance via Motor Control

Fig. 11 shows the (a) engine and motor speeds, (b) engine, motor, and ISG torques, (c) mode clutch pressure, and (d) driveshaft torque during a mode change for the motor control without an ISG and for the existing ISG control. The performance of the motor control without an ISG was investigated by simulation using the HEV performance simulator, and compared with that of the ISG control based on the test results of the HEV under study.

Motor control without an ISG: In Region A, the HEV runs in the EV mode. In the EV mode, the vehicle is propelled only by the motor, and the mode clutch is disengaged. Since the primary and secondary parts are disconnected, the engine is not running ($\omega_e = 0$).

Due to the intention of the driver to accelerate, the vehicle driving mode begins changing from the EV mode at the beginning of Region B. For the EV-to-HEV mode change, the primary part (engine) speed ω_e and the secondary part (motor) speed ω_m must be synchronized. Because the engine speed is zero, it must be increased by the motor torque until it reaches the motor speed (B). To transmit the motor torque through the mode clutch, a clutch pressure higher than $P_{kissing}$ is applied and consequently, the mode clutch is slipped. Using the mode clutch torque map (Fig. 8), the motor torque required for the mode clutch speed synchronization (T_c) according to the changing clutch pressure is added to the vehicle drive torque (T_{veh}). The engine speed increases by the mode clutch torque T_c and becomes identical to the motor speed. From Fig. 11a, it is found that the synchronization of the engine and motor speeds takes 0.55 sec.

When the clutch speed is synchronized by the motor control (Region B), the mode clutch pressure rapidly increases to lock up the clutch. As T_c is not needed once the speed synchronization is completed, the motor outputs only the torque for vehicle driving (Region C, point q). In Region C, after the lock up of the mode clutch, the vehicle

runs in the HEV mode with both the engine and the motor.

When the vehicle is running in the HEV mode, the engine and motor torques are distributed according to the HEV driving strategy. The engine-motor torque distribution is generally determined by considering energy efficiency, state of charge of the battery, etc. However, since driving comfort is given higher priority during a mode change, the input torque q in the EV mode (engine torque $p = 0$) needs to be maintained even after the vehicle changes to the HEV mode. Therefore, the motor torque must be controlled in such a way that after the engine is turned on, the sum of the engine torque r and the motor torque s becomes equal to the motor torque before the mode change q , in other words, $r + s = q$. When the HEV mode starts (Region D), it is controlled in such a way that the motor torque s has a negative value so that $r + s = q$, because the engine torque r due to the accelerator pedal of the driver is greater than q .

Region C is a transient state where the engine and motor torques become $p \rightarrow r$ and $q \rightarrow s$, respectively. This region was set at 1.4 sec by considering the smooth transition of the engine and motor torques.

ISG control (existing control): The ISG generates a torque to increase the speed of the engine (the primary part) during a mode change (Region B). Although the ISG torque (Fig. 11b) is smaller than the motor torque generated by motor control without an ISG, the ISG shaft and the engine shaft are connected through a belt with a pitch radius ratio of 1:2.5, so the torque that is actually applied to the engine (the primary part) is 2.5 times of the ISG torque. The speed synchronization time by the ISG control is 0.53 sec.

In Region B, the clutch pressure P_c is supplied, but it does not contribute to the clutch speed synchronization because it is smaller than the kissing point pressure $P_{kissing}$ (Fig. 11c). Here, P_c is used to increase the pressure response speed when the pressure is increased for the clutch lock up after the synchronization is completed.

When the speed at both ends of the clutch becomes identical by the ISG, the clutch pressure is rapidly increased to lock up the clutch and transmit the engine torque (Region C). In Regions C and D, the same control as the motor control without an ISG is applied.

The engine-motor speed synchronization times by the motor control without an ISG and by the existing ISG control are 0.55 sec and 0.53 sec, respectively, which are similar. With the motor control without an ISG, the peak-to-peak of the drive shaft torque is 55 Nm, and that with the ISG control is 32 Nm. When converted to the driveshaft acceleration, they are 0.005 g and 0.003 g, respectively. The peak-to-peak of the driveshaft acceleration by the motor control without an ISG is a little bit higher than that by the ISG control, but both values are much smaller than 0.08 g, which is the acceptable variation range of the driveshaft acceleration, so the accelerations from both controls do not affect the driving comfort. The

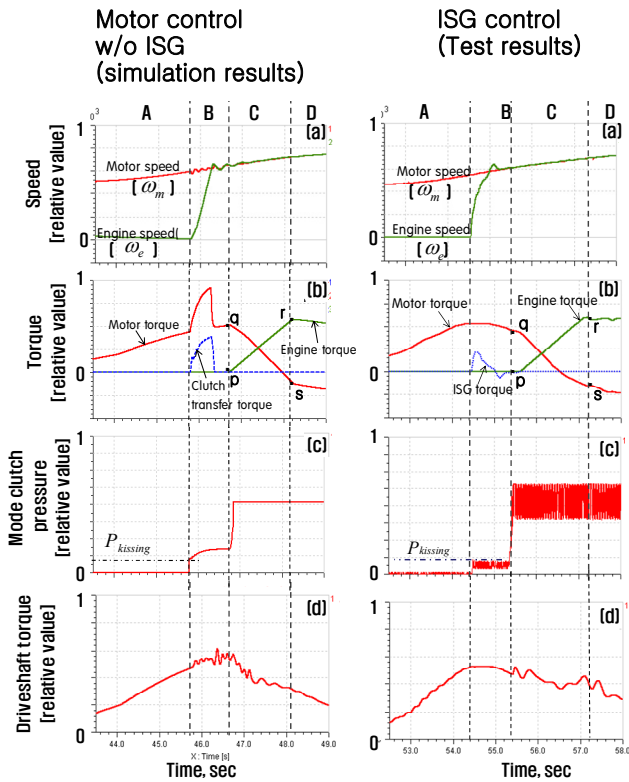

Fig. 11. Mode change performance simulations

simulation results showed that the clutch speed synchronization time by the motor control without an ISG was similar to that of ISG control, and both controls showed small driveshaft torque shocks within the acceptable range. These results verified that the motor control without an ISG proposed in this study is able to provide performance similar to that of the ISG control, even without an ISG.

5. Conclusion

A motor control algorithm for performing a mode change without the ISG was proposed for automatic transmission-based HEV. First, the dynamic models of the HEV powertrain during a mode change were derived and the HEV performance simulator was developed.

Using an HEV performance bench tester, the mode clutch torque was measured and the motor torque during the mode change was determined. Based on the mode clutch synchronization torque, a motor torque control algorithm without an ISG was presented

To verify the mode change performance by the motor control without the ISG, simulations were performed and compared with the test results for the mode change with the existing ISG control. From the simulation, it was found that the required time for the mode change was 0.55 sec for the motor control without ISG, similar to the 0.53 sec for the existing ISG control. Furthermore, the driveshaft accelerations of both controls were 0.005 g and 0.003 g,

respectively, which are much smaller than 0.08 g, the acceptable variation range of driveshaft acceleration. These results verified that the motor control without an ISG, which was proposed in this study, is able to provide performance similar to that of the existing ISG control during a mode change.

Acknowledgments

This work was supported by the Technology Innovation Program funded by the Ministry of Knowledge Economy (MKE, Korea), and the Korea Institute for Advancement in Technology through the Workforce Development Program in Strategic Technology.

References

- [1] The Boston Consulting Group “The come back of the electric car, how real, how soon, and what must happen next”, *BCG report*, 2009.
- [2] N. Hattori et al., “Functional design of motor integrated CVT for a parallel HEV”, *SAE paper* 1999-01-0753, 1999.
- [3] M. Hattori et al., “Development of metal belt-type continuously variable transmission for 150Nm Application”, *JSAE* Vol. 35, No. 2, 2004
- [4] K. Hanada et al., “Development of a hybrid system for the V6 midsize sedan 2005”, *SAE paper* 2005-01-0274, 2005.
- [5] A. Crowther et al., “Analysis and simulation of clutch engagement judder and stick-slip in automotive powertrain systems” *Proc. IMechE, Part D: J. Automobile Engineering*, Vol. 218, No. 12, 1427-1446, 2004
- [6] Y. Yuan et al., “An improved hydrodynamic model for open wet transmission clutches”, *J. Fluids Eng. Vol. 129 / Issue 3, TECHNICAL PAPERS*, 2007
- [7] J. Deur et al., “Modeling of wet clutch engagement including a thorough experimental validation”, *SAE paper* 2005-01-0877, 2005.
- [8] S. Kim et al., “A study on control strategy for hybrid electric vehicle during mode change”, *KSAE 2008 Annual Conference*, 2008
- [9] W. Lhomme et al., “Switched causal modeling of transmission with clutch in hybrid electric vehicles” *IEEE Transactions on Vehicular Technology*, Vol.57, No.4, July 2008
- [10] I. Soliman et al., “Control of electric to parallel hybrid drive transition in a dual-drive hybrid powertrain”, *SAE paper* 2010-01-0819, 2010.
- [11] H. Jung et al., “Control strategy development for belt-driven ISG(integrated starter generator) system applied to the parallel hybrid vehicle”, *KSAE 2007 symposium*. 24-36, 2007
- [12] J. Kim et al., “Development of 42-volt ISG vehicle

drive strategy and simulator” *KSAE 2004 annual conference*, 2004

- [13] F. Renken et al., “Power electronics for hybrid-drive systems” *Power Electronics and Applications, 2007 European Conference*
- [14] M. Simic et al., “Development of a data acquisition system for the testing and verification of electrical power quality meters” *Journal of Power Electronics*, Vol. 12, No. 5, 2012



Minseok Song He received B.S and M.S in mechanical engineering from Sungkyunkwan University, Suwon, Korea, in 2009 and 2011, where he has been working toward Ph. D. degree. His research interests include modeling and control of powertrain system for hybrid electric vehicle and plug-in hybrid

electric vehicle.



Joseph Oh He received B.S and M.S in mechanical engineering from Sungkyunkwan University, Suwon, Korea, in 2011 and 2013. His research interests include modeling powertrain system for hybrid electric vehicle.



Seokhwan Choi He received B.S in mechanical engineering from Sungkyunkwan University, Suwon, Korea, in 2012 where he has been working toward M.S. degree. His research interests include modeling powertrain system for hybrid electric vehicle.



Yeonho Kim He received B.S., M.S. and Ph.D. degrees in mechanical engineering from Sungkyunkwan University, Suwon, Korea, in 1991, 1993 and 2012. Since 1993, he has worked in automotive transmission division and he is responsible for developing hybrid transmission at HEV system engineering

team in Hyundai Motor Company.



Hyunsoo Kim He received a B.S. in mechanical engineering from Seoul National University, Seoul, Korea, in 1977, a M.S. degree in mechanical engineering from the Korea Advanced Institute of Science and Technology (KAIST), Seoul, Korea, in 1979, and a Ph.D. degree in mechanical engineering

from the University of Texas at Austin, Texas, USA, in 1986. Since 1986, he has worked as a Professor, Chairman, and Dean of the College of Engineering at Sungkyunkwan University. His main research interests include Hybrid Electric Vehicle (HEV) transmission system design, regenerative braking, and optimal power-distribution algorithms for HEV and vehicle stability control for HEV and In-wheel Electric Vehicles. He has authored numerous journal papers and patents. Prof. Kim served as a President of Electric Drive Vehicle Division of the Korea Society of Automotive Engineers and an editor of the International Journal of Automotive Technology from 2005 to 2012. He has served the society as a leader in next-generation automotive technology in Korea. He was the recipient of the “Best Paper Award 2001” from the Korea Science and Technology Foundation and the “Baekam Award for Excellent Paper” from the Korea Society of Mechanical Engineers in 1991.