

The Welding Surface and Mechanical Characteristics in Friction Stir Welding for 5456-H116 Alloy

Seong-Jong Kim* · Min-Su Han**† · Seok-Ki Jang**

*, ** Faculty of Marine Engineering, Mokpo Maritime University, Jeonnam, 530-729, Korea

마찰교반용접에 의한 5456-H116 합금의 용접 형상과 기계적 특성

김성종* · 한민수**† · 장석기**

*, ** 목포해양대학교 기관시스템공학부

Abstract : The use of Al alloys instead of fiber-reinforced plastic(FRP) in ship construction has increased because of the advantages of Al-alloy ships, including high speed, increased load capacity, and ease of recycling. This paper describes the effects of probe diameter on the optimum friction stir welding conditions of 5456-H116 alloy for leisure ship, measured by a tensile test. In friction stir welding using a probe diameter of 5mm under various travel and rotation speed conditions, the best performance was achieved with a travel speed of 61 mm/min. Using a probe diameter of 6mm, rotation speeds of 170 - 210 rpm, and a travel speed of 15mm/min produced a rough surface and voids because of insufficient heat input produced by the low rotation speed. At 500 - 800 rpm, chips were observed, although there were no voids, and the weld surface was excellent. However, at 1100 - 2500 rpm, many chips were produced due to excessive heat input. Heat effects were very evident on the bottom. For a travel speed of 15 mm/min, heat input caused by friction increased as the rotation speed increased. The mechanical characteristics were degraded by accelerated softening due to increasing heat input.

Key Words : Al alloy ships, Friction stir welding, Tensile test, Rotation speed, Mechanical characteristics

요 약 : 선박 구조재료 FRP 재료의 대체 재료로 빠른 선속과 선적량 증가는 물론 재활용이 용이한 Al 선박으로 전환되고 있다. 본 논문에서는 인장실험을 통해 레저선박에 사용되는 5456-H116 합금에 대한 최적의 마찰교반용접 조건에서 프루브 직경의 효과를 기술하였다. 마찰교반용접에서 이송속도, 회전속도를 변수로 5mm의 프루브 직경을 사용하여, 이송속도가 61 mm/min의 조건에서 가장 우수한 결과를 나타냈다. 프루브 직경 6mm, 회전속도 170 - 210 rpm, 이송속도 15 mm/min에서는 낮은 회전속도로 인하여 불충분한 용접열이 발생하여 거친 표면과 기공이 형성되었다. 회전속도 500 - 800 rpm인 경우, 용접부에 칩이 관찰되었으며, 기공은 생기지 않았고, 용접표면은 우수하였으나 1100 - 2500 rpm에서는 지나친 용접열의 발생으로 많은 칩이 발생하였다. 열에 의한 영향은 용접 배면에서 관찰되었다. 이송속도가 15 mm/min에서 회전속도의 증가하게 되면 마찰이 증가함에 따라 용접열이 발생한다. 기계적 특성은 용접 입열량이 증가할수록 재질의 연화가 가속화되어 저하하였다.

핵심용어 : Al 선박, 마찰교반용접, 인장시험, 회전속도, 기계적 특성

1. Introduction

Friction stir welding was developed at The Welding Institute in the UK in 1991. It is a solid welding technique that efficiently uses friction produced by a rotating tool and plastic flow produced by welding materials. The material to be welded is positioned firmly, as in the butt-welding of plate material in train, aircraft, automobiles, vessels, semiconductors, and building construction. In these applications, butt welding is considered the optimum method

of welding plate materials(Tanabe and Matsumoto, 2001).

There is increasing interest in Al alloys as a material to reduce the environmental load in various applications. Al alloy has many advantages such as light weight, recycling suitability, miniaturization capability, and environmental resistance(SKY Al Products Corporation, 2003). Fiber-Reinforced Plastic(FRP), which is often used in small fishing boats, has major disadvantages. It is not environmentally friendly, as it is impossible to recycle, and there is no way of repairing damaged hulls. Furthermore, the small radar cross section of FRP boats makes them difficult to detect, and this leads to a large number of collisions(Kang and Cho, 2004). Al offers numerous advantages over FRP, such

* First author : ksj@mmu.ac.kr, 061-240-7226

† Corresponding author : mp949@mmu.ac.kr, 061-240-7230

as increased power-to-weight ratios, greater capacity, and reduced labor cost. More importantly, Al-alloy hulls can be easily recycled. In general, the corrosion in Al and its alloy occurs through crevice corrosion of galvanic corrosion (Son et al., 2007; Sakairi et al., 2008; Yoon et al., 2006; Kim et al., 2007; Huang, 2002). Previous electrochemical research has shown that in marine environments the 5000 series of Al alloys is better than the 1000 or 7000 series from the perspective of stress-corrosion cracking and hydrogen brittleness. The optimum corrosion protection potential for 5456-H116 has been determined by slow-strain-rate testing and fractography analysis at various potentials (Kim, 2006; Kim et al., 2006). In addition, various welding technologies for 5000 series specimens have been developed, and the optimum welding technology, and electrochemical characteristics for use in seawater have been investigated (Kim et al., 2007; Kim, 2007; Kim and Kim, 2007).

This paper describes on welding surface and mechanical characteristics with the factors of rotation speed and travel speed in friction stir welding for 5456-H116.

2. Material and experimental

The Al-Mg alloy examined in this study is used for vessels and offshore structures. It has good weldability, anti-corrosion properties, and high strength. Table 1 shows the chemical composition and mechanical characteristics of 5456-H116 Al alloy. The tests to determine the optimum welding conditions used a shoulder diameter of 20 Φ , probe length pressurizing depth of 4.5 mm, pitch of 1.0 mm, and probe advance angle of 2°. The full-screw type probe rotated counterclockwise. Probe diameters of 5 and 6 mm were selected as a function of the rotation and travel speeds. Table 2 shows the probe dimensions and welding conditions for friction stir welding of 5456-H116. The strain rate in the tensile test was 0.2 mm/min. Figure 1 presents schematic diagram of tensile test specimen for evaluation with various friction-stir-welding conditions.

Table 1. Comparison of mechanical properties and chemical composition for 5456-H116

| Mechanical property | Tensile Strength (MPa) | | | Yield Strength (MPa) | | | Elongation (%) | | |
|----------------------|------------------------|------|------|----------------------|------|------|----------------|------|------|
| | 534.1 | | | 397.9 | | | 14 | | |
| Chemical composition | Si | Fe | Cu | Mn | Mg | Cr | Zn | Ti | Al |
| | 0.08 | 0.20 | 0.05 | 0.79 | 4.80 | 0.09 | 0.09 | 0.02 | Bal. |

Table 2. Probe dimension and welding conditions in friction stir welding for 5456-H116

| Probe Dia ; 5 Φ | | Probe Dia ; 6 Φ | |
|----------------------|--------------------------|----------------------|--------------------------|
| Rotation Speed (RPM) | Traveling speed (mm/min) | Rotation speed (RPM) | Traveling speed (mm/min) |
| 170 | - | 170 | 15 |
| 210 | - | 210 | 15 |
| 500 | 61, 124, 267, 342 | 500 | 15 |
| 800 | 61, 124, 267, 342 | 800 | 15 |
| 1100 | - | 1100 | 15 |
| 1800 | 61, 124, 267, 342 | 1800 | 15 |
| 2500 | - | 2500 | 15 |

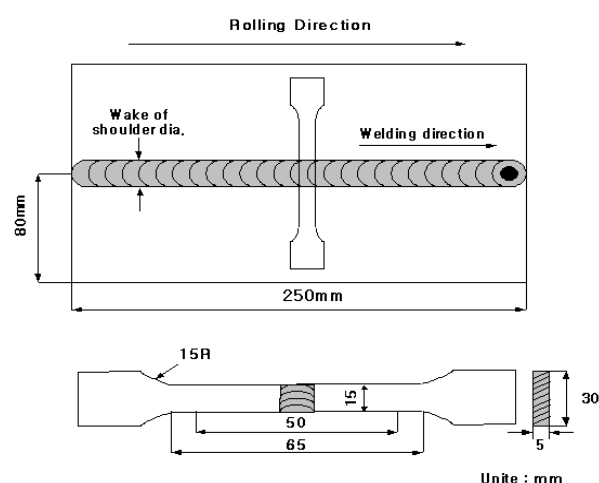

Fig. 1. Schematic diagram of tensile test specimen.

3. Results and Discussion

Welding was first conducted under various conditions using a 5-mm-diameter probe. Figure 2 shows the welds made with travel speeds of 500, 800, and 1800 rpm. The welds in 500 RPM made at 61 and 124 mm/min appeared generally smooth, whereas the 267 mm/min weld had a rough surface due to lack of heat input by the high travel speed (Kumar et al., 2012; Lawrjaniec et al., 2003). A tunnel-type void was formed from the start to the end point under all conditions. The size of the void increased with the travel speed due to incomplete penetration, and the shape of the button at the end point was more deformed at high travel speeds (Lee et al., 2003). This incomplete penetration was due to lack of sufficient friction heat (heat input) to generate plastic flow. At 800 rpm, the stir condition of 61 mm/min was good, with a void observed at the start and end points. The bead and stir conditions at

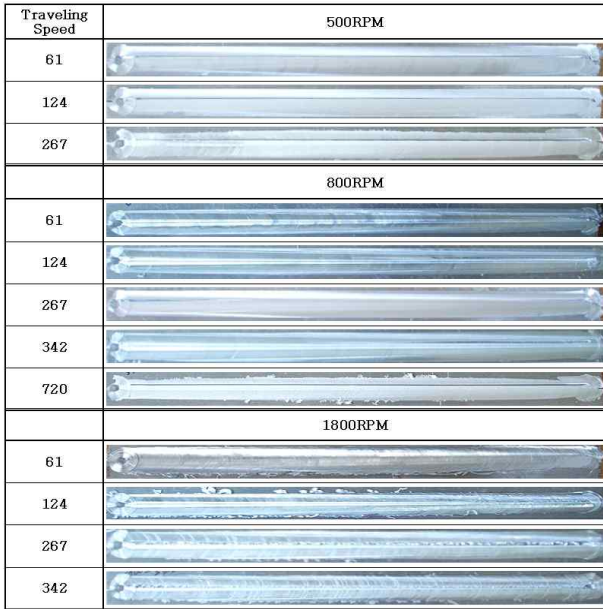

Fig. 2. Appearance in welded with probe dia 5 mm at various friction stir welding conditions.

124 mm/min were also good, but a void was generally formed. The weld appeared smooth at 267 mm/min, although there was a tunnel-type void present at the start and end points. At 342 mm/min, the void tendency was similar to that at 267 mm/min, but the bead was rougher. Welding at 720 mm/min produced a bad weld that was very rough, and a wide void was formed due to the lack of heat input. Therefore, as the travel speed increased, the weld surface became rougher, the void size increased, and the deformation of the button at the end point increased. These results suggest that the good weld surface achieved at low travel speeds was due to the increased heat input produced by sufficient friction. For a rotation speed of 1800 rpm and a travel speed of 61 mm/min, roughness and chip production were reduced by the high level of heat input produced by the high rotation speed. Some voids were observed at the start and end points of the button, and there was an increased tendency for rough beads and voids to form as the travel speed increased. At travel speeds greater than 124 mm/min, voids and a rough surface were readily apparent from the start to end points. With a slow travel speed, the bottom of the weld appeared white due to heat effects. The optimum parameters under the same conditions have been determined for 5083-O, but this proved impossible for 5456-H116 (Kim, 2007). Even at the same weld speed, the additional strength of 5456-H116 leads to weld defects that result from incomplete penetration and voids that occur because insufficient heat

flow is generated. The results at 500, 800, and 1800 rpm were also generally poor; the best characteristics were achieved at the slowest travel speed of 61 mm/min. Tensile tests were not possible for all specimens as in some cases complete penetration did not occur. Since the best welds were achieved at low travel speeds, an even lower speed of 15 mm/min was used to generate greater plastic flow by heat input, using a probe diameter of 6 mm.

Figure 3 shows a weld produced at a travel speed of 15 mm/min with probe diameter 6 mm. The bead at 170 rpm was rough, and a void was observed at the end point. The welded part appeared rough because the low rotation speed produced insufficient heat, and a void was probably formed inside. Similarly, at 210 rpm, the surface was somewhat rough due to the lack of heat input, and a void was observed at the start and end points. It is highly probable that a tunnel-shaped void formed from the start to the end points. On the other hand, at 500 rpm large chips were produced due to excessive physical force, but the sample shape was generally good. The mechanical characteristics were probably excellent because the button shape and the surface appearance were better at 500 rpm than at the other two rotational speeds. A travel speed of 15 mm/min produced good results, and the heat input increased with increasing rotation speed. However, the mechanical characteristics must be evaluated by a tensile test because a favorable surface appearance is not sufficient to decide whether a weld is good. At 800 rpm, probe stagnation was observed on the back due to excessive load. Chips were formed, but no void was observed, and the weld surface appeared smooth. A speed of 1100 rpm produced a generally good weld surface, plenty of chips, and a void at the end. In addition, part of the bottom surface had a zone that was affected by heat from the high heat input. A speed of 1800 rpm produced many chips and a rough weld surface, but no observable voids. At 2500 rpm, a very rough surface with chips was created; there were no voids, but there were considerable heat effects on the bottom, as at 1100 rpm. At 170 and 210 rpm and a travel speed of 15 mm/min, the weld surface was rough and voids were produced due to insufficient heat input at these low rotation speeds. Chips were observed at 500 and 800 rpm, but these were accompanied by a good weld surface without voids. However, many chips were produced at 1100, 1800, and 2500 rpm due to excessive heat input, and the heat effect on the bottom was quite noticeable. The surface appeared rougher for increased rotational speeds.

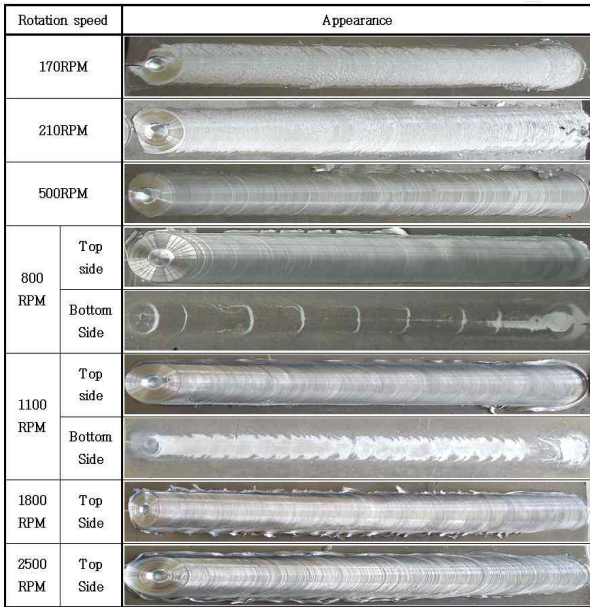

Fig. 3. Appearance in welded with probe dia 6 mm at various rotation speed in 15 mm/min.

Figure 4 shows the stress -elongation curves in FSW with probe diameter 6mm for a rotation speed of 15 mm/min. No results are shown for 170 rpm because the

experiment could not be completed due to the formation of voids at all travel speeds. The results at 500 rpm were similar, and the condition of the weld was good since the elongation was high, greater than 22%. At 800 rpm, the stresses to the point of 9% elongation were similar, and the appearance of the welded parts was good. However, the elongation at the fracture point showed a big difference due to incomplete penetration. In addition, at 1100 rpm, a void was observed at the button of the end point, but the stress-elongation curve was similar and the elongation was 20%. Reproducibility was guaranteed at 1800 rpm, and while this condition was generally good due to an elongation of 18%, it was not as good as at 1100 rpm. The weld surface at 2500 rpm was very rough, and no voids were observed, although a void was likely formed since the elongation determined from the results of the tensile tests showed several different values.

Figure 5 compares the average maximum tensile strength and the yield strength after the tensile test for the different friction-stir-welded specimens. The maximum tensile strengths in the rolling and vertical directions of the base material were similar. The tensile test for 210 rpm and 15

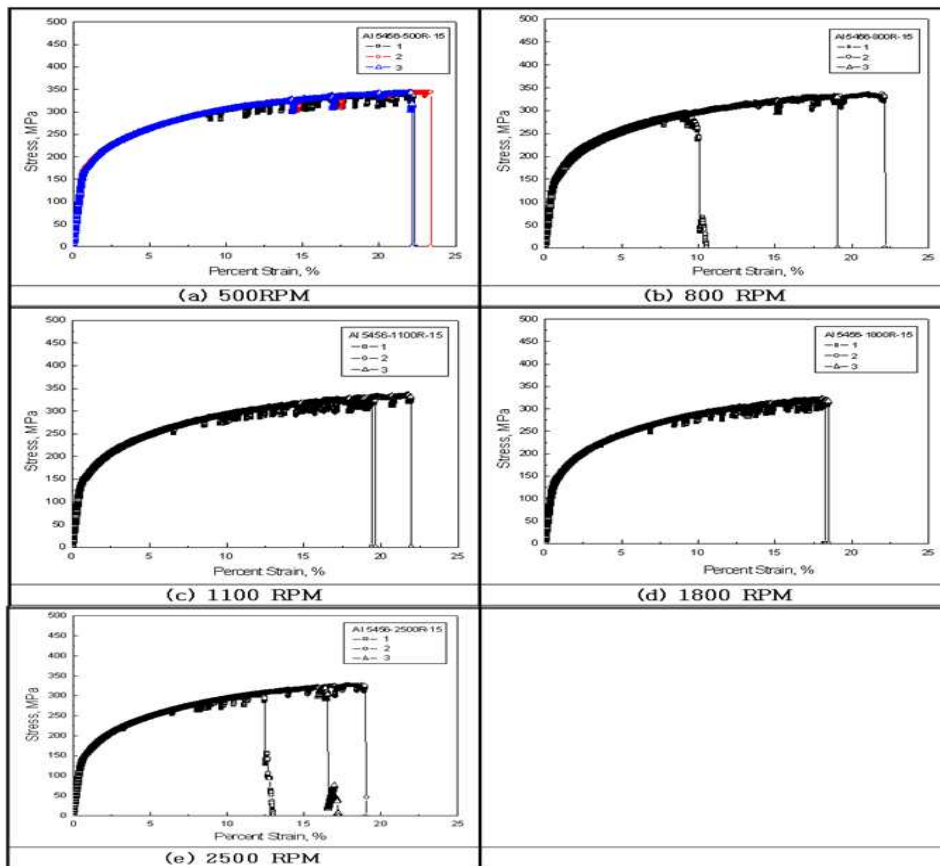

Fig. 4. Stress-elongation curves in FSW with probe dia 6 mm at various rotation speed and 15 mm/min.

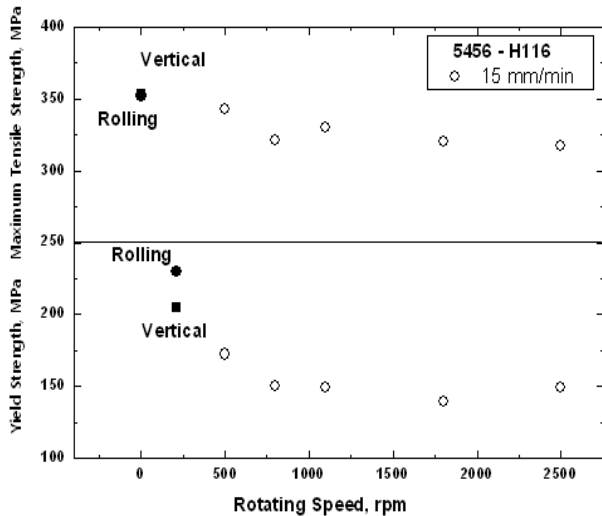

Fig. 5. Maximum tensile strength and yield strength after tensile test.

mm/min could not be determined due to weld defects. The tendency for defects at the same travel speed decreased with increasing rpm values, except at 800 rpm. The highest yield strength value appeared in the rolling direction of the base material, and it was 25 MPa higher than that in the vertical direction. For a travel speed of 15 mm/min, the maximum tensile strength decreased with increasing rpm values due to the heat input. However, the plastic flow characteristics improved, as the heat input increased with increasing rpm values. However, it appears that the strength was too low because of softening due to excessive heat input.

Figure 6 shows elongation and time-to-fracture after tensile test. The highest elongation value was in the vertical direction tensile specimen for rolling of base metal.

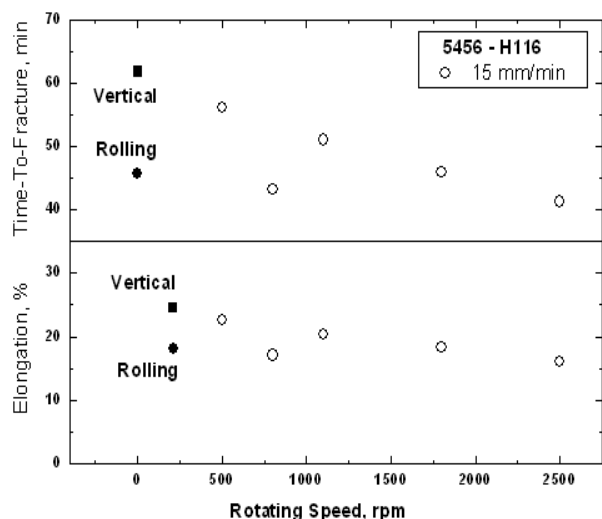

Fig. 6. Elongation and time-to-fracture after tensile test.

The highest elongation among all the conditions tested was at 500 rpm and 15 mm/min. At 15 mm/min, the elongation decreased with increasing rpm values, except at 800 rpm. The time-to-fracture was related to the elongation in the tensile test. The Al material was very ductile, and stretched before fracturing. The highest time-to-fracture was at 500 rpm and 15 mm/min. In addition, for a travel speed of 15 mm/min, the time-to-fracture decreased as rpm values increased, except at 800 rpm.

Figure 7 presents toughness after tensile test for various friction-stir-welded specimens. Toughness, which depends on the energy necessary to result in fracture, was related to elongation and affected the maximum tensile strength. The maximum toughness in the vertical direction for rolling of base metal was about 7796 kgf-mm, for 500 rpm and 15 mm/min. The toughness at 15 mm/min decreased as the rpm value increased. At 15 mm/min, the mechanical characteristics were degraded by the increased softness of the base material due to the increased heat input for higher rpm values.

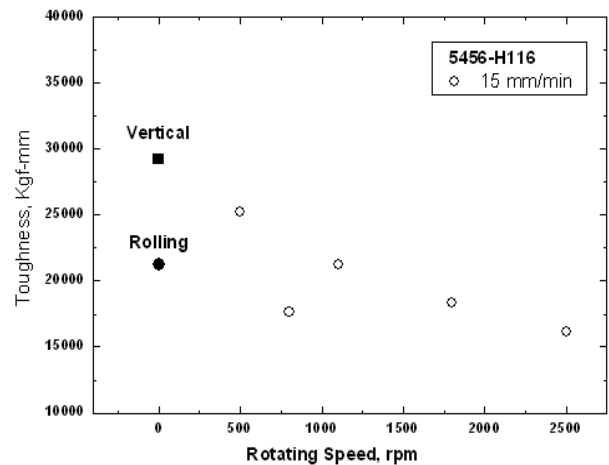

Fig. 7. Toughness after tensile test.

Examination of the fractured specimens after the tensile test revealed that chip production differed on the advancing and retreating sides; the retreating side generally produced more chips than the advancing side. In observations of the upper side, the fracture generally appeared on the retreating side at the center of the parallel part. In addition, the fracture appeared at the retreating side with the shifting to lower direction. The fracture on the lower side did not occur at the weld. For 500 rpm and 15 mm/min, chip formation was observed on the retreating side, and fractures appeared at the parallel part of the retreating side of fractured tensile specimen. Also, the fracture angle was observed at the retreating side with shifting to the lower side direction of cross-section for FSWed specimen.

4. Conclusions

Friction stir welding with a probe diameter of 5 mm and rotation speeds of 500, 800, and 1800 rpm was generally not very successful, but the best characteristics occurred for a travel speed of 61 mm/min. A travel speed of 15 mm/min with a 6-mm probe resulted in a rough surface with voids that were the result of insufficient heat input at the low rotation speeds of 170 and 210 rpm. At 500 and 800 rpm, chips were observed but no voids were apparent, and the weld surface was excellent. However, due to excessive heat input, many chips were observed at 1100 - 2500 rpm. In addition, heat effects were clearly visible on the bottom. At 15 mm/min, the mechanical characteristics were degraded by the increased softness of the base material due to the increased heat input for higher rpm values. The upper surface fractured on the retreating side at the center of the parallel part of tensile specimen. The fracture angle of tensile specimen was observed at the retreating side with the shifting to lower direction.

References

- [1] HUANG, GUI QIAO(2002), Corrosion Behavior of Aluminum Alloys in Seawater, *Corrosion science and technology*, 31(3), pp. 215-218.
- [2] KANG, B. Y. and J. H. CHO(2004), Consideration for structure and fabrication procedure of aluminum boat, *The Korean journal of welding society*, 22(3), pp. 39-44.
- [3] KIM, H. T., S. C. KIL, W. S. HWANG and W. S. CHO(2007), Investigation on the Corrosion Behaviour of Weld Structure, *Corrosion science and technology*, 6(1), pp. 33-35.
- [4] KIM. S. J(2006)., Evaluating the electrochemical properties in the protection potential of material for use in Al vessels in seawater, *Journal of Materials Science Forum*, 510-511, pp. 558-561.
- [5] KIM, S. J.(2007), Investigation of the optimum selection and protection characteristics for ship's shaft materials using impressed current cathodic protection, *The sixth pacific rim international conference on advanced materials and processing (PRICM 6) Korea*, p. 156.
- [6] KIM, S. J. and J. L. KIM(2007), Investigation on optimum corrosion protection for SCC and HE of Al-Mg alloy(5083-H) in sea water, *The sixth pacific rim international conference on advanced materials and processing (PRICM 6) Korea*, p. 136.
- [7] KIM, S. J., J. Y. KO, and M. S. HAN(2006), Evaluation of the characteristics using slow strain rate tests of 5456 Al-Mg alloy for ship construction, *The Korean journal of chemical engineering*, 23(6), pp. 1028-1033.
- [8] KIM, S. J., S. K. JANG and M. S. HAN(2007), Evaluation of mechanical characteristic of Al alloy for ship's welded with various welding techniques, *The Korea society of marine environment & safety*, 13(3), pp. 223-228.
- [9] KUMAR, Rajneesh, Kanwer SINGH and Sunil PANDEY (2012), Process forces and heat input as function of process parameters in AA5083 friction stir welds, *Trans, Nonferrous Met. Soc. China*, 22(2), pp. 288-298.
- [10] LAWRJANIEC, D., A. ABISROR, C. DECKER, M. KOCAK and J. DOS SANTOS(2003), Numerical simulation of friction stir welding, *Materials Science Forum*, 426(432), pp. 2993-2998.
- [11] LEE, W. B., Y. M. YEON and S. B. JUNG(2003), The joint properties of dissimilar formed Al alloys by friction stir welding according to the fixed location of materials, *Scripta materialia*, 49, pp. 423-428.
- [12] SAKAIRI, M., Y. SHIMOYAMA and D. NAGASAWA (2008), Electrochemical Random Signal Analysis during Localized Corrosion of Anodized 1100 Aluminum Alloy in Chloride Environments, *Corrosion science and technology*, 7(3), pp. 168-172.
- [13] SKY Al Products Corporation(2003), Foundation of Al alloy ship projects, *Journal of Japan Light Metal Welding*, 41(11), pp. 544-545.
- [14] SON, IN JOON, HIROAKI NAKANO, SATOSHI OUE, SHIGEO KOBAYASHI, HISAAKI FUKUSHIMA and ZENJI HORITA(2007), Effect of Annealing on the Pitting Corrosion Resistance of Anodized Aluminum - Magnesium Alloy Processed by Equal Channel Angular Pressing, *Corrosion science and technology*, 6(6), pp. 275-281.
- [15] TANABE, ZEN-ICHI(2011), FUMIO MATSUMOTO. Actualities and problems of Al alloy for the environmental resistance, *Journal of Japan Light Metal Welding*, 39(3), pp. 125-132.
- [16] YOON, B. H., H. J. KIM, W. S. CHANG and Y. G. KWEONG(2006), Corrosion Behavior of Arc Weld and Friction Stir Weld in Al 6061-T6 Alloys, *Corrosion science and technology*, 5(6), pp. 196-200.

Received : 2012. 05. 08.

Revised : 2012. 06. 15.

Accepted : 2012. 06. 25.