

# Algorithm for Measurement of the Dairy Cow's Body Parameters by Using Image Processing

Kwang W. Seo<sup>1</sup>, Dae W. Lee<sup>2</sup>, Eun G. Choi<sup>3</sup>, Chi H. Kim<sup>3</sup>, Hyeon T. Kim<sup>3\*</sup>

<sup>1</sup>The Korean Intellectual Property Office, Daejeon, Korea, <sup>2</sup>Department of Bio-mechatronics, Sunkyunkwon Univ., Suwon, Korea, <sup>3</sup>Department of Bioindustrial Machinery Engineering (Insti. of Agric. & Life Sci.), Gyeongsang National University, Jinju, Korea

Received: April 27<sup>th</sup>, 2012; Revised: April 28<sup>th</sup>, 2012; Accepted: April 29<sup>th</sup>, 2012

## Abstract

**Purpose:** Recent mechatronics technology is the most appropriate high technology in agricultural applications to save repetitious labor. **Method:** Cow's body parameters were measured by several traditional measurers. Image processing technology was used to measure automatically their parameters to reduce labor and time. The parameters were measured from a small model cow which is easily measured, instead to a real cow. The image processing system designed and built for this project was composed of a PC, grabber card, and two cameras, which are located on the side and the top of the model cow. Tests of verification had measured 10 dairy cows. **Result:** Nine parameters of the model cow's body were measured, and the difference between the real data and the data by image processing was less than 16.7%. Based on the results of the research, the parameters of a real cow had measured of chest depth, withers height, Pelvic arch height, body length, slope body length, chest width, hip width, thurl width, and pin bone width were compared with image processing data. **Conclusions:** In the Demonstration test, Result had obtained similar data of cow model experiments, and the most of errors were shown less than 5% relatively good result.

**Keywords:** Image processing, Dairy cow, Body parameters, Individual management

## Introduction

Recently, the livestock in Korea decreased the number of farmhouses and animals. We have to maintain the minimum agriculture in a difficult agricultural situation. The agriculture situation of Japan and Korea has faced on several problems, such as an advanced age, environmental preservation, food safety and the counter plan of WTO (World Trade Organization).

The cow's parameter is in general used for breeding and improvement of cows in animal science fields. But the cow's body parameter is manually measured. Specifically, the cow's body parameter measurement is studied for weight prediction. Several researchers have developed

methods of weight prediction of cows by the body parameters (Heinrich et al., 1987; McDaniel et al., 1965; Swanson, 1966; Anderson, 1976; Batra et al., 1974).

Image processing technology for measuring the cow's body parameters would be much more attractive if there was a way to assure that each cow's parameters were measured without a mistake. If they were measured by using image processing, they would help to improve the cow's quality by determining early in its infancy whether it will grow into a good or bad cow. Currently, the parameters were not measured automatically by the advanced technology but they are still being measured manually with the traditional measurer and pelvis measurer, which required time-consuming and repetitious difficult labor.

Recently, the production of the livestock must consider the animal welfare and precise environment control. Research on dairy cattle was conducted by using image

\*Corresponding author: Hyeon T. Kim

Tel: +82-55-772-1896; Fax: +82-55-772-1899

E-mail: bioani@gnu.ac.kr

processing (Morio and Ikeda, 2000; Morio et al., 2003). But, those studies are focused on the identification for the precision livestock farming. Therefore, the research result regarding the measurement of cow's body parameters is used for the precision livestock farming.

In addition, Yan et al., 2004, developed and evaluated a model for estimating pig's weight using computer vision for improving the management in Korean swine farms in Korea. And, Lee, 2003, was conducted to develop the stereo vision system for non-invasive analysis of cow body features. In that study, the camera calibration and inverse perspective transformation technique was established for the stereo vision system. However, that research measured cow's body parameters using feature points that determined manually.

The body parameters based on auto detection will play an important improvement role for physical bio signal measurement of animals. Ultimately it will be possible to analyze bio physical signs from animals.

Therefore, this study proposed algorithm for detecting cow's feature points automatically, and designed and developed the image processing system and image processing algorithms for measuring body parameters of cows by using CCD-camera.

## Materials and Methods

### Image Processing System

This study was conducted to automatically measure the cow's body parameters, which are used for improvement of the cow in livestock production facilities. Measurement of her body parameters, which was executed by hand with the traditional measurer for her body parameters, used to take so much time and labor that a

computer image processing technique came into use for easy and automatic measurement of the parameters. Figure 1 shows an image processing system which can measure the parameters of the model cow in our laboratory.

The parameters were measured from a small model cow instead of a real cow. A real cow could not be easily measured because she does not stand still but moves around constantly while her parameters are being measured. The image processing system designed and constructed for this project was composed of a Pentium PC, a TV frame grabber card, and two digital-matrix cameras as shown in Table 1. Cameras were set up on the side and the top of the model cow as shown in Figure 2. The top camera views an area cm by cm at a distance of 30 cm from the bottom of system. And also the side camera

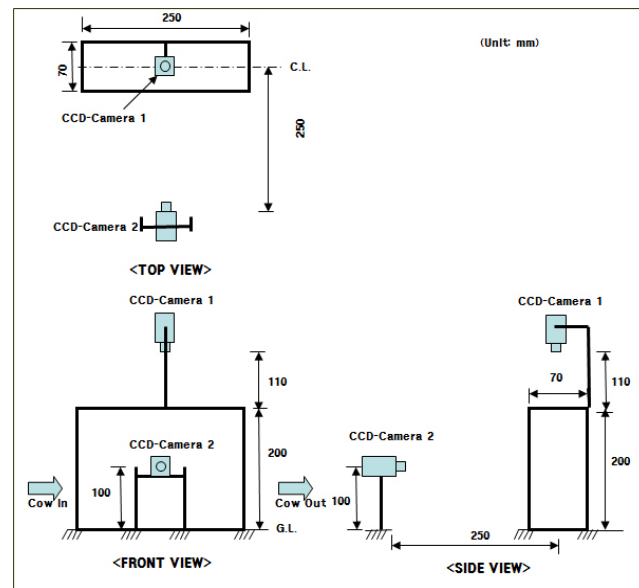

Figure 1. Dimensional sketch of the vision system for measuring body parameters.

Table 1. Specification of CCD camera

| Model             | Specification         |                                    |
|-------------------|-----------------------|------------------------------------|
| ICD-703<br>(NTSC) | Pickup Device         | 1/3" Interline Transfer CCD        |
|                   | Picture elements      | 771×492, 380,000 pixels            |
|                   | Scanning system       | 525 lines/59.94 Hz, 2:1 interfaced |
|                   | Frequency             | H:15.734 kHz, V:59.94 Hz           |
|                   | Horizontal Resolution | 480 TV Lines                       |
|                   | S/N Ratio             | 50 dB (p-p/rms)                    |
|                   | Shutter               | 1/60-1/80,000 sec.                 |
|                   | Dimensions (WHD)      | W70×H60×D140 mm                    |

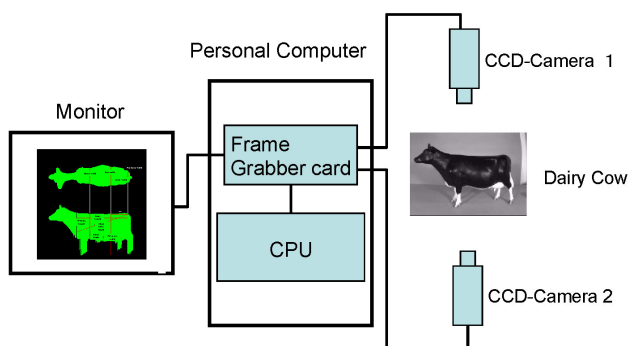

Figure 2. Block diagram of the image processing system.

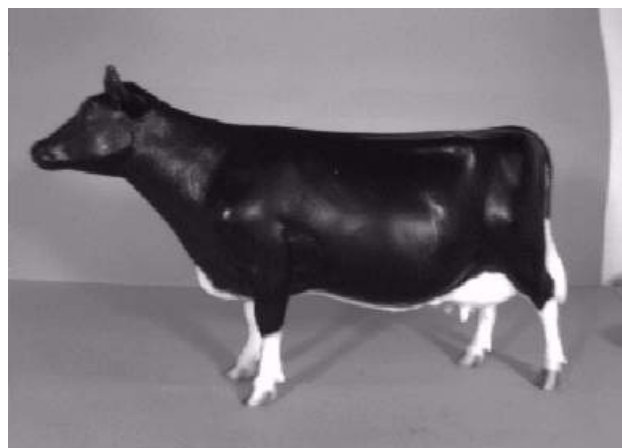

Figure 3. The model cow for the algorithm development.

Table 2. Body parameters of the model cow

| Body parameters | Withers height | Hip width | Chest depth | Slope body length | Thurl width | Chest width | Pelvic arch height | Pin bone width | Body length |
|-----------------|----------------|-----------|-------------|-------------------|-------------|-------------|--------------------|----------------|-------------|
| Size (cm)       | 15.1           | 6.2       | 9.0         | 18.0              | 5.8         | 6.0         | 14.2               | 3.0            | 16.5        |

views an area cm by cm at a distance of 25 cm from the center line of system. The light source for image detection was the overhead fluorescent lamps with 200V and 60W mounted on the side and the top side of the cow.

## Materials

The size of the model cow (see Figure 3) in the laboratory is about one tenths of a real cow. The values of her body parameters were measured from the model cow by using the venire calipers and tapeline. The results are shown in Table 2.

## Algorithm of the measurement

### Subtractive calculation for the cow's image detection

The frame grabber board can digitize, display and process multiple images with spatial resolution of 640 x 480 pixels with 0 (black) to 255 (white) intensity levels. However, the computer monitor screen had a spatial resolution of 320 x 240 pixels. All the image processing functions were performed on the whole image, even though the monitor could not display all of the resulting information.

Since the illumination was not evenly distributed across the image, it was necessary to compensate the intensity values of an image for the anomaly. In order to compensate an image with noises, two cameras captured

the first image from background, and then captured at once the second image of both the cow and the background. If the second image (which has both the object and the background image) were subtracted the first image (which has only the background image), then, the result of subtraction will have only the object. However, the subtracted image had not only the object image, but also the noise image.

The intensity value of a pixel, which was obtained from a subtracted image, was less than that of the second original image, or less than the intensity value zero. In the case of less than intensity value zero, it cannot see the image on the computer monitor.

Subtractive calculation plays the role of diminishing brightness, since the intensity value of a resulted image is less than that of an original image. The image brightness could be represented on the monitor if the reduced value reached to minus. The Subtractive calculation function is represented as equation (1).

$$\text{Output } (x, y) = \text{Image I } (x, y) - \text{Image II } (x, y) \quad (1)$$

Where image I is the image with both the object and the background images, image II is the image with only the background image, and x, y are the pixel position of the image.

Subtractive calculation between the intensity values of

two images is divided by two methods. One is an absolute value which subtracts the value of one image from another image. The other removes unwanted values, which are more than 256, or less than 0 values. These two methods of subtractive calculation can be obtained from equations (2) and (3).

$$\text{Output } (x, y) = | \text{Image}_1 (x, y) - \text{Image}_2 (x, y) | \quad (2)$$

$$\text{Output } (x, y) = \text{Image}_1 (x, y) - \text{Image}_2 (x, y) \quad (3)$$

When processing the calculation with pixels in the computer image processing, the output value is made by using Saturation and Wrap shown in Figure 4.

The saturation method is a way of describing the value 255 for the value over 255, The Wrap method is a way of repeating from 0 to 255 value in the cycle of 0~255.

In this study, the cow's body parameters were measured by using subtractive calculation in the use of each pixel's intensity value information. It not only decreased unwanted images but also decreased the noises made for processing the cow image.

*The algorithm for removing noises.*

In the process of removing the unwanted components of images, the image techniques made the noises and blurred edges and other sharp detail. Development of this algorithm grew out of the need to study ways to bur them and remove noises generated by small noise particles in

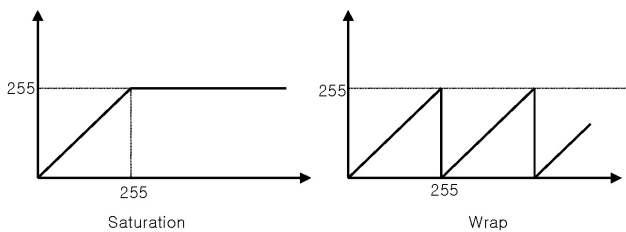

Figure 4. The methods of saturation and wrap.

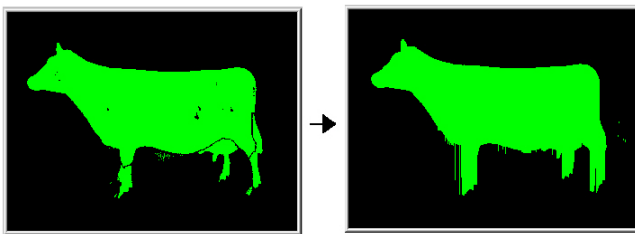

Figure 5. Comparison of the effect of the image and the processed image.

this study.

While processing an image with subtractive calculation, the image is divided into two part images, the object part and the background part. In one vertical line, we will search the non-zero value pixel that is object part. Then, we will connect every pixel between the first to last object pixel. The all the vertical lines are processed by using the same method as that shown in Figure 5. This method helped to quantify the cow's body parameters, and it reduced noise and other spurious effects, which occurred in images as a result of quantifying, transmitting or disturbances in the environment during acquisition. However, the use of this method results in the loss of background image data.

*Calculation of the size of the image pixel*

In the image processing system, a CCD camera used a lens of 4.8 mm 1:1.8. Figure 6 shows the relationship between the pixels of whole image and the actual size of a cow's body parameters to compare the distance between the camera and the cow.

The correlation between the pixel number and the actual distance from the camera to the cow can be obtained from equation (4).

$$Y = e (0.0693x - 3.8712) \quad (4)$$

where,

Y = actual size per one pixel (cm/pixel)

X = distance between camera lens and center of cow's body (cm)

Using equation (4), we measured the model cow's body parameters using of the distance between the camera and cow.

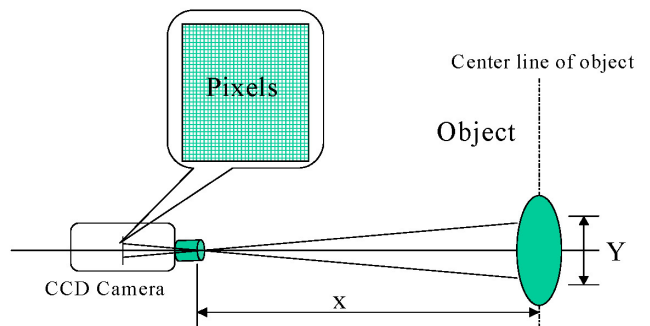

Figure 6. The method of camera lens calibration.

### Detection of a Cow's Body Parameters

Software, written in visual C++ of Microsoft, combines the functions of image capture, image processing, and measurement of the cow's body parameters. The program is a menu driven program to measure the body parameters of the model cow's body.

To detect her parameters, the Figure 7 is shown the searching area for measuring four parameters from the top view image. The four parameters are chest width, hip width, thurl width, and pin bone width.

The Figure 8 is shown the four critical points for four parameters measurement from the upper surface image. Four critical points were obtained by using the first order differential (inclination) of the line.

A Figure 9 is shown a picture for measuring five para-

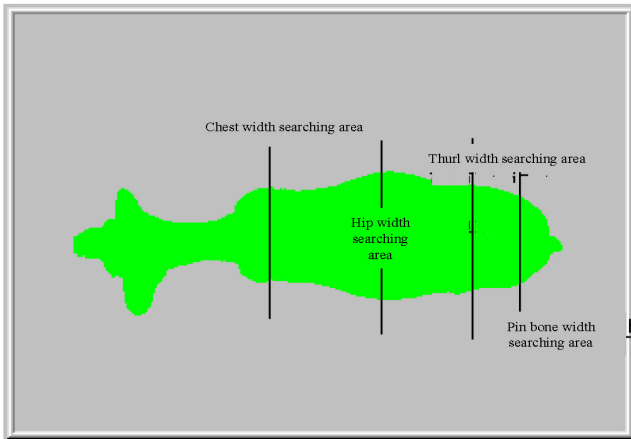

Figure 7. The projective object image form top-view camera with four characteristic lines.

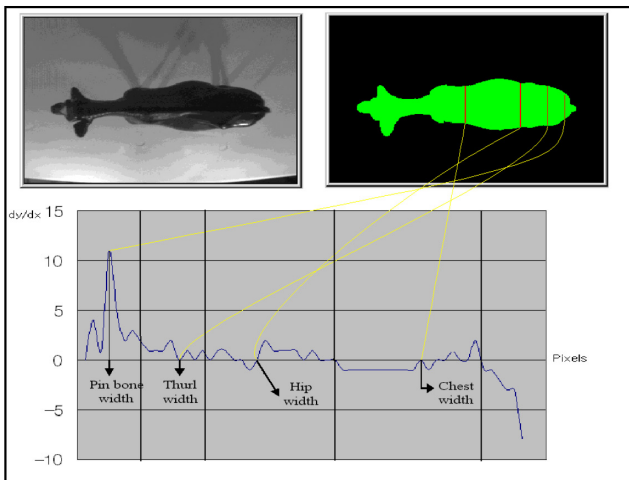

Figure 8. Intensity profiles taken from the prospective line in the top-view image.

eters which can measure on the side view image. The measuring of the five parameters is based to the four parameters which were measured with the top view image.

The chest depth is based the chest width, the pelvic arc height is based the hip width. The withers height measured from lowest point of lag to top pixel in vertical direction. And, body length and slope body length is based pin bone width in the top view image.

Figure 10 was shown the flow chart the sequence of operations followed in calculating the model cow's body parameters.

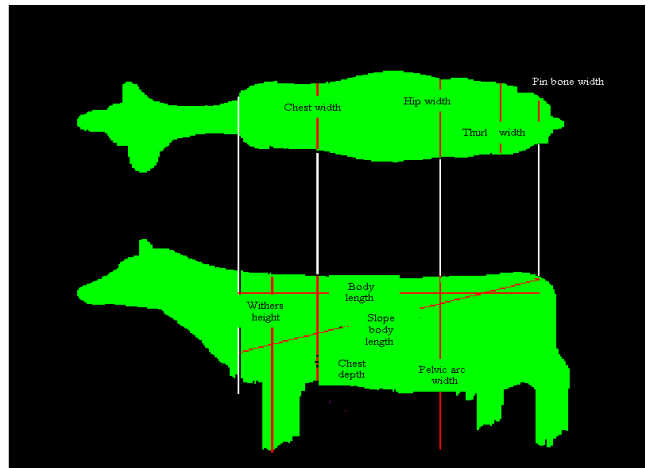

Figure 9. Detection of characteristic cow's parameters of the projective object image with four characteristic lines.

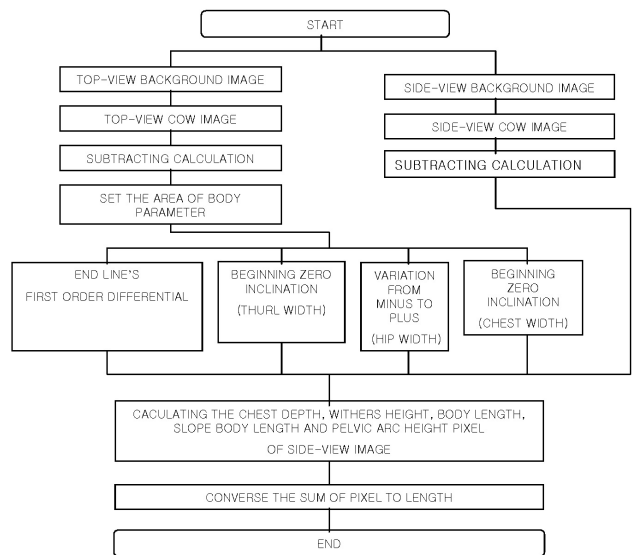

Figure 10. The algorithm of detecting for body parameters.

## Verification test of real dairy cow

For investigation of dairy cow body parameters, visited the barn near Suwon area. This verification test was measured 10 dairy cows.

## Results and Discussion

Three image processing techniques were used to enhance computer vision detection of the model cow's body parameters in the computer processing system in the image processing laboratory. Table 3 shows eleven body parameters of the model cow measured in the image processing system.

The result showed that the measurement errors of the body parameters ranged from 1.1% to 16.7%. The Pin bone width of 16.7% is the largest measurement error in the nine body parameters measured, and the measurement error of the hip width is 14.5%.

In addition, the measurement error of the withers height 2.0%, pelvic arch height 4.9%, chest depth 1.1%, slope body length 3.3%, body length 3.0%, chest width 6.7%, and thurl width 5.2%.

The measurement error of pin bone width and hip width was attributed to the starting point and the terminal point which were influenced by the light in the measuring process. Moreover, it appeared with the measurement error of the body parameters that used the top view image from Camera 1 larger than the measurement error of the body parameters using the side view image from camera 2. The reason of the difference is considered under the influence of the shadow which is made by light source in the side. That is contained in the top view image of the cow. Therefore, we need to complement the measurement algorithm to the light source to reduce measurement errors.

In the tests had measured 10 dairy cows, for verification of Algorithms. Field experiments without the influence of the solar light, dairy cows detected interior space under the fluorescent lamps in the process of passing, detected the top and side images of dairy cows. It has same color because of floor and sidewalls to make easier to identify the appearance of cows. Dairy cow's body measurements in the same way as the laboratory tests were performed. Fig. 11 is the top and side image of a dairy cow through the camera is the result of positional measurements.

Values of favorable twice or three time measuring 15 cow's body parameters was compared with actual measurements. It was measured by 10 cow's body parameters except of the impossible to experiment 5 wild cows. Table 4 showed the estimated value of image processing and the value of measured with a tape measure. The results compared to other errors are relatively large between measured values and image processing measurement values has occurred chest girth, pelvic arch height. Almost body parameters error was less than 5% and represents a relatively good result except for one or two unusual cows.

The result was examined each body parameters in detail, number 10 cow chest depth error occurred almost 15%, number 5 cow chest depth error occurred about 9%, but other cows chest depth relatively accurate to

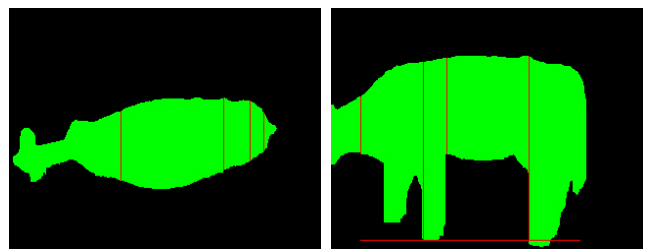

Figure 11. The top and side image of a dairy cow through the camera.

Table 3. Cow's body parameters measured with the model cow (units; cm)

| Type               | Measured from the side view image |                    |             |                   |             | Measured from the top view image |             |                |             |
|--------------------|-----------------------------------|--------------------|-------------|-------------------|-------------|----------------------------------|-------------|----------------|-------------|
|                    | Withers height                    | Pelvic arch height | Chest depth | Slope body length | Body length | Hip width                        | Chest width | Pin bone width | Thurl width |
| Measured value     | 15.1                              | 14.2               | 9.0         | 18.0              | 16.5        | 6.2                              | 6.0         | 3.0            | 5.8         |
| Calculated value   | 15.4                              | 14.9               | 8.9         | 18.6              | 17.0        | 7.1                              | 5.6         | 3.5            | 6.1         |
| Aberration (error) | -0.3 (2.0%)                       | -0.7 (4.9%)        | 0.1 (1.1%)  | -0.6 (3.3%)       | -0.5 (3.0%) | -0.9 (14.5%)                     | 0.4 (6.7%)  | -0.5 (16.7%)   | -0.3 (5.2%) |

**Table 4.** The results of body parameters in the field dairy cow

| Body parameters<br>No. of dairy | Chest depth |    |      | Withers height |     |      | Pelvic arch height |     |      | Body length |     |   | Slope body length |     |      |
|---------------------------------|-------------|----|------|----------------|-----|------|--------------------|-----|------|-------------|-----|---|-------------------|-----|------|
|                                 | A           | B  | C    | A              | B   | C    | A                  | B   | C    | A           | B   | C | A                 | B   | C    |
| 1                               | 82          | 79 | 3    | 141            | 132 | 9    | 147                | 136 | 11   | 168         | 168 | 0 | 175               | 170 | 5    |
| 2                               | 83          | 82 | 1    | 141            | 137 | 4    | 145                | 139 | 6    | 164         | 161 | 3 | 169               | 171 | 2    |
| 3                               | 81          | 77 | 4    | 134            | 128 | 6    | 138                | 139 | 1    | 164         | 161 | 3 | 166               | 165 | 1    |
| 4                               | 87          | 84 | 3    | 140            | 136 | 4    | 146                | 138 | 8    | 170         | 171 | 1 | 180               | 174 | 6    |
| 5                               | 84          | 77 | 7    | 142            | 136 | 6    | 144.5              | 140 | 4.5  | 168         | 164 | 4 | 167               | 169 | 2    |
| 6                               | 86          | 82 | 4    | 140            | 145 | 5    | 141                | 134 | 7    | 171         | 168 | 3 | 173               | 171 | 2    |
| 7                               | 79          | 71 | 8    | 135            | 130 | 5    | 139                | 134 | 5    | 159         | 152 | 7 | 162               | 165 | 3    |
| 8                               | 88          | 83 | 5    | 136            | 142 | 6    | 139                | 129 | 10   | 161         | 166 | 5 | 167               | 168 | 1    |
| 9                               | 78          | 72 | 6    | 132            | 131 | 1    | 146                | 135 | 11   | 158         | 156 | 2 | 179               | 167 | 12   |
| 10                              | 77          | 67 | 10   | 133            | 128 | 5    | 137.5              | 127 | 10.5 | 162         | 164 | 2 | 165               | 164 | 1    |
| Aver.                           |             |    | 5.1  |                |     | 5.1  |                    |     | 7.4  |             |     | 3 |                   |     | 3.5  |
| Std. Dev.                       |             |    | 2.68 |                |     | 2.02 |                    |     | 3.33 |             |     | 2 |                   |     | 3.44 |

| Body parameters<br>No. of dairy | Chest width |    |      | Hip width |    |      | Thurl width |    |      | Pin bone width |    |      | Chest girth |     |      |
|---------------------------------|-------------|----|------|-----------|----|------|-------------|----|------|----------------|----|------|-------------|-----|------|
|                                 | A           | B  | C    | A         | B  | C    | A           | B  | C    | A              | B  | C    | A           | B   | C    |
| 1                               | 55          | 49 | 6    | 61        | 58 | 3    | 56          | 49 | 7    | 45             | 35 | 10   | 206         | 201 | 5    |
| 2                               | 54          | 47 | 7    | 61        | 58 | 3    | 51          | 48 | 3    | 41             | 37 | 4    | 210         | 203 | 7    |
| 3                               | 60          | 57 | 3    | 64        | 58 | 6    | 58          | 57 | 1    | 46             | 43 | 3    | 200         | 210 | 10   |
| 4                               | 51          | 47 | 4    | 63        | 52 | 11   | 55          | 55 | 0    | 44             | 35 | 9    | 204         | 206 | 2    |
| 5                               | 54          | 57 | 3    | 60        | 55 | 5    | 55          | 47 | 8    | 45             | 43 | 2    | 211         | 210 | 1    |
| 6                               | 56          | 53 | 3    | 62        | 57 | 5    | 56          | 58 | 2    | 44             | 38 | 6    | 210         | 212 | 2    |
| 7                               | 45          | 46 | 1    | 58        | 66 | 8    | 55          | 49 | 6    | 43             | 49 | 6    | 190         | 184 | 6    |
| 8                               | 55          | 57 | 2    | 62        | 55 | 7    | 55          | 49 | 6    | 42             | 35 | 7    | 201         | 220 | 19   |
| 9                               | 51          | 54 | 3    | 58        | 55 | 3    | 56          | 47 | 9    | 41             | 35 | 6    | 195         | 198 | 3    |
| 10                              | 53          | 56 | 3    | 59        | 52 | 7    | 54          | 55 | 1    | 38             | 33 | 5    | 202         | 193 | 9    |
| Aver.                           |             |    | 3.5  |           |    | 5.8  |             |    | 4.3  |                |    | 5.8  |             |     | 6.40 |
| Std. Dev.                       |             |    | 1.78 |           |    | 2.57 |             |    | 3.26 |                |    | 2.48 |             |     | 5.46 |

A : Measured value  
 B : Calculated value  
 C : Error

within 5% was measured. In the case of withers height, number 1 cow had showed an error of 6.8%, but except it was almost exactly within 5%.

Numbers of 1, 8, 9 and 10 cow's pelvic arch height error has occurred about 8%. It is large error compared to other body parameters error. Such a result can be anticipated on cow's iliac area shape slope error. In the case of body length had measured less than 5% errors, because cow's body length can be formed measurements relatively accurate.

Slope body length of the number 9 cow has error of 7.2% and except of this error others has showed a similar level of cow's body length. Because slope body length and

body length used the same characteristics points, it should be noted the same error value, but the random errors were determined by experimenter. Chest width has a relatively accurate data except number 1, 2 cows.

Number 9 cow hip width was showed 20% error. Because chest width and pelvic arch height of the measuring points was same positions, that points were responsive most sensitive to the cow position. Thurl width was similar results in the hip width. Pin bone width was showed similar level of others error, except number 1 cows measurement value.

## Conclusions

The body parameters of cow are an important element in selecting and breeding cows. However, the measurement of parameters requires much labor and time. We measured the cow's body parameters by using digital image processing with an image processing algorithm. Based on the results of this research the following conclusions were reached:

The errors between the measured values of 9 parameters of the model cow and values calculated by the image processing algorithm were within 16.7%. They did not exceed the errors, which were generated by manual measurement.

In the verification, hip width and pelvic arch height has showed large errors compared to other body parameters. But body length was a good result within 10 cm error. This result had obtained similar data of cow model experiments, and the most of errors had less than 5% showed, relatively good result.

## Conflict of Interest

No potential conflict of interest relevant to this article was reported.

## References

- Heinrich, A. J. and G. L. Hargrove. 1987. Standard of weight and Height for Holsteinheifers. *J. Dairy Sci.* 70:653-660.
- McDaniel, B. T. and J. E. Legates. 1965. Association between body weight Predicted from hert girth and production. *J. Dairy Sci.* 49:947-956.
- Swanson, E. W. 1966. Optimum growth patterns of dairy cattle. *J. Dairy Sci.* 50:244-252.
- Ralph, R. A. 1976. Relation between mammary gland development and body weight. *J. Dairy Sci.* 59: 1518-1521.
- Batra, T. R. and R. W. Touchberry. 1974. Weights and body measurements of Purebred Holstein and Guerusey Females and Their Crossbreds. *J. Dairy Sci.* 57:842-848.
- Morio, Y. and Y. Ikeda. 2000. Development of Holstein Cow Identification System Using Black and White Patter, Proc. Of the XIV Congress CIGR P2204.
- Morio, Y., Y. Ikeda and K. Horibe. 2003. Holstein Identification with Robustness against Lighting Condition, *Journal of the Japanese Society of Agricultural Machinery*, vol. 65, no. 2, pp. 94-100.
- Lee, J. W. 2003. Information Processing and Interdisciplinary Technology : Development of Computer Vision System for Individual Recognition and Feature Information of Cow (2) - Analysis of body parameters using stereo image. *Journal of Biosystems Engineering* 28(1):65-76.
- Yan, T. Y. and J. H. Chung. 2004. Information Processing and Interdisciplinary Technology : Development of a Pig's Weight Estimating System Using Computer Vision. *Journal of Biosystems Engineering* 29(3):275-280.