

Automatic Tension Control of a Timber Carriage Used for Biomass Collection

Yun Sung Choi¹, Jae Huen Oh², Seung Hee Euh¹, Kwang Cheor Oh¹, Hee Jin Choi¹, Dae Hyun Kim^{1*}

¹Dept. of Bio-system Engineering, Kangwon National University, Chuncheon, Korea,

²Korea Forest Research Institute, Pocheon, Korea

Received: April 20th, 2012; Revised: April 25th, 2012; Accepted: April 27th, 2012

Abstract

Purpose: A lab-scale timber carriage using a servo motor system was built. When two motors move a carriage, wire tension is changed according to the different line speeds caused by a wire drum's changing diameter, leading to inappropriate traveling characteristics of the carriage. In order to overcome this problem, PID Control was used to control the motor speed. **Methods:** Ziegler-Nichols method was used to determine PID gains. **Results:** The initial PID gains were 1.8, 0.025, and 0.006, respectively, and optimal gains of 1.4 and 0.010 for P and I gain were obtained experimentally. **Conclusions:** The results showed that constant wire tension could be maintained by controlling the speed of the motor using PI control. Overshoot occurred at initial motor operation due to vibration and elasticity of the wire itself.

Keywords: Servo motor, PID control, Timber carriage, Ziegler-Nichols

Introduction

Due to the current rise in oil prices, fossil energy resources are becoming a center of international relations and economic problems, and as such, the need to develop a new alternative energy sources is increasing. Energy sources to replace fossil fuels including discarded waste timber can be used as raw materials for bioenergy, and are available for continued use, with added benefits of being carbon-neutral and environmentally friendly. However, due to economic problems and difficulties in collection, these wood-based resources are being left as waste, and they are both a forest fire hazard and can potentially cause damage to areas downstream of processing facilities during intensive rainfalls. As such, there is a need for the development of a timber carriage that can transport scattered timber after felling, processing and skidding. In Korea, most timber carriages that are used in skidding are imported, and consumers of this equipment are calling for improvement in many areas as well.

The winches used in most timber carriages are hydraulic systems that have an interlock system. When a drum cable on the winch is wound, a change in the drum diameter occurs which causes variation in the cable speed, causing inconstant tensions in the cables, thereby preventing smooth transportation of the timber. To solve this problem, micro-controllers and hydraulic systems are generally utilized in the design of timber carriages to control the tension in cables, but the control of this system can become complex due to excessive nonlinearity in the electric hydraulic valve cylinder. In particular, electric hydraulic equipment can experience limitations in control performance, which is expressed in terms of response time, accuracy and safety when a dynamic input or nonlinear element is applied (Anderson, 1988).

Accordingly, research on control for small-size timber carriages that use servomotors instead of hydraulic systems is in progress. Although hydraulic systems produce large torques with low noise, they are prone to positional deviations caused by temperature variations. However, servomotor systems are capable of precise control and have high maximum torque despite small size.

*Corresponding author: Dae Hyun Kim

Tel: +82-33-250-6496; Fax: +82-33-255-6406

E-mail: daekim@kangwon.ac.kr

Before developing a farm-scale timber carriage with a servomotor that can be used on site, a lab-scale timber carriage was developed.

PID Proportional, integral and derivative controllers (PID) are used widely in industry because they are simple in design and have fewer parameters, but show satisfactory control performance characteristics (Astrom and Hangglund, 1984; Kim et al., 1999).

PID control is applied in various fields including in the development of temperature control for pretreatment of agricultural products and samples (Kim et al., 2009), positional control of agricultural tractors (Kim et al., 2009), and positional control system for hydraulic cylinders (Kim et al., 2009).

In PID control, a tuning method for setting optimum parameters in accordance with the system's changes in characteristics. One popular method was developed by Ziegler and Nichols developed in 1942, considers the effects of sensitivity for optimum settings (Astrom et al., 1995).

In this study, a servomotor system for the operation of timber carriages was designed and built using this method. The purpose of this study was to design an accurate and optimized system by comparatively analyzing the results from experiments and simulation.

Materials and Methods

Design of servomotor system for timber carriage

Winches used in timber carriages are mostly driven by hydraulic motors, and since precise control is required in this study, electric servomotors with superior electric power transmission and precise control were used.

Principle of timber carriage was shown in Fig. 1. When the carriage travels by the two motors, wire tension (T_1

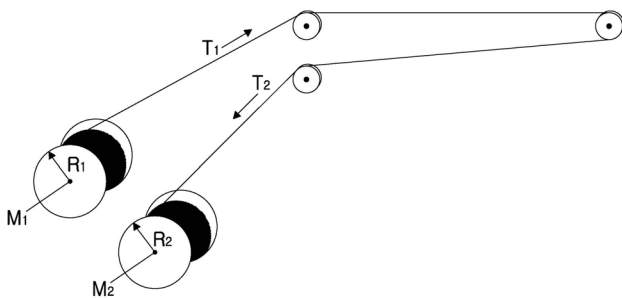

Figure 1. Principle of timber carriage.

and T_2) is changed according to different line speeds caused by changing drum diameters (R_1 and R_2), leading to inappropriate travel of the carriage. In order to overcome this problem, tension output measured by a loadcell was compared with a preset tension value, and the deviation between the measured data and target value was controlled by PID Control in order to maintain constant tension ($T_1 = T_2$).

The system configuration and components operating specifications

The system's frame was constructed with aluminum profile ($0.4 \times 0.8 \times 9$ m, MP4080S, Gumi, Korea) and was configured with a timber carriage and wire (2 mm diameter), an electric panel, and a control box that can control the servomotors (Fig. 2).

Servo motor and drive

Servomotor was configured with haul (LF09, HIGEN, Seoul, Korea) and haul-Back (LF06, HIGEN, Seoul, Korea)

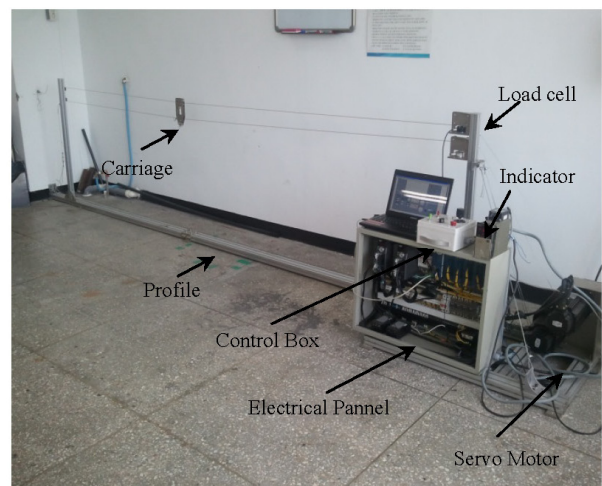
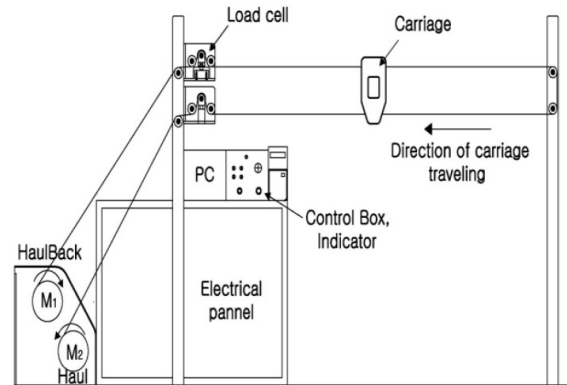

Figure 2. System Configuration.

motors. The haul motor's rated output is 900 W, and the rated torque is 8.62 N·m. The nominal rotational speed is 1000 rpm. The haul-Back motor's rated output is 600 W, its rated torque 5.68 N·m, and the rated rotational speed is the same as that of the haul motor. The servomotors are operated by the control box and servo drive signals. The Servo drives used in haul motor and haul-back motor are the FDA7005 and FDA7010 systems (HIGEN, Seoul, Korea), respectively, and they are operated with signals coming through the control box that are received by the servo drives, and an output signal is sent to servomotors.

Loadcell and indicator

The loadcell (BONGSIN, CDES-100, Seongnam, Korea) can measure compression and tension loads, and the rated capacity and energy output are 980 N and 2 mV±0.25%, respectively. The indicator (KYOWA, WGA-710A, Kyowa, Japan) receives output signal from the load cells and amplify, convert and sends output signals, and it enables the verification of loads being applied to load cells and through a display.

Control box

The control box consists of a joystick (WJ-200, Devicemart, Seoul, Korea) that controls the servomotors, a power switch, interlocked and individual operation switches, a variable resistor for tension adjustment, an emergency stop switch (Devicemart, Seoul, Korea) and an LED for verifying operational status.

PID control system design

To solve this problem, PID (Proportional-Integral-Derivative) control is used to control the motor speed to maintain constant tension in the cables. The control system for the timber carriage was designed with the use of a transfer function of the servomotor and PID controller. The transfer function of the motor system is shown in Equation (1). J in Equation (1) is the rotor inertia coefficient, B is the friction factor coefficient, R_a is

the armature resistance, K is the motor torque constant, K_e is back-EMF constant, and τ is a time constant, all of which are shown in Table 2. In order to control this type of motor system, the transfer function of the conventional PID controllers can be expressed as in Equation (2), and the transfer function of the timber carriage control system can be expressed as in Equation (3) (Jeon et al., 2007).

In Equation (2), $e(t)$ is the variance error between the reference input $r(t)$ and control output $u(t)$, and most controllers are designed to transmit output signals through feedback of the error signals (Choi et al., 2002). Here, K_p is the proportional gain, K_i is integral gain, and K_d is derivative gain. The improvement of the performance of PID controllers and effective control can be determined by how the K_p , K_i , and K_d values are set, and Table 3 shows the summary of roles and characteristics of these values. To set the values of the coefficients of the PID controller, the Ziegler-Nichols tuning method is used to set PID gains values. The block diagram of the entire control system can be represented as shown in Fig. 3.

Table 1. Compact FieldPoint Module Specifications

cFP-2210	Controller 400MHz, 256MB, Ethernet
cFP-AI-100	8-Channel Analog Voltage Input 30V
cFP-AO-210	8-Channel Analog Voltage Output 10V
cFP-DIO-550	Digital Voltage I/O 8-Channel 11~30VDC
cFP-RLY-421	8-channel Relay 120VDC, 250VAC

Table 2. System parameters

$K(N_m/A)$	1.251	$K_e(V \cdot \text{sec}/\text{rad})$	8.31
$R_a(\text{Ohm})$	1.30	$B(\text{kgm}^2/\text{s})$	8
$J(\text{kgm}^2)$	15.2×10^{-4}	$\tau(\text{msec})$	67

Table 3. PID controller tuning rule for the frequency response method of Ziegler-Nichols

Type of Control	K_p	K_i	K_d
Proportional	$0.5 K_{cr}$	-	-
PI	$0.45 K_{cr}$	$0.83 P_{cr}$	-
PID	$0.6 K_{cr}$	$0.5 P_{cr}$	$0.125 P_{cr}$

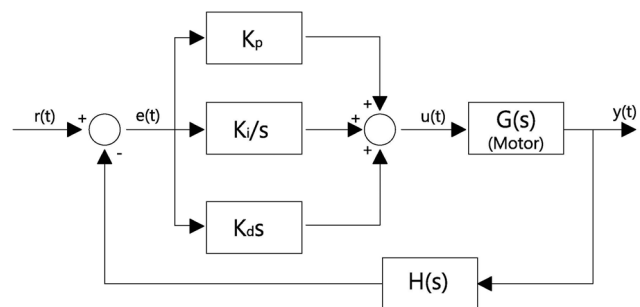

Figure 3. Block diagram of servo motor control system.

$$G(s) = \frac{K_m}{s(\tau s + 1)} \quad (1)$$

$$K_m = K / (r_a B + K K_e)$$

$$\tau = R_a J / (R_a B + K K_e)$$

$$u(t) = K_p e(t) + K_i \int_0^t e(t) d\tau + K_d \frac{de(t)}{dt} \quad (2)$$

$$G_{PID} = K_p + K_d s + K_i / s$$

$$T(s) = \frac{K_m (K_d s^2 + K_p s + K_i)}{\tau s^3 + (1 + K_m K_d) s^2 + K_m K_p s + K_m K_i} \quad (3)$$

Selection of PID controller gains

To select PID controller gains, the Ziegler-Nichols tuning method was used, which is a method that can be used even in cases where the target system has its limit value at the origin or is unstable. Of the PID controller gains in Equation (2), the values are increased from 0, by

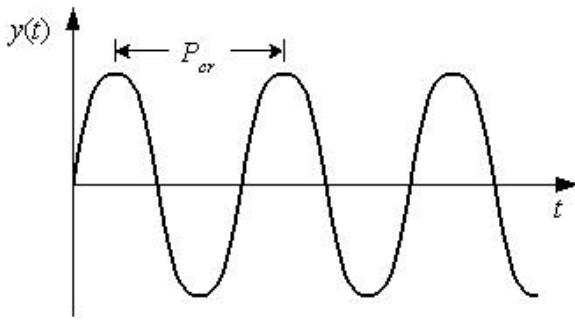

Figure 4. Ultimate period.

applying only P controller to the system with K_i set as maximum and K_d as minimum, until the critical gain K_{Cr} where the output vibrates is reached. This K_{Cr} is defined as the value of K_p when there is continuous vibration in the output as shown in Fig. 4. When K_{Cr} is obtained, the corresponding critical period of continuous vibration P_{Cr} can be obtained, and by using the formula in Table 3 the gains for K_p , K_i and K_d can be selected.

To select the best-performing PID gains P_{cr} and K_p for continuous vibration obtained through step response analysis and the control method shown in Table 3 are used to select PID initial gains (Figure 5 (a) ①). Using the initial K_p , K_i and K_d that were selected for the consideration of PID control response characteristics as the base, each gain need to be varied in accordance with a step response signal and adjusted in detail (see Figure 5 (b) ②).

The continuous vibration obtained from the step response and control technique proposed from table 3 was used to choose the PID gains (Fig. 5 (a) ①). Using continuous vibration (signal from the loadcell (N)) and the step response signal, initial PID gain could be calibrated (Fig. 5 (b) ②).

Simulation development

In order to evaluate the response characteristics of the selected optimal PID gain, a simulation block diagram was developed (Fig. 6.). The optimal PID gain was applied into both LabVIEW and Matlab Simulink v. 7.1.0 (Mathworks, Inc., 2005), and the measured data was compared with

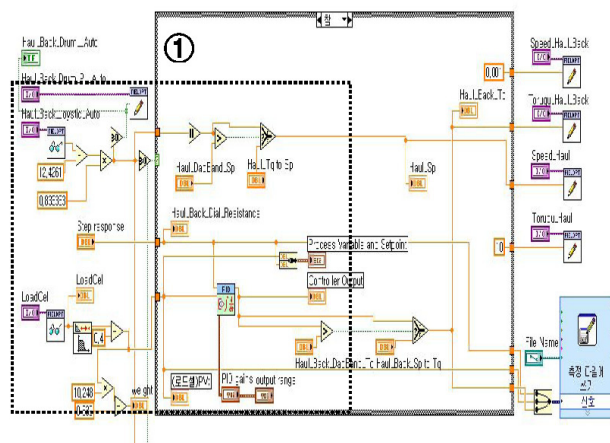

(a) Block diagram

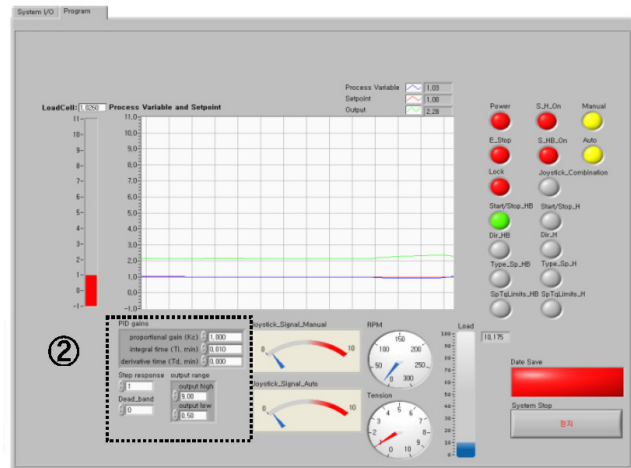

(b) Front panel

Figure 5. LabVIEW for PID control.

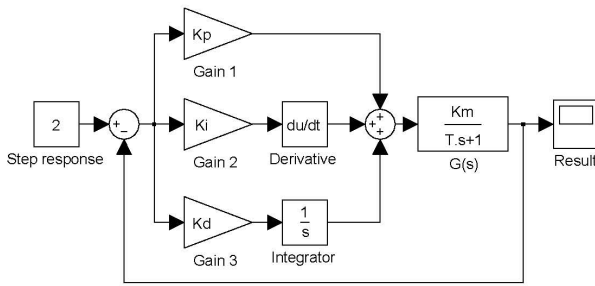

Figure 6. Block diagram.

the simulated results generated from Simulink.

Results and Discussion

Results of PID gains selection

The step response of the system with a target tension of 19.6 N was used to calculate K_{cr} and P_{cr} as 3 and 0.05, respectively. By using the Ziegler-Nichols tuning method, initial values of 1.8 for K_p , 0.025 for K_i , and 0.006 for K_d were selected. However, because significant vibrations occurred and control could not be done smoothly despite the small value of K_d , the K_d value was removed and K_p and K_i values were combined. With PI control only, the experiment was re-conducted and the result of the initial K_p and K_i values were 1.8 and 0.025. Since timber carriages transport heavy timber loads and require stability, the experiment was re-conducted with a maximum step response overshoot of 20% as the target. The initially selected K_p and K_i , (1.8 and 0.025) produced a 48% overshoot, exceeding the 20% target by 28%. To reduce this overshoot, the experiment was re-conducted with initial gains of 1.4 and 0.010, which resulted in convergence with 16% overshoot, as shown in Figure 7. The reason for the overshoot is believed to be due to the elasticity of the cable and vibrations during transport. Comparing the initial values and the values for which response characteristics were taken into consideration, the overshoot of the system decreased significantly and arrived near the target amount and the tension was maintained at a constant value.

Comparison of the simulation with the experiment results

The comparison of the simulated results given by Simulink with the experimental data through LabVIEW using the optimal PI gain from the system was performed. Fig. 8

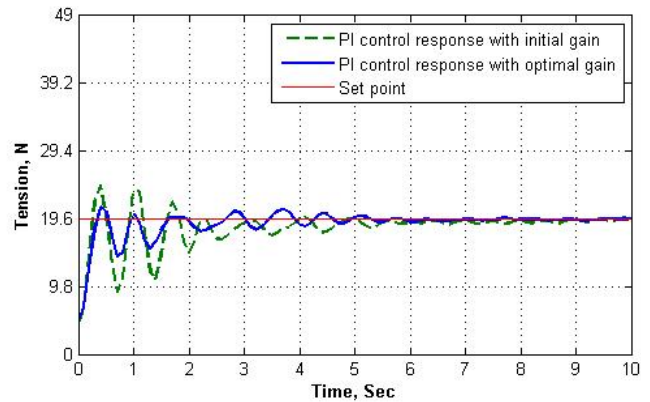

Figure 7. PI control response.

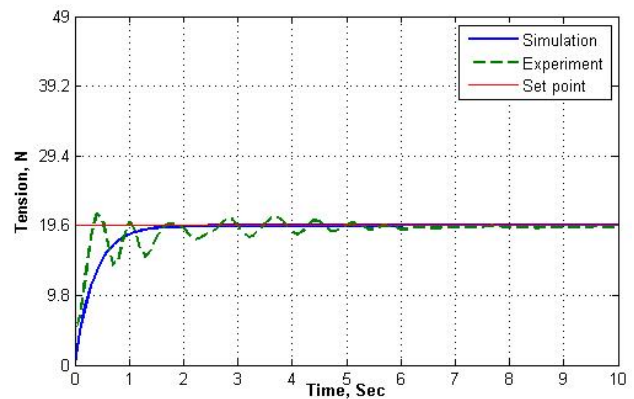

Figure 8. Comparison of the simulation with the experiment results.

shows the comparison of the two results. The rising time was faster in the test result than in simulation, and in arriving at the target amount the two response forms showed a difference. The reason for this is thought to be due to the elasticity of the cable and vibration during the transport of timber.

Results and comparison in accordance with changes in tension

To verify changes in tension in this system, after equalizing the number of wire (cable) windings and the diameters of the drums installed in each motor, tensions were measured without PI control. The rotational speeds of the two motors were equalized to 150 rpm. In order to maintain stability, a maximum high speed of 150 rpm was selected. Since the servomotors are not capable of speed and torque operation simultaneously, operation was conducted without any load in the timber carriage. It was possible to observe that as each motor started operating, the drum diameter starting to change, and during the first

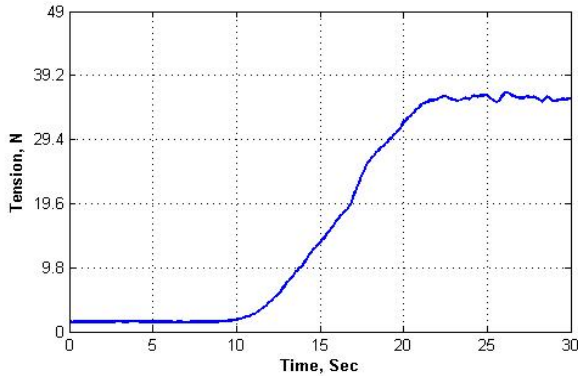

Figure 9. Loadcell response without PI control.

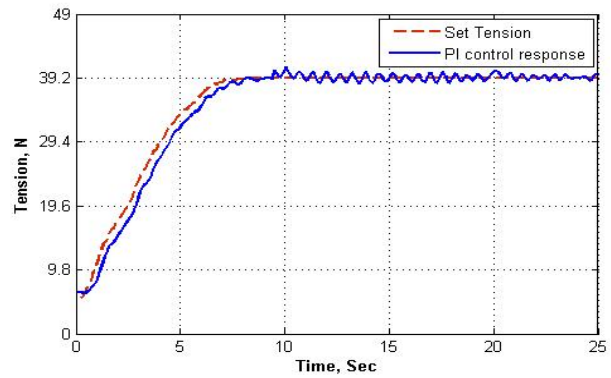

Figure 11. Tension response using PI control under 150 rpm of the motor speed and timber weight of 9.8 N.



Figure 10. Loaded timber Carriage traveling experiment.

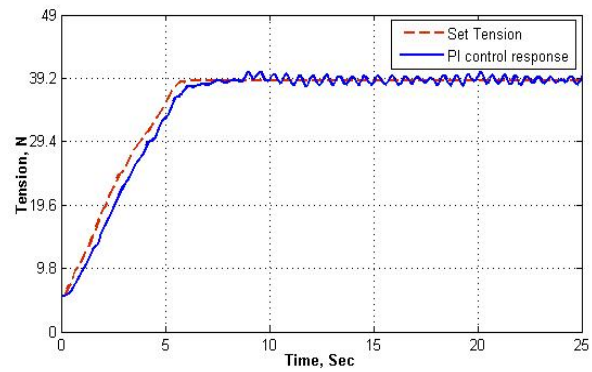

Figure 12. Tension response using PI control under 150 rpm of the motor speed and timber weight of 29.4 N.

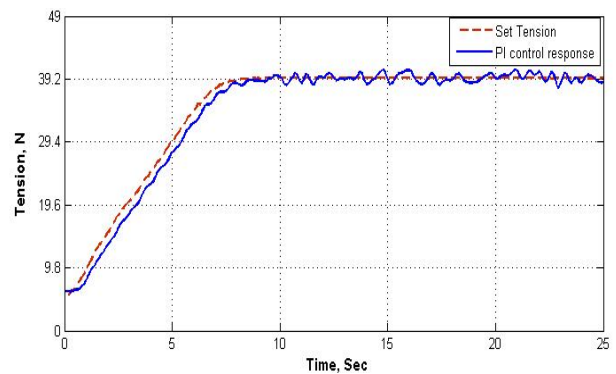

Figure 13. Tension response using PI control under 150 rpm of the motor speed and timber weight of 49 N.

10 seconds, there was no response to tension. At the 20-second mark, the tension gradually started to increase (Figure 9). Thereafter, despite the differences in the diameters of the drums, tension was still constant, and this was found to be caused by the fact that since the haul-back motor's capacity was greater than that of the haul motor, the load on the haul-back motor pulled the haul motor. The haul motor's rotational speed increased over the input signal, and the tension remained constant for a finite duration.

An experiment in maintaining constant tension during motor operation using PI control was conducted as well. Using the final selected PI gains, 9.8, 29.4, and 49 N loads of timber were loaded onto the carriage. Rotational speeds of the motors were set at 150 rpm, the transport distance set at 12 m, and afterwards, tension was gradually increased manually to allow pulling of the timber by maintaining constant tension. With the tension set 39.2 N

and within the 20% maximum overshoot, the timber was transported while maintaining constant tension by controlling the rotational speed (Figures 11, 12, 13). The maximum overshoots for each case were 11, 8, 10% with the timber weight of 9.8, 29.4, 49 N respectively, which were reduced approximately 38% compared with initial PI value. The fluctuation seen in Figures 11, 12 and 13 is,

as described above, caused by the vibration, which occurred while the wire was being wound up on the drum, affecting the load cells. The results obtained by experimentation using these two methods showed that using PI control it is possible to maintain constant wire tension during the operation of timber carriages.

Conclusions

By utilizing servomotors and a PID controller, a system that can maintain constant tension in a timber carriage wire was implemented. To implement the PID controller effectively, LabVIEW8.5 code was developed, and by applying the Ziegler-Nichols tuning method for calculating PID controller gains, 1.4 and 0.010 were selected as the respective proportional and integral gains that produced convergence within the designated maximum overshoot of 20%. In reality, based on the result of the timber carriage experiment, it was confirmed that tension was maintained constant with only the use of PI control. Due to the vibration that occurs from the timber carriage load and the elasticity in the wire, the simulation result and test data using PI gains showed a difference but the obtained values were very similar. Using the result of this experiment as the base, research on the design of a controller that takes into consideration safety and vibration and obtaining system reliability needs to be pursued, and a timber carriage capable of being used in practical situations on a farm scale would need to be developed.

Conflict of Interest

No potential conflict of interest relevant to this article was reported.

Acknowledgement

This Study was supported by Technology Development

Program for Agriculture and Forestry, Ministry for Food, Agriculture, Forestry and Fisheries, Republic of Korea.

References

- Anderson, W. R. 1988. Controlling Electrohydraulic System. Marcel Dekker, New York, N.Y. USA.
- Astrom, K. J. and T. Hangglund, 1984. Automatic tuning of simple regulators with specifications on phase and amplitude margins. *Automatica* 20:645-652.
- Astrom, K. J. and T. Hangglund. 1995. PID Controllers : Theory, Design and Tuning. Inst. Society of America.
- Choi, H. D., D. H. Lee, S. Y. Ha, U. C. Jeon and J. W. Kim. 2003. Controller Design of DC Servo Motor Using Ziegler-Nichols Auto-Tuning Method. *Korean Society for Precision Engineering* pp.988-991 (In Korean).
- Choi, H. D., J. H. Kim and J. W. Kim. 2002. The control of DC Servo Motor Applying High-speed Design System. *Korean Society for Precision Engineering* pp.675-678 (In Korean).
- Jeon, C. S., D. S. Kim and J. M. Lee. 2007. PID gain auto tuning of ETB by using RLS. *Journal of Korea Robotics Society* 2(1):1-8 (In Korean).
- Kim, D. C., J. K. Lee, D. H. Kim and B. S. Shin. 2009. Positon Control System of a Double-end Rod Hydraulic Cylinder under Variable Flow Rate and Load Conditions. *Journal. Of Biosystems Engineering* 34(5):331-341 (In Korean).
- Kim, G. Y., Y. H. Kim, C. Y. Mo, K. J. Lee, K. M. Yang and H. K. Kim 2009. Development of a Temperature Controller for Microwave-assisted Digestion System for Agricultural Samples. *Journal. of Biosystems Engineering* 34(5): 371-376 (In Korean).
- Kim, J. K., Y. S. Mo, G. Y. Ryu, S. H. Hwang and Y. W. Yoon. 1999. Z-N Tuning Development for PID Controller and Its Application (In Korean).
- Kim, Y. J., Y. K. Choi, K. C. Lee, Y. S. Ryu, K. H. Ryuh and J. H. YU. 2009. Development of 1-axis Exciter for a Seat Vibration Test of Agricultural Tractors (I). *Journal. of Biosystems Engineering* 34(5):305-314 (In Korean).