

Analytical Methods of Levoglucosan, a Tracer for Cellulose in Biomass Burning, by Four Different Techniques

Min-Suk Bae*, Ji Yi Lee¹⁾, Yong-Pyo Kim²⁾, Min-Ho Oak³⁾, Ju-Seon Shin⁴⁾, Kwang-Yul Lee⁴⁾, Hyunhee Lee⁵⁾, Sun Young Lee⁵⁾ and Young-Joon Kim⁴⁾

Department of Environmental Engineering, Mokpo National University, Jeollanamdo, Korea

¹⁾Department of Environmental Engineering, BK21 Team for Biohydrogen Production, Chosun University, Gwangju, Korea

²⁾Department of Environmental Science and Engineering, Ewha Womans University, Seoul, Korea

³⁾College of Pharmacy, Mokpo National University, Jeollanamdo, Korea

⁴⁾Department of Environmental Engineering, Gwangju Institute of Science and Technology, Gwangju, Korea

⁵⁾Department of environmental health, Seoul National University, Seoul, Korea

*Corresponding author. Tel: +82-61-450-2485, Fax: +82-61-452-8762, E-mail: minsbae@hotmail.com

ABSTRACT

A comparison of analytical approaches for Levoglucosan ($C_6H_{10}O_5$, commonly formed from the pyrolysis of carbohydrates such as cellulose) and used for a molecular marker in biomass burning is made between the four different analytical systems. 1) Spectrothermography technique as the evaluation of thermograms of carbon using Elemental Carbon & Organic Carbon Analyzer, 2) mass spectrometry technique using Gas Chromatography/mass spectrometer (GC/MS), 3) Aerosol Mass Spectrometer (AMS) for the identification of the particle size distribution and chemical composition, and 4) two dimensional Gas Chromatography with Time of Flight mass spectrometry (GC×GC-TOFMS) for defining the signature of Levoglucosan in terms of chemical analytical process. First, a Spectrothermography, which is defined as the graphical representation of the carbon, can be measured as a function of temperature during the thermal separation process and spectrothermographic analysis. GC/MS can detect mass fragment ions of Levoglucosan characterized by its base peak at m/z 60, 73 in mass fragment-grams by methylation and m/z 217, 204 by trimethylsilyl derivatives (TMS-derivatives). AMS can be used to analyze the base peak at m/z 60.021, 73.029 in mass fragment-grams with a multiple-peak Gaussian curve fit algorithm. In the analysis of TMS derivatives by GC×GC-TOFMS, it can detect m/z 73 as the base ion for the identification of Levoglucosan. It can also observe m/z 217 and 204 with existence of m/z 333. Although the ratios of m/z 217 and m/z 204 to the base ion (m/z 73) in the mass spectrum of GC×GC-TOFMS lower than those of GC/MS, Levoglucosan can be separated and characterized from D(-)+Ribose in the mixture of sugar compounds. At last, the environmental sig-

nificance of Levoglucosan will be discussed with respect to the health effect to offer important opportunities for clinical and potential epidemiological research for reducing incidence of cardiovascular and respiratory diseases.

Key words: Levoglucosan, Organic molecular marker, ECOC, AMS, GC×GC-TOFMS, GC/MS

1. INTRODUCTION

Atmospheric aerosols include substantially large amounts of organic compounds. Although every organic molecular structure is not completely understood, it is very clear that these organic compounds can enhance the ability to scatter or absorb incoming solar radiation, resulting the change of earth's albedo and visibility impairments (Levine, 1996, 1991; Lobert *et al.*, 1990; Crutzen *et al.*, 1985).

Studying the composition of the organic chemical compounds in atmospheric aerosols has been challenging for several decades. Although years of effort with the use of the most sophisticated techniques (such as Aerosol Mass Spectrometer (AMS), Chemical Ionization (CI), Electron Attachment (EA), Elemental Carbon Organic Carbon (ECOC), Fourier Transform Infrared Spectroscopy (FTIR), Gas Chromatography/mass spectrometer (GC/MS), Time of Flight (TOF) mass spectrometry by two dimensional Gas Chromatography (GC×GC-TOFMS), High Resolution time of flight Aerosol Mass Spectrometer (HR-Tof-AMS), Nuclear Magnetic Resonance (NMR), Particle Beam Thermal Desorption Mass Spectrometer (PBTDMs), Particle-into-liquid-sampler for OC (PILS-OC), and Vacuum Ultraviolet (VUV)), only about 10 to 40% of mass ratio in the particulate organic matter has been found

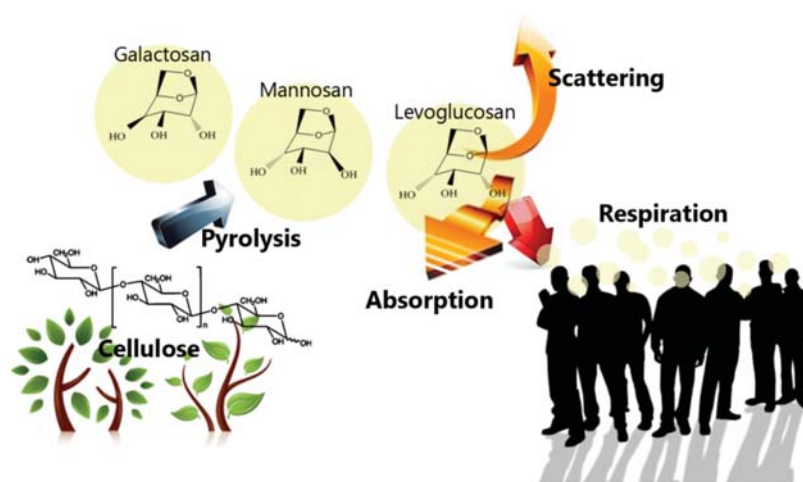

Fig. 1. Route of Levoglucosan in ambient aerosols throughout pyrolysis & optical properties to respiration of human beings.

as specific organic markers (Schauer and Cass, 2000; Schauer *et al.*, 1996).

However, the identification of specific organic compounds as molecular marker could be the only way to understand the detailed chemical structure related to primary/secondary organic containing sources. This implies that typically the composition of the material in atmospheric aerosols can be characterized with a company with a source apportionment model such as Chemical Mass Balance (CMB) model or Positive Matrix Factorization (PMF) model. The source emission profiles is available to calculate the organic source apportionment model obtained from previous source testing efforts that used the analytical methods for source profiling of diesel trucks, gasoline-powered cars, smoking vehicles, wood smoke, road dust, vegetative detritus, and natural gas combustion (Bae *et al.*, 2006). Although, many organic compounds in atmospheric particulate matter have been researched as molecular markers, the ratio of the molecular markers in specific organic compounds can be different due to the differences in original source materials from region to region. Therefore, it is of prior importance to start to develop and analyze the detailed organic molecular markers.

Biomass burning can be a starting point to search for the known organic molecular marker related to a source due to its high potential contributor into the atmosphere. The biomass types, which were burned, are comprised of soft woods, hard woods, and grasses from temperate, tropical and arctic climate areas, respectively, with cellulose as reference material. The key molecular marker related to the biomass burning source is Levoglucosan, which can be formed as the derivative from the thermal breakdown of cellulose during burning

processes. It can be finally used as the tracer compounds. Again, unlike other indicators used for the purpose of finding the sources, the Levoglucosan can be used as a source-specific to burning of any fuel containing cellulose (Fig. 1). Briefly, it is important that combustion of other materials or biodegradation and hydrolysis of cellulose does not produce Levoglucosan. Only when cellulose is heated over 300°C, a highly combustible tar can be produced, a major constituent of which is Levoglucosan, a dehydrated glucose containing a ketal functional group (Shafidazeh, 1984). In addition, as the aspect of 'chemical structure stability', which means that it should not be formed or not be destroyed through atmospheric chemical reactions during transport, Levoglucosan is certainly a qualified organic compound as an organic molecular tracer.

In the United States, the wood smoke in fireplaces, which is one of the major sources, can be including Levoglucosan as a molecular marker of biomass burning, polycyclic aromatic hydrocarbons (PAHs), aldehydes, and free radicals. Those chemicals are very toxic or mutagenic. Several studies have reported associations between wood smoke exposure and adverse health effects including eye, nose, and throat irritation, decrements in lung function, and increased respiratory infections (Ezzati and Kammen, 2001; Smith, 2000; Brauer and Hisham-Hashim, 1998; Larson and Koenig, 1994). In Korea, vegetation burning in fall season after harvest, which contains primarily biopolymers with minor amounts of lipids and terpenoids, can be one of the major sources for biomass burning. Unfortunately, there is no data available analyzed in Korea due to the limitation of analytical technique in organic molecular markers. Therefore, it is very clear that ana-

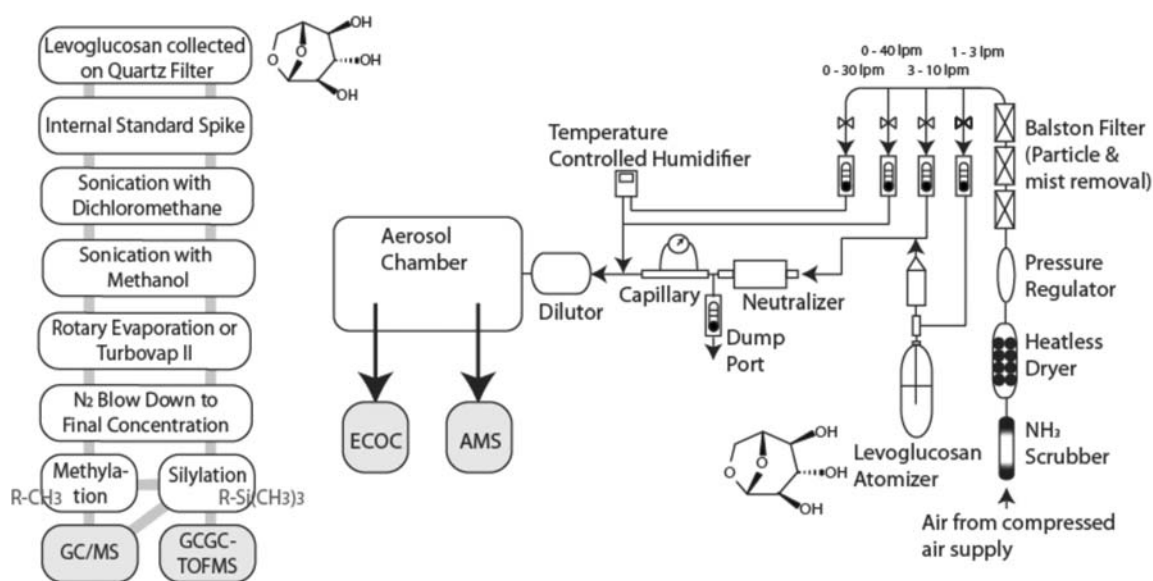

Fig. 2. Schematic diagram of the aerosol generation system and extraction procedure for Levoglucosan analysis.

lytical technologies are needed and developed.

This study provides the detailed technical for the analysis of Levoglucosan by (1) Elemental Carbon & Organic Carbon (ECOC), (2) Gas Chromatography Mass Spectrometry (GC/MS), (3) Aerosol Mass Spectrometer (AMS), and (4) Time of Flight (TOF) mass spectrometry by two dimensional Gas Chromatography (GC \times GC-TOFMS). One of the primary objectives of this study is (1) to evaluate the detection of Levoglucosan, then (2) to provide the detailed analytical techniques by four different measurement approaches, (3) and demonstrate their potential operation robustness for routine monitoring applications related to biomass burning sources.

2. ANALYTICAL METHODS OF LEVOGLUCOSAN

2.1 Elemental Carbon & Organic Carbon Analyzer (ECOC Analyzer)

To analyze Levoglucosan using ECOC analyzer and AMS, the aerosol generation system is designed and operated. A schematic of the generation system for aerosols is shown in Fig. 2. Briefly, one of the aerosol-generation instruments utilized is a constant output atomizer (TSI Model 3076) operating in the recirculation mode. Droplets are produced by atomizing a solution of Levoglucosan. The generated aerosol is mixed with a dry airflow, which leads to its dilution and partial evaporation of the solution. A dry airflow can be generated under the condition throughout NH_3

scrubber, heatless dryer, balston filter controlled by pressure regulator. The aerosol passes through an aerosol neutralizer (TSI Model 3054, USA) following by a dilution capillary, and then enters a dilution chamber system. Finally, Levoglucosan as suspended organic aerosols can be collected by ECOC analyzer and AMS without any contaminations.

First, to analyze Levoglucosan, Sunset Laboratory's semicontinuous OC and EC instrument, so called ECOC analyzer (the thermal-optical ECOC analyzer, Sunset Laboratory Inc., Forest Grove, OR), has been utilized as a field deployable alternative to integrated filter collection with subsequent laboratory analysis (Bae *et al.*, 2004). ECOC analyzer can determine the amounts of organic carbon (OC) and elemental carbon (EC). This instrument can provide time-resolved OC and EC analyses on a semicontinuous basis, comparable to the recognized NIOSH (National Institute for Occupational Safety and Health) Protocol 5040.

Briefly, a quartz filter punch is mounted in the instrument then samples are collected on this filter for the desired time period. In this study, the semicontinuous sampler was operated with a 1 hour cycle time including a sample analysis period. Although the current chamber study did not require the organic denuder, the denuder for volatile organic gases was fabricated with replaceable parallel charcoal-impregnated filter strips to collect gas phase organic compounds that could absorb on the surface of the collected aerosol or adsorb onto the quartz fiber filter (Mader *et al.*, 2003).

Fig. 3 shows simplified block diagram for the Sunset Laboratory semicontinuous ECOC field analyzer. OC

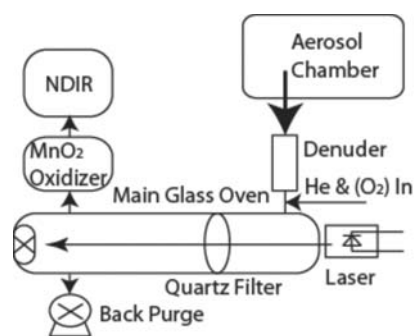

Fig. 3. Simplified block diagram for the Sunset Laboratory semi-continuous ECOC analyzer.

and EC were determined as follows: OC was evolved under a stream of ultrahigh purity He (99.99% minimum) while heating the sample in four temperature steps to a final temperature of 870°C after gradually increasing temperature. EC and pyrolyzed OC were evolved under a mixture of 2% O₂ following by 98% He in four temperature steps. The analyzer utilized laser transmission to correct for sample pyrolysis.

To investigate chemical specific carbon thermal pattern using ECOC analyzer, Spectrothermography, is a conventional method for classifying carbonaceous aerosols as organic carbon and elemental carbon based on thermal evolution with differences in particle thermal characteristics, that will be discussed.

2.2 Gas Chromatography Mass Spectrometry

2.2.1 Extraction of Levoglucosan in Ambient Sample

Several different techniques such as sonication, soxhlet, and an automated system of Accelerated Solvent Extraction (ASE) are available to extract the organic aerosol including Levoglucosan from the filter after organic containing sample collections using a high volume air sampler.

As a method using sonication extraction, the methods and procedures for the organic speciation have been previously reported (Bae *et al.*, 2006). The samples, which collected by high volume sampler, were sonicated two times with 30 mL of high purity dichloromethane (DCM) and then were sonicated twice with 30 mL of high purity methanol in each jar. The extracts were concentrated in volume to approximately five mL using a vacuum rotary evaporator. The PTFE filtered samples were reduced in volume using nitrogen blow down to a final volume that yielded a final concentration of the internal standard of Levoglucosan-U-13C6 (carbon 13 uniform labeled compound) in the extract equivalent to the internal standard spike and the internal standard concentrations in the quanti-

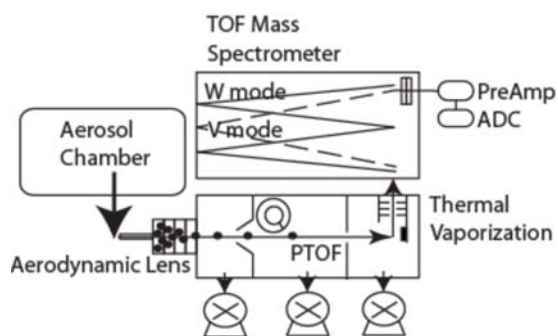

Fig. 4. Simplified block diagram for Aerosol Mass Spectrometer.

fication standards. The final extract volume was methylated using diazomethane (1-methyl-3-nitro-1-nitrosoguanidine, MNNG). It can be also reacted with silylation reagent to derivatize Levoglucosan to their trimethylsilyl derivatives (TMS-derivatives). After the methylation or TMS-derivation, the samples were reconcentrated to the pre-derivatization final volume.

2.2.2 Gas Chromatography Mass Spectrometer

The same GC/MS protocols were used for the analysis of the methylated and silylated extracts using a 5MS GC column (ultra low bleed 5%-diphenyl, 95%-dimethylsiloxane copolymer). The GC oven was heated using the following program: isothermal at 65°C for 10 min, 4 min⁻¹ to 300°C, and isothermal for 41.5 min with He as carrier gas. Levoglucosan is typically characterized by its base peak at m/z 60, 73 in mass fragment-grams. The mass spectrum of internal Levoglucosan standard (Levoglucosan-U-13C6) exhibits a molecular ion (m/z 62, 76) with fragments. The abundance of m/z 217, 204 by the mass spectrum of TMS-derivatives can be characterized for the distinction of Levoglucosan as well. The analyzed concentrations using GC/MS will be discussed.

2.3 Aerosol Mass Spectrometer (AMS)

Using the aerosol generation system, AMS can produce mass spectrum related to Levoglucosan. A comprehensive description of AMS and its principles of operation can be found elsewhere (Jayne *et al.*, 2000). Briefly, AMS consists of three pumped chambers as shown in Fig. 4 (an aerosol sampling chamber with an aerodynamic lens) and can be operated in two modes (V-mode and W-mode). Levoglucosan particles impact on a 600°C heater surface, where volatile and semivolatile particle components evaporate. The vapor is ionized by electron impact, and ions are analyzed with a mass spectrometer.

The detailed ion compositions for Levoglucosan from the chamber can be analyzed using the standard

AMS data analysis software written in Igor Pro (Wave-metrics, Lake Oswego, OR). A collection efficiency (CE) of 0.5 was used to account for the incomplete detection of aerosol species due to particle bounce at the vaporizer and/or partial transmission of particles by the lens. Relative ionization efficiencies (RIEs) of 1.4 for organics were used. The W-mode in AMS was analyzed to see the detailed Levoglucosan spectra, which is analyzed to determine the elemental compositions of ion fragments.

2.4 Two Dimensional Gas Chromatography with Time of Flight Mass Spectrometry (GC × GC-TOFMS)

The Levoglucosan also can be detected by a LECO Pegasus 4D 2GC TOFMS (LECO, St. Joseph, MI, USA). This instrument comprised an Agilent 6890 gas chromatograph equipped with a secondary oven, a split/splitless injector, and time of flight mass spectrometer (TOFMS). The injector was operated in splitless mode at 300°C. Helium (BIP grade from Linde, Canada) was used as the carrier gas in constant flow mode with a flow rate of 1.3 mL min⁻¹. The order of columns in the GC × GC was; first column: 30 m DB-5MS (0.25 mm OD, 0.25 μm film), second column: 1.17 m DB-17MS (0.18 mm OD, 0.18 μm film). The detailed analytical conditions can be found elsewhere (Lee and Lane, 2010; Lee and Lane, 2009).

The oven temperature was started at 60°C for 1.0 min; programmed at 6°C min⁻¹ up to 290°C and held there for 15.0 minutes. The secondary oven offset was 10°C above the main oven and the modulator temperature offset relative to the GC was +25°C. Modulation was performed with a liquid nitrogen cooling cryogenic dual-jet N₂ modulator with a cool time of 1.40 second between cooling and heating stages. The interface between the GC × GC-TOFMS system was maintained at 300°C with the ion source at 225°C.

Mass scans from 40 to 550 daltons were carried out at a rate of 200 full spectra per second. LECO Chroma TOF software (version 3.32) was used for data acquisition processing and analysis of Levoglucosan. Table 2 shows the summary of analytical characteristics for the study.

3. TECHNICAL DISCUSSIONS AND ANALYTICAL RESULTS

3.1 Spectrothermography by ECOC Analyzer

Although ambient aerosol particle are formed and evolve through a complex sequence of chemical processes, thermal-optical evolve gas analysis, so called Spectrothermography, is a conventional method for classifying carbonaceous aerosols as organic carbon

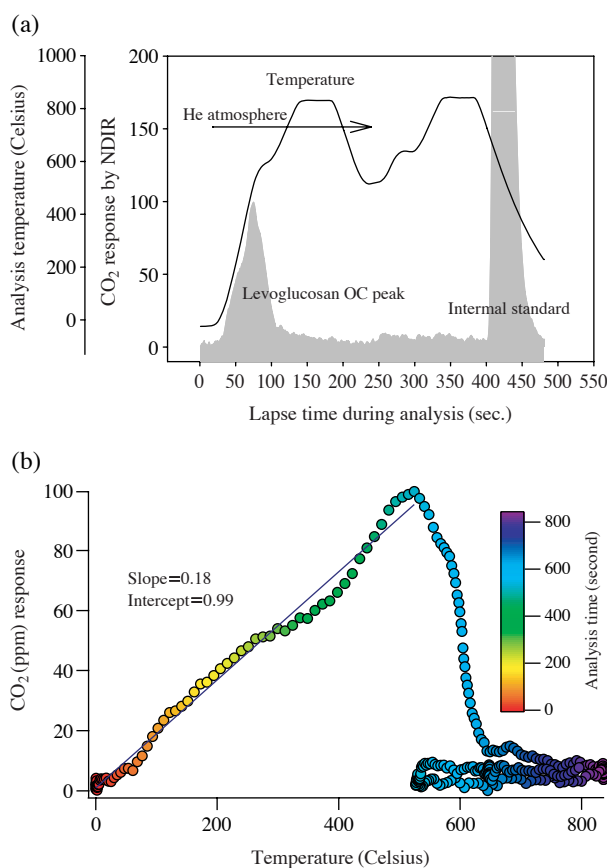

Fig. 5. (a) Spectrothermography of Levoglucosan analyzed by Elemental Carbon & Organic Carbon Analyzer (ECOC Analyzer) and (b) relationship between CO₂ response and operational temperature protocol colored by analysis lapse time.

and elemental carbon. It can define as the evaluation of thermograms of carbon evolved from heated aerosol samples, is a technique evaluating differences in particle characteristics as they related to emission sources such as biomass burning and car emission. Spectrothermographic analysis can be one technique that provides the potential relationships between thermogram shapes and sources. Fig. 5(a) shows that Spectrothermography for Levoglucosan, which can be used as a biomass category. This Spectrothermography suggests that there are unique patterns contained in the shapes of the thermograms derived from evolved gas analysis of Levoglucosan, that spectrothermographic analysis of these patterns could reveal more information about the biomass burning from the bulk organic carbon and elemental carbon thermal analysis.

In detail, a thermogram is defined here as the graphical representation of the carbon that is measured as a function of temperature during the thermal separation process and spectrothermographic analysis is the eval-

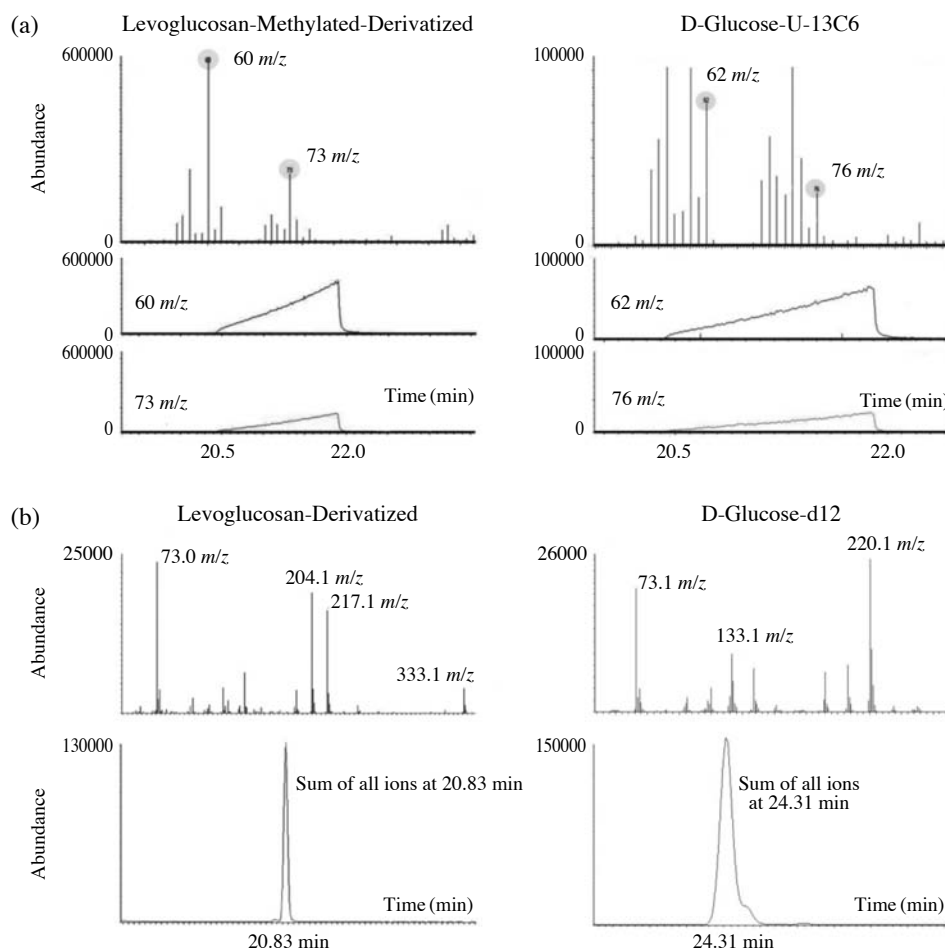

Fig. 6. (a) Mass fragment ions (m/z) by GC/MS for Levoglucosan-Methylated and (b) Mass fragment ions (m/z) for Levoglucosan-Methylated TMS-derivatives.

uation of the shape of the thermogram. The amount and shape of spectrothermogram presentation has been determined by internal standard gas.

As shown in Fig. 5(a), the temperature of the first peak has the first maxima at 525°C. It can be seen that the spectrothermogram has only the slightest suggestion of a secondary peak as a shoulder on the left tail of the first peak. Although an S-shape curve is shown in relationship between CO₂ response and Temperature in Fig. 5(b) colored by analysis lapse time, the comparison of CO₂ response and temperature indicates slope of 0.18, which could apply for the overall speed of carbon-evolution related to biomass identification. This value can be utilized for the ambient aerosol originations.

3.2 Gas Chromatography Mass Spectrometry (GC/MS)

Levoglucosan and other minor monosaccharide derivatives are present in smoke samples, can be ana-

lyzed by GC/MS. GC/MS can scan mass fragment ions typically up to m/z 500 based on operation conditions. When methylation is applied, it is found that Levoglucosan is a major component and is typically characterized by its base peak at m/z 60, 73 in mass fragment-grams (Fig. 6(a)). The mass spectrum of internal standard (Levoglucosan-U-13C6) of Levoglucosan exhibits a molecular ion (m/z 62, 76) with fragments. The mass fragment-grams of Levoglucosan presents the very broad peak but has a long tail on the left side about between 20.5 min and 22.0 min during analysis in lapse time. Although the identified fragment-grams are not usual compared to the other organic standard molecular markers (sharp & narrow), the peak can be easily identified by not only mass fragment-grams but also mass spectrum. The mass fragment-grams, m/z 62, 76 of Levoglucosan-U-13C6 indicate very similar patterns as Levoglucosan at maxima at 21.8 min. Both Levoglucosan and Levoglucosan-U-13C6 present about 35% of the second mass fragment-grams in m/z 73, 76

compared to the first mass fragment-grams in m/z 60, 62.

In the mass spectrum of Levoglucosan-TMS-derivatives by GC-MS, the base ion is m/z 73 and the major fragment ions are m/z 204 with $C_7H_{18}OSi_2$ (Simpson *et al.*, 2004), m/z 378 with fragments due to loss of CH_3 (m/z 363), CH_3Si (m/z 333), and $C_6H_{17}OSi_2$ (m/z 217) (Abas *et al.*, 2004; Pashynska *et al.*, 2002) (Fig. 6(b)). The larger abundance of m/z 217 than m/z 204 in the mass spectrum of Levoglucosan-TMS-derivatives can be used for the distinction of Levoglucosan and D(-)+Ribose in the mixture of sugar compounds. The data in Table 3 are purposed on comparison of location, type of region, season, sampling method, analytical method, concentration, organic carbon, and elemental carbon concentration with related source references. This summary is of importance to understand the base level of absolute mass concentrations with analytical conditions related to regional Levoglucosan in ambient as the major compound in smoke from burning the cellulose.

3.3 Aerosol Mass Spectrometer (AMS)

Over a past decade, a number of semicontinuous sampling techniques to analyze ambient organic aerosol including AMS (Jayne *et al.*, 2000) have been developed. The aerosol through an aerodynamic lens in AMS, after which nonrefractory aerosol components are vaporized at 600°C with impact on a heater, followed by 70 eV electron impact ionization of the vapor and mass analysis by a mass spectrometer. This technique provides sensitive and quantitative analysis (although typically the Particle-into-Liquid Sampler-Ion Chromatography (PILS-IC) and the Differential Mobility Analyzers (DMA) are required to have a correction efficiency) of both aerosol composition and size dis-

tributions. One of the most benefits of AMS presents that the size distributions of speciated aerosol mass are determined from a subset of m/z using a particle time-of-flight (pTOF) measurement technique. The fragments most often selected for size distribution measurement in the pTOF mode are: m/z 16 (NH_2^+ ; ammonium); m/z 18 (H_2O^+ ; particulate water); m/z 28 (N_2^+ from nitrogen air and CO^+ from particulate oxygenated organic); m/z 30 and/or 46 (NO^+ , NO_2^+ ; nitrate); m/z 32 (O_2^+ ; air); m/z 48 and 64 (SO^+ , SO_2^+ ; sulfate); and m/z 43, 44, 55, 57 (organic fragments). The organic ions are associated with several types of organics including mass spectral markers for hydrocarbon-like (m/z 57) and oxygenated (m/z 44) organics to identify the primary and secondary organic originations. They are chosen because they are frequently the most prominent masses in the organic fraction of the mass spectrum.

However, AMS has a limitation to detect the single organic compound due to its m/z separation in analysis. With an importance of natural hydrocarbons contributor to PM organic fraction in rural and urban environments, to avoid the current limitation, the researchers were trying to find the PM organic carbon characterization using AMS to study physical and chemical properties of laboratory-generated oxygenated organic aerosols of known composition and of ambient importance and/or to develop characteristic high-resolution mass spectra for compound-specific PM products. Information obtained in this study can be further used to quantify the AMS-measured organic mass fraction of $PM_{2.5}$ made in urban and rural environment.

Briefly, organic aerosols were generated by a spray-atomization in solvent as described previously. Table 1 presents the scanned ion compositions related to the AMS mass fragments between m/z 60 and 60.0687, and between m/z 73.0078 and m/z 73.0891. Many oth-

Table 1. Ion Compositions analyzed from AMS.

Ion Composition	m/z 60.0000-60.0687	Ion composition	m/z 73.0078-73.0891
C_5	60.0000	C_6H_1	73.0078
$C_1H_4O_1Si_1S_1$	60.0031	$C_2H_4N_1P_1$	73.0081
$C_2H_4S_1$	60.0034	$C_2H_5O_1Si_1$	73.0110
$C_2H_5P_1$	60.0129	$C_3H_5S_1$	73.0112
$C_2H_4O_2$	60.0211	$C_2H_3O_2N_1$	73.0164
$C_1H_4O_1N_2$	60.0324	$C_3H_6P_1$	73.0207
H_4N_4	60.0436	$C_1H_3O_1N_3$	73.0276
$C_2H_6N_1O_1$	60.0449	$C_3H_5O_2$	73.0290
$C_3H_8O_1$	60.0575	H_3N_5	73.0388
$C_2H_8N_2$	60.0687	$C_2H_5N_2O_1$	73.0402
		$C_4H_6F_1$	73.0454
		$C_3H_9Si_1$	73.0474
		$C_3H_7O_1N_1$	73.0528
		$C_2H_7N_3$	73.064
		$C_4H_9O_1$	73.0653
		$C_4H_{11}N_1$	73.0891

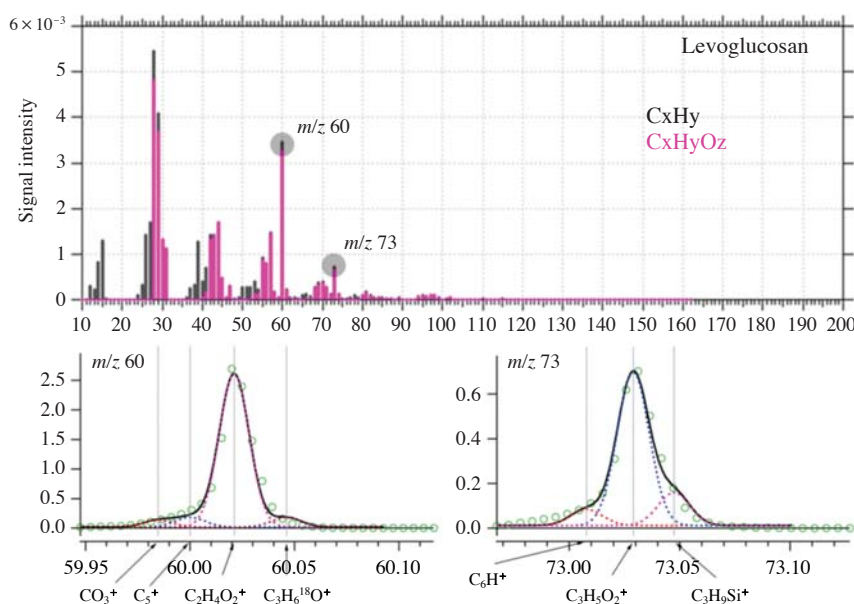

Fig. 7. Mass fragment ions (m/z) of 60 and 73 by AMS for Levoglucosan.

er ion compositions such as $C_2H_4S_1$, $C_2H_5P_1$, $C_2H_4O_2$, and $C_1H_4O_1N_2$ can be found a range of m/z 60.0034 to m/z 60.0324 and $C_3H_6P_1$, $C_1H_3O_1N_3$, $C_3H_5O_2$, and H_3N_5 a range of m/z 73.0207 to 73.0388. The major fragments can be found in m/z 60.0211 ($C_2H_4O_2$) and m/z 73.0290 ($C_3H_5O_2$).

As seen in Fig. 7, the base peak at m/z 60.0211, 73.0290 in mass fragment-grams as same as GC/MS. A multiple-peak Gaussian curve fit algorithm was used to deconvolve a unit mass peak into separate contributions for specific elemental compositions based on small differences in mass defect. Note that Criteria for “major” m/z selection: signal intensity $\geq 3\%$ of total ‘Organics’ signal.

This result can apply for ambient organic compounds of known composition and commonly found in the ambient were used to generate polydisperse aerosols. Optimal parameters for polydisperse aerosol generation and conditioning can be found; (1) Physical and chemical characterization of biomass burning aerosol can be performed; (2) Characteristic mass spectra for biomass burning can be developed; (3) Major m/z peaks for biomass burning molecular markers can be identified; and (4) Results of the High Resolution mass spectrometric analysis are consistent with expectations based on chemical structure of Levoglucosan.

3.4 Two Dimensional Gas Chromatography with Time of Flight Mass Spectrometry (GC \times GC-TOFMS)

The greatly enhanced resolution capabilities of com-

prehensive gas chromatography (GC \times GC), makes it particularly useful for the analysis of complex ambient particulate matter (PM) sample. In the GC \times GC technique, two chromatographic columns, which have different physicochemical characteristics, are coupled by an interface. Each component of a mixture undergoes two independent orthogonal separations enabling increased resolution over single dimensional chromatography. This is a significant advantage to separate completely co-eluting compounds which commonly occur in normal GC system. The coupling of GC \times GC with a time-of-flight mass spectrometer (TOFMS) has proved most useful in the identification of components in complex samples due to the high resolution of mass spectrum (200 full spectra per second) by TOFMS.

Fig. 8 shows the mass spectrum of Levoglucosan-TMS-derivatives by GC \times GC-TOFMS. As shown in the mass spectrum of GC-MS in Fig. 6(a), the base ion is m/z 73 and m/z 204, 217, and 333 can be identified. It is interesting that the distribution patterns of each fragment ion in the mass spectrum of GC \times GC-TOFMS are different from the analytical results of GC/MS. The each ratio of m/z 204 and m/z 217 to the base ion of m/z 73 of GC \times GC-TOFMS presents 0.16 and 0.14, respectively. Compared with GC/MS, these ratios show about 4.7 times lower than the ratios of m/z 204 (~ 0.76) and m/z 217 (~ 0.64) to the base ion in GC/MS. Although the disparate distribution in mass spectra of GC \times GC-TOFMS compared to GC/MS, the identification of m/z 217 and m/z 204 with existence of m/z 333 in the mass spectrum can be clearly

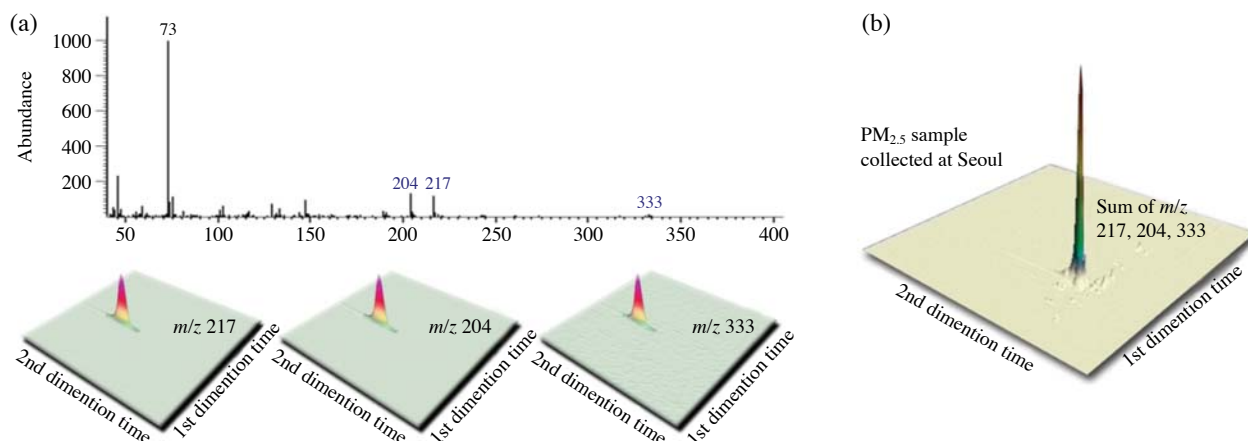

Fig. 8. (a) Mass spectrum of Levoglucosan-TMS-derivatives by GC \times GC-TOFMS and two dimensional chromatogram for m/z 217, 204, and 333. (b) Sum of m/z 217, 204, and 333 for the Levoglucosan analysis in $PM_{2.5}$ sample collected at Seoul.

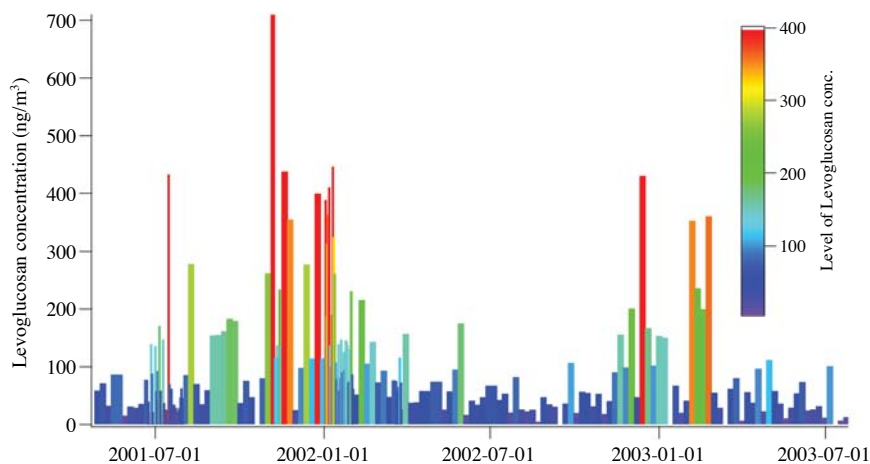

Fig. 9. Seasonal variations of Levoglucosan in the urban area.

defined as Levoglucosan-TMS-derivatives by GC \times GC-TOFMS analysis. Fig. 8(b) presents an example of peak identification (sum of m/z 217, 204, and 333) for Levoglucosan in $PM_{2.5}$ sample collected at Seoul, a mega city of the East Asia countries, using a high volume sampler. This analytical process confirmed that the analysis of Levoglucosan based on the found m/z can clearly identify the level of ambient concentrations using GC \times GC-TOFMS analytical technique.

3.5 Concentration of Levoglucosan: Understanding Seasonal Variation

Levoglucosan has been identified as a unique and strong molecular marker for wood combustion and biomass burning. It has been used in source profiles of this source in several CMB analyses including the St. Louis Supersite and is resolved as a unique factor

in the PMF analysis. Jeckel *et al.* (2007) shows the PMF characteristics are strong evidence that this is a wood combustion factor. OC contributions from the wood combustion factor are plotted against monitored Levoglucosan concentrations for the optimized case to show good correlation. The PMF wood combustion factor for the optimized case is also compared to the CMB wood combustion source.

Given the time series variation for the Levoglucosan at the St. Louis Supersite from April in 2001 through July in 2003 in Fig. 9 colored by the level of concentrations shows definitive seasonal patterns. Approximately 202 daily samples are available with one in third sampling schedule during the period to investigate trends within and across seasons which can be defined as Winter (December-February), Spring (March-May), Summer (June-August) and Fall (September-Novem-

Table 2. Summary of analytical characteristics.

	ECOC	GC/MS	AMS	GC × GC TOFMS
Detector	NDIR ⁽¹⁾	MS ⁽²⁾	TOFMS ⁽³⁾	TOFMS ⁽³⁾
Carrier Gas	He	He	Real time Ambient Air	He
Molecular ID Sensitivity for ambient sample	Low	High	Low	High
Solvent Extraction Required	No	DCM ⁽⁴⁾ and Methanol	No	DCM ⁽⁴⁾ and Methanol
Methylation	No	Diazomethane	No	No
Silylation	No	(TMS-derivatives) ⁽⁵⁾	No	TMS-derivatives ⁽⁵⁾
Mass Fragment ions (<i>m/z</i>)	N/A	60, 73 ⁽⁶⁾	60.02, 73.03	217, 204, 333 ⁽⁷⁾
Calibration	Sucrose and Internal Methane	Internal Standard & Standard Injection	CE and RIE ⁽⁸⁾	Internal Standard & Standard Injection

⁽¹⁾Nondispersive infrared sensor⁽²⁾Mass Spectrometry⁽³⁾Time of flight mass spectrometry⁽⁴⁾Dichloromethane⁽⁵⁾Trimethylsilyl derivatives⁽⁶⁾Extracted under Methylation, then Silylation⁽⁷⁾Extracted under Silylation only⁽⁸⁾Collection Efficiency and Relative Ionization Efficiencies

ber). The grand mean Levoglucosan is 103 ng m⁻³ with the maxima of 710 ng m⁻³. Summer exhibits the smallest concentrations of 56 ng m⁻³. The difference indicates 111 ng m⁻³ between summertime and wintertime, which is 3.0 times greater than the summertime. Mean concentration of 62 and 139 ng m⁻³ for Spring and Fall, respectively. The daily ratios have been normalized by the median ratio to clarify the seasonal behavior with respect to the overall data set. Fall and winter (cold season) seasonal medians are higher the grand median while spring and summer (warm season) seasonal medians are below the grand median.

Table 3 shows the summary of the level of Levoglucosan concentrations with the list of locations, times, and previous publications for each of these studies. The mass spectra for Levoglucosan analysis were mostly performed with the GC/MS method to allow the identification of more than two other organic components. The time series of mass concentrations and the mass spectra of the components were obtained and classified as Levoglucosan and some other small organic components. Area in Indonesia produce a very sharp contrast in time between haze and clean day, due to the more local specific sources. In addition, Brazil and the United States have noticeably higher biomass burning impact to their areas. In addition, biomass burning events account for a significant fraction of the total organic aerosol compared to organic carbon concentrations, also, listed in Table 3. Overall, biomass burning aerosols are estimated to make a major contribution to organic aerosol globally, although with a larger contribution further south from the mid-latitude region covered here. Their effect at a specific ground site tends to be highly episodic depending on

the proximity and intensity of major fires, and they can often be readily identified by tracers such as gas-phase acetonitrile and particle-phase Levoglucosan.

4. IMPLICATION: IMPACT TO HUMAN HEALTH

4.1 Analytical Method for Urinary Levoglucosan as a Biomarker of Wood Smoke Exposure

Levoglucosan in human urine was first reported in 1986 by Dorland *et al.* using one-dimensional thin-layer chromatography. Also, the other study, Migliaccio *et al.*, reported that Levoglucosan can be detected in mouse urine (using GC/MS) after multiple instillations and/or exposure that included pure Levoglucosan, concentrated wood smoke particulates, and wood smoke inhalation. It is recently reported that diet such as caramel disturbs determining urinary Levoglucosan levels, therefore recent dietary history needs to be taken into account for future work involving Levoglucosan as a biomarker of wood smoke exposure (Bergauff *et al.*, 2010).

4.2 Impact to Human Health

It is common now that, air pollution, especially by fine particulate matter exposure, is associated with the increased incidence of respiratory and cardiovascular diseases including respiratory infections, exacerbations of inflammatory lung conditions, cardiac events, stroke, eye disease, tuberculosis, cancer and hospital admissions with air pollution levels (Naeher *et al.*, 2006). In addition, it is previously reported that long

Table 3. The concentration of Levoglucosan in various regions and seasons in field measurements.

Location	Type of region	Season	Sampling method	Analytical method	Case and concentration (ng/m ³)	OC; EC Conc. (ug/m ³)	Reference
Korea	Urban	Spring	PM _{2.5} cyclone sampler	GC-MS	Local	(1)	Park <i>et al.</i> , 2006
					Local+AD	(2)	
Australia	Urban	Summer Winter	Hi-vol sampler	GC-MS (<i>m/z</i> : 35-350)	Local+AD+BB	8.60; 3.06	Jordan <i>et al.</i> , 2006
					Waste burning	29.50; 3.68	
Canada	Urban	Summer	Hi-vol sampler	GC-MS	Urban	3.49; N.R.	Leithhead <i>et al.</i> , 2006
	Rural			GC-FID	Rural	1.94; N.R.	
Hungary	Rural	Summer	Hi-vol sampler	GC-MS (<i>m/z</i> : 45-450)	Mixed	3.13; N.R.	Ion <i>et al.</i> , 2005
U.S.A.	Suburban	N.R.	Low-vol sampler	GC-MS (<i>m/z</i> : 204)	24 h sampling ⁽³⁾	4.2; 0.20	Simpson <i>et al.</i> , 2004
					Daytime ⁽³⁾	4.3; 0.20	
Indonesia	Urban	Dry-wet season transition	High volume filtration	GC-MS (<i>m/z</i> : 378, 363, 333, 217, 204)	Nighttime ⁽³⁾	4.4; 0.20	Radzi bin Abas <i>et al.</i> , 2004
Western North Pacific	Asian Pacific region	Spring	Hi-vol sampler	GC-FID	Pacific (>140°E)	N.R.	Mochida <i>et al.</i> , 2003
East China sea				GC-MS	Pacific (<140°E)		
					East China sea		
Sea of Japan					Sea of Japan		
Brazil	Rodonia Rainforest	Dry-wet season transition	Hi-vol virtual impactor	HNMR GC-MS (<i>m/z</i> : 50-500)	HNMR (pasture)	1874	Graham <i>et al.</i> , 2002
					GC-MS (pasture)	2460	
Belgium	Gent Urban	Summer	Open-faced 'Total' filter sampler	GC-FID	GC-MS (rainforest)	1180	Zdrahal <i>et al.</i> , 2002
					Urban-summer	19.4	
Brazil	Rodonia Tropical	Wet season Dry season	Hi-vol virtual impactor	GC-MS (<i>m/z</i> : 50-550)	Urban-winter	477	Pashynska <i>et al.</i> , 2002
					Tropical-wet	4.4	
Belgium	Ghent Urban	Summer Winter	Open-faced 'Total' filter sampler	GC-MS (<i>m/z</i> : 45-500, 217 for levoglucosan)	Tropical-dry	2006	5.9; 1.24 10.7; 1.13
					Summer	19.1	
					Winter	420	

Table 3. Continued.

Location	Type of region	Season	Sampling method	Analytical method	Case and Concentration (ng/m ³)	OC; EC Conc. (ug/m ³)	Reference
California	Pasture Urban	Winter	Hi-vol sampler	GC-MS	Pasture Urban-1 Urban-2	N.R.	Nolte <i>et al.</i> , 2001
U.S.A.	Urban Coastal area	Summer	N.R.	GC-MS	Border of city Coastal area Urban area Industrial city	32.7; 0.2 32.6; 0.4 29.9; 0.2 30.4; 0.5 32.3; 0.4 15.2; <0.1 15.7; 0.7 10.3; <0.1 14.1; 0.1	Fraser and Lakshmanan, 2000

Abbreviation: AD (Asian dust), BB (biomass burning), N.R. (not reported)

⁽¹⁾Local: A (4.03; 2.03), B (8.50; 4.30), C (8.79; 4.46), F (5.80; 3.83), G (4.64; 1.96)

⁽²⁾Local+AD: D (5.19; 2.19), E (4.61; 2.50)

⁽³⁾Median value

term exposure to PM_{2.5} has been associated with, at least in part, increased acute and chronic mortality rates (Laden *et al.*, 2006). The mechanism behind these associations remains unclear. Many studies have suggested that exposure to air pollution, including particulate matter, is associated with cardiovascular morbidity and mortality (Miller *et al.*, 2007). Not only traffic-related air pollution, emissions from biomass burning may also be linked with adverse cardiovascular effects (Swiston *et al.*, 2008; Barregard *et al.*, 2006; Tan *et al.*, 2000). Two suggested possibilities on the explanation of particulate matter associated cardiovascular diseases are 1) a systemic inflammatory response following pulmonary deposition of particles and 2) endothelial dysfunction resulting from the release of inflammatory mediators (Bai *et al.*, 2007; Brook *et al.*, 2004).

Levoglucosan can be formed from pyrolysis of cellulose. Since Levoglucosan is one of the most abundant particle-phase organic compounds in wood smoke (Table 3). Recently, several groups have begun to evaluate the suitability of urinary Levoglucosan as a biomarker for wood-smoke exposure (Migliaccio *et al.*, 2009; Hinwood *et al.*, 2008). In an inhalational exposure study Migliaccio found that mice exposed to wood smoke had higher levels of Levoglucosan in the urine, compared to control mice exposed to clean air.

Until now, although the mechanism of wood smoke remains unclear in human body and the effect of Levoglucosan is not clear enough, it is confirmed that Levoglucosan is the most abundant particle-phase organic compounds, we should consider that the health effect of Levoglucosan will provide important opportunities for clinical and epidemiological research for reducing incidence of cardiovascular and respiratory diseases.

ACKNOWLEDGEMENT

We acknowledge support for this research was supported by Basic Science Research Program through the National Research Foundation of Korea (NRF) funded by the Ministry of Education, Science and Technology (NRF-2011-0014998) and supported by Research Funds of Mokpo National University in 2011. In addition, this work was supported by the National Research Foundation of Korea Grant funded by the Korean Government [NRF-2009-353-D00039]. We thank Olga Hogrefe for her help of Aerosol Chamber and AMS operations.

REFERENCES

Abas, M.R., Oros, D.R., Simoneit, B.R.T. (2004) Biomass burning as the main source of organic aerosol

- particulate matter in Malaysia during haze episodes. *Chemosphere* 55, 1089-1095.
- Bae, M., Schauer, J.J., DeMinter, J.T., Turner, J.R., Smith, D., Cary, R.A. (2004) Validation of a semi-continuous instrument for elemental carbon and organic carbon using a thermal-optical method. *Atmospheric Environment* 38, 2885-2893.
- Bae, M., Schauer, J.J., Turner, J.R. (2006) Estimation of the monthly average ratios of organic mass to organic carbon for fine particulate matter at an urban site. *Aerosol Science and Technology* 40, 1123-1139.
- Bai, N., Khazaei, M., van Eeden, S.F., Laher, I. (2007) The pharmacology of particulate matter air pollution-induced cardiovascular dysfunction. *Pharmacology & Therapeutics* 113, 1629.
- Barregard, L., Sallsten, G., Gustafson, P., Andersson, L., Johansson, L., Basu, S., Stigendal, L. (2006) Experimental exposure to woodsmoke particles in healthy humans: Effects on markers of inflammation, coagulation, and lipid peroxidation. *Inhalation Toxicology* 18, 845-853.
- Bergauff, M.A., Ward, T.J., Noonan, C.W., Migliaccio, C.T., Simpson, C.D., Evanoski, A.R., Palmer, C.P. (2010) Urinary Levoglucosan as a biomarker of wood smoke: results of human exposure studies. *Journal of Exposure Science and Environmental Epidemiology* 20, 385-392.
- Brauer, M., Hisham-Hashim, J. (1998) Fires in Indonesia: crisis and reaction. *Environmental Science and Technology* 32, 404-407.
- Brook, R.D., Franklin, B., Cascio, W., Hong, Y.L., Howard, G., Lipsett, M., Luepker, R., Mittleman, M., Samet, J., Smith, S.C., Tager, I. (2004) Air pollution and cardiovascular disease a statement for healthcare professionals from the expert panel on population and prevention science of the American heart association. *Circulation* 109, 2655-2671.
- Crutzen, P.J., Delaney, A.C., Greenberg, J., Haagenson, P., Heidt, L., Lueb, R., Pollock, W., Seiler, W., Wartburg, A., Zimmerman, P. (1985) Tropospheric chemical composition measurements in Brazil during the dry season. *Journal of Atmospheric Chemistry* 2, 233-256.
- Dorland, L., Wadman, S.K., Fabery, J.H., Ketting, D. (1986) 1,6-Anhydro- β -D-glucopyranose (β -glucosan), a constituent of human urine. *Clinica Chimica Acta* 159, 11-16.
- Ezzati, M., Kammen, D.M. (2001) Quantifying the effects of exposure to indoor air pollution from biomass combustion on acute respiratory infections in developing countries. *Environmental Health Perspectives* 109, 481-488.
- Fraser, M., Lakshmanan, K. (2000) Using levoglucosan as a molecular marker for the long-range transport of biomass combustion aerosols. *Environmental Science and Technology* 34, 4560-4564.
- Graham, B., Mayol-Bracero, O., Guyon, P., Roberts, G., Decesari, S., Facchini, M., Artaxo, P., Maenhaut, W., Koll, P., Andreae, M. (2002) Water-soluble organic compounds in biomass burning aerosols over Amazonia-I. Characterization by NMR and GC-MS. *Journal of Geophysical Research* 107, 1-16.
- Hinwood, A., Trout, M., Meurby, J., Barton, C., Symons, R. (2008) Assessing urinary Levoglucosan and methoxyphenols as biomarkers for use in woodsmoke exposure studies. *Science of the Total Environment* 402, 139-146.
- Ion, A., Vermeylen, R., Kourtchev, I., Cafmeyer, J., Chi, X., Gelencser, A., Maenhaut, W., Claeys, M. (2005) Polar organic compounds in rural PM_{2.5} aerosols from K-puszt, Hungary, during a 2003 summer field campaign: Sources and diel variations. *Atmospheric Chemistry and Physics* 5, 1805-1814.
- Jaekels, J.M., Bae, M., Schauer, J.J. (2007) Positive Matrix Factorization (PMF) analysis of molecular marker measurements to quantify the sources of organic aerosols. *Environmental Science and Technology* 41, 5763-5769.
- Jayne, J.T., Leard, D.C., Zhang, X., Davidovits, P., Smith, K.A., Kolb, C.E., Worsnop, D.R. (2000) Development of an aerosol mass spectrometer for size and composition analysis of submicron particles. *Aerosol Science and Technology* 33, 49-70.
- Jordan, T.B., Seen, A.J., Jacobsen, G.E. (2006) Levoglucosan as an atmospheric tracer for woodsmoke. *Atmospheric Environment* 40, 5316-5321.
- Laden, F., Schwartz, J., Speizer, F.E., Dockery, D.W. (2006) Reduction in fine particulate air pollution and mortality: extended follow-up of the Harvard six cities study. *American Journal of Respiratory and Critical Care Medicine* 173, 667-672.
- Larson, T.V., Koenig, J.Q. (1994) Wood smoke emissions and non-cancer respiratory effects. *Annual Review of Public Health* 15, 133-156.
- Lee, J., Lane, D.A. (2009) Unique products from the reaction of naphthalene with the hydroxyl radical. *Atmospheric Environment* 43, 4886-4893.
- Lee, J., Lane, D.A. (2010) Formation of oxidized products from the reaction of gaseous phenanthrene with the OH radical in a reaction chamber. *Atmospheric Environment* 44, 2469-2477.
- Leithead, A., Li, S., Hoff, R., Cheng, Y., Brook, J. (2006) Levoglucosan and dehydroabietic acid: Evidence of biomass burning impact on aerosols in the Lower Fraser Valley. *Atmospheric Environment* 40, 2721-2734.
- Levine, J.S. (1991) Introduction. In: *Global Biomass Burning: Atmospheric, Climatic, and Biospheric Implications*. (Levine J.S. Ed.), MIT Press, Cambridge, pp. 25-30.
- Levine, J.S. (1996) Introduction. In: *Biomass Burning and Global Change*. (Levine, J.S. Ed), MIT Press, Cambridge, pp. 35-43.
- Lobert, J.M., Scharffe, D.H., Hao, W.M., Crutzen, P.J. (1990) Importance of biomass burning in the atmospheric budgets of nitrogen-containing gases. *Nature* 346, 552-554.
- Mader, B.T., Schauer, J.J., Seinfeld, J.H., Flagan, R.C.,

- Yu, J.Z., Yang, H., Lim, H.J., Turpin, B.J., Deminter, J.T., Heidemann, G., Bae, M., Quinn, P., Bates, T., Eatough, D.J., Huebert, B.J., Bertram, T., Howell, S. (2003) Sampling methods used for the collection of particle-phase organic and elemental carbon during ACE-Asia. *Atmospheric Environment* 37, 1435-1449.
- Migliaccio, C.T., Bergauff, M.A., Palmer, C.P., Jessop, F., Noonan, C.W., Ward, T.J. (2009) Urinary levoglucosan as a biomarker of wood smoke exposure: observations in a mouse model and in children. *Environmental Health Perspectives* 117, 74-79.
- Miller, K.A., Siscovick, D.S., Sheppard, L., Shepherd, K., Sullivan, J.H., Anderson, G.L., Kaufman, J.D. (2007) Longterm exposure to air pollution and incidence of cardiovascular events in women. *New England Journal Of Medicine* 356, 447-458.
- Mochida, M., Kawamura, K., Umemoto, N., Kobayashi, M., Matsunaga, S., Lim, H., Turpin, B., Bates, T., Simoneit, B. (2003) Spatial distributions of oxygenated organic compounds (dicarboxylic acids, fatty acids, and Levoglucosan) in marine aerosols over the western Pacific and off the coast of East Asia: Continental outflow of organic aerosols during the ACE-Asia campaign. *Journal of Geophysical Research* 108, D23.
- Naeher, L.P., Brauer, M., Lipsett, M., Zelikoff, J.T., Simpson, C.D., Koenig, J.Q., Smith, K.R. (2006) Wood-smoke health effects: A review. *Inhalation Toxicology* 19, 67-106.
- Nolte, C., Schauer, J., Cass, G., Simoneit, B. (2001) Highly polar organic compounds present in wood smoke and in the ambient atmosphere. *Environmental Science and Technology* 35, 1912-1919.
- Park, S., Bae, M., Schauer, J., Kim, Y., Cho, S., Kim, S. (2006) Molecular composition of PM_{2.5} organic aerosol measured at an urban site of Korea during the ACE-Asia campaign. *Atmospheric Environment* 40, 4182-4198.
- Pashynska, V., Vermeylen, R., Vas, G., Maenhaut, W., Claeys, M. (2002) Development of a gas chromatographic/ion trap mass spectrometric method for the determination of Levoglucosan and saccharidic compounds in atmospheric aerosols. Application to urban aerosols. *Journal of Mass Spectrometry* 37, 1249-1257.
- Schauer, J.J., Cass, G.R. (2000) Source apportionment of wintertime gas-phase and particle-phase air pollutants using organic compounds as tracers. *Environmental Science and Technology* 34, 1821-1832.
- Schauer, J.J., Rogge, W.F., Hildemann, L.M., Mazurek, M.A., Cass, G.R. (1996) Source apportionment of airborne particulate matter using organic compounds as tracers. *Atmospheric Environment* 30, 3837-3855.
- Shafidazeh, F. (1984) The chemistry of pyrolysis and combustion. *Advances in Chemistry Series* 207, 489-529.
- Simpson, C., Dills, R., Katz, B., Kalman, D. (2004) Determination of Levoglucosan in atmospheric fine particulate matter. *Journal of the Air & Waste Management Association* 54, 689-694.
- Smith, K.R. (2000) National burden of disease in India from indoor air pollution. *Proceedings of the National Academy of Sciences USA* 97, 13286-13293.
- Swiston, J.R., Davidson, W., Attridge, S., Li, G.T., Brauer, M., van Eeden, S.F. (2008) Wood smoke exposure induces a pulmonary and systemic inflammatory response in firefighters. *European Respiratory Journal* 32, 129-138.
- Tan, W.C., Qiu, D.W., Liam, B.L., Ng, T.P., Lee, S.H., van Eeden, S.F., D'Yachkova, Y., Hogg, J.C. (2000) The human bone marrow response to acute air pollution caused by forest fires. *American Journal of Respiratory and Critical Care Medicine* 161, 1213-1217.
- Zdrahal, Z., Oliveira, J., Vermeylen, R., Claeys, M., Maenhaut, W. (2002) Improved method for quantifying Levoglucosan and related monosaccharide anhydrides in atmospheric aerosols and application to samples from urban and tropical locations. *Environmental Science and Technology* 36, 747-753.

(Received 26 August 2011, revised 7 February 2012, accepted 7 February 2012)