

## Performance Improvement of the Nonlinear Fuzzy PID Controller

Jong Hwa Kim<sup>†</sup> · Jae Kwon Lim<sup>1</sup> · Ha Na Joo<sup>2</sup>

(Received October 30, 2012; Revised November 13, 2012; Accepted November 22, 2012)

**Abstract :** This paper suggests a new fuzzy PID controller with variable parameters which improves the shortage of the fuzzy PID controller with fixed parameters suggested in [9]. The derivation procedure follows the general design procedure of the fuzzy logic controller, while the resultant control law is the form of the conventional PID controller. Therefore, the suggested controller has two advantages. One is that it has only four fuzzy linguistic rules and analytical form of control laws so that the real-time control system can be implemented based on low-price microprocessors. The other is that the PID control action can always be achieved with time-varying PID controller gains only by adjusting the input and output scalers at each sampling time.

**Key words :** Fuzzy PID controller, variable design parameter, nonlinear system, unmodeled system

### 1. Introduction

PID controllers have been widely used for industrial systems with advantages such as their structural simplicity and easy hardware implementation [1]. Nevertheless, they provide high control performance and stability for the given system. On the other hand, the conventional PID controllers can not be applied to nonlinear systems and/or mathematically unmodeled systems [2]. Because they are model-based fixed structure controllers for controlling linear time invariant systems.

Fuzzy controllers in general are suitable for such nonlinear unmodeled systems based on fuzzy linguistic rules under the assumption that input/output information about the given system are sufficiently well known [3-4]. By the way, fuzzy controllers requires so many rules for satisfying design control performance and thus cannot avoid

consuming much computation time. This implies that fuzzy controllers can not be implemented by using low-priced digital microprocessors in view of real-time control.

Nowadays, in order to control nonlinear and/or unmodeled system, several types of fuzzy PID controllers has been developed, which combine the advantage of fuzzy controller with that of PID controller[5~8]. One of them is the nonlinear fuzzy PID controller suggested by Kim and Oh[9]. Its derivation procedure follows the general design procedure of fuzzy linguistic controller, while the resultant control law has the form of conventional PID controller. And also, the stability analysis for the fuzzy PID controller was addressed in [10] using small gain theorem.

By the way, a shortage of the fuzzy PID controller is that the PID control action is achieved only when the scaled inputs are within  $[-L, L]$  on

---

<sup>†</sup> Corresponding Author (Korea Maritime University, Division of IT Engineering,  
E-mail: kimjh@hhu.ac.kr, Tel: 051-410-4343)

<sup>1</sup> Korea Maritime University, Graduate School, E-mail: jackson76@dreamwiz.com, Tel: 051-410-4894

<sup>2</sup> LG Electronics Ltd., E-mail: wngksk0720@naver.com, Tel: 051-410-0567

the fuzzification input space. In order to overcome the shortage, the variable design parameter fuzzy PID was proposed by I. Kim [11].

The key point of the control method is that the normalization parameter  $L$  of the fuzzy inputs is varied according to the maximal magnitude among scaled inputs at each sampling time and thus the PID control action can always be achieved. However, this method has also the disadvantage that the control performance in steady-state is not good. That is, the PID control action can not be achieved accurately. Because  $L$  is so big that the controller can not perform the accurate control for the small inputs in steady-state.

In this paper, a new fuzzy PID control method is suggested. In this method, all scaled inputs are always within  $[-L, L]$  by changing scalers whenever the scaled inputs are beyond the normal operating input range  $[-L, L]$ . Conclusively, the PID controller can always achieve the PID control action regardless of the magnitudes of scaled inputs. The effectiveness of the suggested method is verified by means of comparing control responses between fuzzy PID controllers through several simulations.

## 2. The fixed parameter fuzzy PID controller

The structure of fuzzy PID controller suggested in [9] is given as **Figure 1**.

The notations used in **Figure 1** is as follows.

$$\begin{aligned}
 e(nT) &= ref(nT) - y(nT) \\
 e^* &= GE \times e(nT) \\
 r(nT) &= [e(nT) - e(nT - T)] / T \\
 r^* &= GR \times r(nT) \\
 a(nT) &= [r(nT) - r(nT - T)] / T \\
 a^* &= GA \times a(nT) \\
 dU(nT) &= dU_1(nT) + dU_2(nT) \\
 du(nT) &= GU \times dU(nT)
 \end{aligned}
 \tag{1}$$

$$u(nT) = du(nT) + u(nT - T)$$

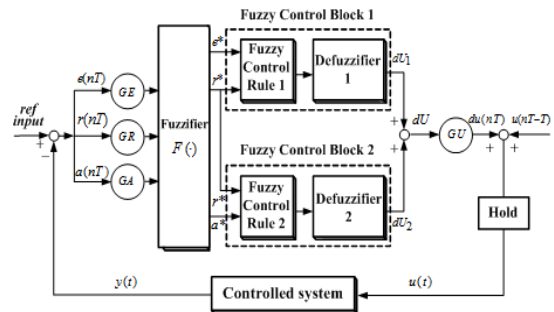

**Figure 1:** The structure of the fuzzy PID controller

$n$  is positive integer and  $T$  is sampling time.  $y(nT)$ ,  $e(nT)$ ,  $r(nT)$ , and  $a(nT)$  are output of the controlled system, error, rate of error (abbreviated as rate), and rate of rate(abbreviated as acc) respectively.  $GE$ ,  $GR$ , and  $GA$  are input scalers corresponding to fuzzy input error, rate, and acc.  $GU$  is output scaler for fuzzy output  $dU$ .

$dU_1$  and  $dU_2$  are output of fuzzy control block 1 and fuzzy control block 2, and  $u(nT)$  is control input generated by fuzzy PID controller at current time  $t = nT$ .

The fuzzification algorithms for the scaled input  $e^*$ ,  $r^*$ , and  $a^*$  are shown in **Figure 2** and the output fuzzification algorithms for fuzzy control block 1 and 2 are shown in **Figure 3**.

In **Figure 2**, scaled input  $e^*$  has two members, that is,  $EP$  (means Error\_Positive) and  $EN$  (Error\_negative). Scaled input  $r^*$  and  $a^*$  have also two similar members like  $e^*$ . As shown in **Figure 3**,  $output1$ , the output of fuzzy control block 1, has three members  $OP$ (Output\_Positive),  $OZ$ (Output\_Zero), and  $ON$ (Output\_Negative).  $output2$ , the output of fuzzy control block 2, has two members  $OPM$ (Output\_Positive\_Middle) and  $ONM$ (Output\_Negative\_Middle). Here,  $L$  is a fixed constant determined by a controller designer and is used to normalize inputs.

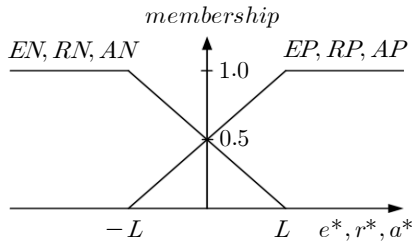

Figure 2: Input fuzzification algorithms

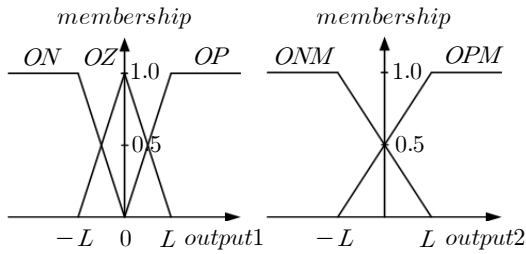

Figure 3: Output fuzzification algorithms

The fuzzy control rules for fuzzy control block 1 and 2 are as follows.

- $(R1)_1$  : IF  $e^* = EP$  and  $r^* = RP$ ,  $output1 = OP$
- $(R2)_1$  : IF  $e^* = EP$  and  $r^* = RN$ ,  $output1 = OZ$
- $(R3)_1$  : IF  $e^* = EN$  and  $r^* = RP$ ,  $output1 = OZ$
- $(R4)_1$  : IF  $e^* = EN$  and  $r^* = RN$ ,  $output1 = ON$
- $(R1)_2$  : IF  $r^* = RP$  and  $a^* = AP$ ,  $output2 = OPM$
- $(R2)_2$  : IF  $r^* = RP$  and  $a^* = AN$ ,  $output2 = ONM$
- $(R3)_2$  : IF  $r^* = RN$  and  $a^* = AP$ ,  $output2 = OPM$
- $(R4)_2$  : IF  $r^* = RN$  and  $a^* = AN$ ,  $output2 = ONM$

In control rules, Zadeh AND logic is applied to each rule and Lukasiewicz OR logic is applied to each control block for combining four rules.

The partitions of input space to evaluate fuzzy control rules are shown in Figure 4 and Figure 5 for fuzzy control block 1 and 2, respectively.

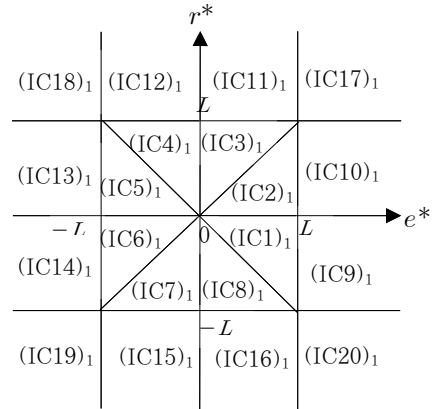

Figure 4: Partition of input space for fuzzy control block 1

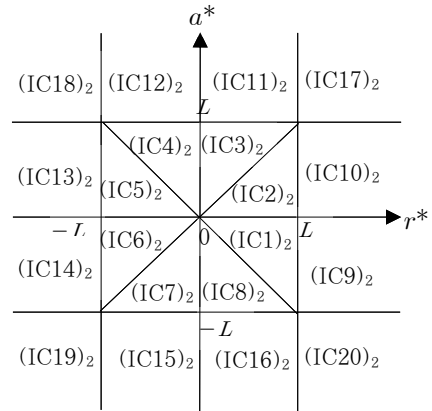

Figure 5: Partition of input space for fuzzy control block 2

By applying fuzzy control rules to partitions of input space and using the center of area method as a defuzzification algorithm, the resultant incremental control input corresponding to the following four cases can be obtained when input pair  $(e^*, r^*)$  and  $(r^*, a^*)$  lie within input space  $[-L, L]$  which means normal operating input interval.

$$\begin{aligned}
 &1) \text{ IF } |r^*(nT)| \leq |e^*(nT)| \leq L \\
 &\quad \text{and } |a^*(nT)| \leq |r^*(nT)| \leq L, \text{ Then} \\
 &du(nT) = \frac{0.5 \times L \times GU}{2L - |e^*(nT)|} [e^*(nT) + r^*(nT)] \quad (2) \\
 &\quad + \frac{0.25 \times L \times GU}{2L - |r^*(nT)|} [a^*(nT)]
 \end{aligned}$$

- 2) IF  $|r^*(nT)| \leq |e^*(nT)| \leq L$   
and  $|r^*(nT)| \leq |a^*(nT)| \leq L$ , Then

$$du(nT) = \frac{0.5 \times L \times GU}{2L - |e^*(nT)|} [e^*(nT) + r^*(nT)] \quad (3)$$

$$+ \frac{0.25 \times L \times GU}{2L - |a^*(nT)|} [a^*(nT)]$$

- 3) IF  $|e^*(nT)| \leq |r^*(nT)| \leq L$   
and  $|a^*(nT)| \leq |r^*(nT)| \leq L$ , Then

$$du(nT) = \frac{0.5 \times L \times GU}{2L - |r^*(nT)|} [e^*(nT) + r^*(nT)] \quad (4)$$

$$+ \frac{0.25 \times L \times GU}{2L - |r^*(nT)|} [a^*(nT)]$$

- 4) IF  $|e^*(nT)| \leq |r^*(nT)| \leq L$   
and  $|r^*(nT)| \leq |a^*(nT)| \leq L$ , Then

$$du(nT) = \frac{0.5 \times L \times GU}{2L - |r^*(nT)|} [e^*(nT) + r^*(nT)] \quad (5)$$

$$+ \frac{0.25 \times L \times GU}{2L - |a^*(nT)|} [a^*(nT)]$$

If Equations (2)-(4) are carefully investigated, it can be found that they have the exact conventional PID controller form. For example, if the followings are defined, Equation (1) is just the form of the velocity-type PID controller expressed as Equation (7) with variable control parameter  $K_p$ ,  $K_i$ , and  $K_d$ .

$$K_p = \frac{0.5 \times L \times GU \times GR}{2L - GE \times |e(nT)|}$$

$$K_i = \frac{0.5 \times L \times GU \times GE}{2L - GE \times |e(nT)|} \quad (6)$$

$$K_d = \frac{0.5 \times L \times GU \times GA}{2L - GR \times |r(nT)|}$$

$$du(nT) = K_i e(nT) + K_p r(nT) + K_d a(nT) \quad (7)$$

In Equation (6), input scaler  $GE$ ,  $GR$ ,  $GA$ , and output scaler  $GU$  are fixed design parameters and the normalization parameter  $L$  is also a fixed parameter. So the controller is called the fixed parameter fuzzy PID controller. If the response of the system is in steady state, the magnitude  $|e^*(nT)|$ ,  $|r^*(nT)|$ , and  $|a^*(nT)|$  are approached asymptotically to be zero. Then the linear PID controller can naturally be obtained as Equation (8),

$$du(nT) = K_i^* e(nT) + K_p^* r(nT) + K_d^* a(nT) \quad (8)$$

where  $K_p^*$ ,  $K_i^*$ , and  $K_d^*$  are constants.

By the way, when input pair  $(e^*, r^*)$  and  $(r^*, a^*)$  are beyond normal operating input space  $[-L, L]$ , for example (IC9)<sub>1</sub>~(IC20)<sub>1</sub> in fuzzy control block 1, the control input can no longer be expressed as the PID form. In this case, the resultant control input must be decided by **Table 3** and **Table 4** given in [9]. In these cases, there are so many condition rules that have to be executed by CPU based controller. This causes the real time control to be impossible and is a shortage of the fixed parameter fuzzy PID controller.

### 3. Suggestion of a new fuzzy PID controller

One method (not reviewed in this paper), called the variable design-parameter fuzzy PID controller, to improve the disadvantage of the fixed parameter fuzzy PID controller was suggested in [11] and [12]. In [11] and [12], the input scaler  $GE$ ,  $GR$ , and  $GA$  are fixed as the initial design values, while the normalization parameter  $L$  is varied as  $L(nT)$  whenever the combination of  $(e^*, r^*)$  and/or  $(r^*, a^*)$  are beyond input space  $[-L, L]$ . Therefore, the PID control action can always be achieved regardless of the magnitude of inputs. But, this method has also an another disadvantage that the steady state control behavior is not good. Since  $L(nT)$  is varied according to the maximum values of  $e^*$ ,  $r^*$ , or  $a^*$ , it converges to relatively small value in steady state. It causes the input spaces to make narrow and resultantly causes the PID control action to be overemphasized. Therefore, the PID gains are so sensitive for the input variations that the generated control input is fluctuated very frequently. This not only makes the steady state response worse but also makes the real implementation of the controller difficult.

In this paper, a new method, composed of two ideas, is suggested in the direction to improve the fixed parameter fuzzy PID controller and the variable design-parameter fuzzy PID controller. The first idea is to variate only scalers  $GE, GR, GA,$  and  $GU$  whenever scaled inputs  $e^*, r^*,$  and  $a^*$  are greater than the fixed normalization parameter  $L,$  that is, scaled input pairs are beyond the region  $[-L, L].$  This idea is to improve the disadvantage of the fixed parameter fuzzy PID and always makes input pairs remain within  $[-L, L]$  so that the controller can generate PID control action. The second idea is to maintain the initial design scaler values whenever the scaled inputs come again within  $[-L, L],$  which overcomes the disadvantage of the variable parameter fuzzy PID controller suggested in [11] and [12].

The conditions to implement the first idea are suggested as Equation (12).

$$\begin{aligned}
 &IF |e^*(nT)| > L \text{ THEN } GE(nT) = L/|e(nT)| \\
 &IF |r^*(nT)| > L \text{ THEN } GR(nT) = L/|r(nT)| \\
 &GU(nT) = 4/GR(nT)
 \end{aligned}
 \tag{12}$$

$$IF |a^*(nT)| > L \text{ THEN } GA(nT) = L/|a(nT)|$$

Then, input spaces for two fuzzy control blocks are partitioned as **Figure 6(a)** and **Figure 6(b),** and thus the fuzzy PID controller can always generate the PID control action regardless of the range of scaled inputs.

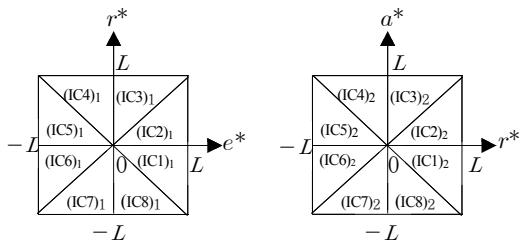

(a) For block 1

(b) For block 2

**Figure 6:** Partitions of fuzzification input spaces corresponding to the new fuzzy PID controller

The conditions to implement the second idea are suggested as Equation (13).

$$\begin{aligned}
 &IF |e^*(ref)| \geq |e^*(nT)| \\
 &THEN GE(nT) = L/|e(ref)| \\
 &IF |r^*(ref)| \geq |r^*(nT)| \\
 &THEN GR(nT) = L/|r(ref)| \\
 &GU(nT) = 4/GR(nT) \\
 &IF |a^*(ref)| \geq |a^*(nT)| \\
 &THEN GA(nT) = L/|a(ref)|
 \end{aligned}
 \tag{13}$$

It keeps in mind that Equation (12) and Equation (13) must be implemented simultaneously.

The resultant control laws are the same as Equations (2)-(6) except that  $GE(nT), GR(nT), GA(nT),$  and  $GU(nT)$  are varied according to the conditions given as Equation (12) and Equation (13) at each sampling time.

$$\begin{aligned}
 1) &IF |r^*(nT)| \leq |e^*(nT)| \leq L \\
 &\text{and } |a^*(nT)| \leq |r^*(nT)| \leq L, \text{ Then}
 \end{aligned}
 \tag{13}$$

$$\begin{aligned}
 du(nT) = &\frac{0.5 \times L \times GU(nT)}{2L - |e^*(nT)|} [e^*(nT) + r^*(nT)] \\
 &+ \frac{0.25 \times L \times GU(nT)}{2L - |r^*(nT)|} [a^*(nT)]
 \end{aligned}$$

$$\begin{aligned}
 2) &IF |r^*(nT)| \leq |e^*(nT)| \leq L \\
 &\text{and } |r^*(nT)| \leq |a^*(nT)| \leq L, \text{ Then}
 \end{aligned}
 \tag{14}$$

$$\begin{aligned}
 du(nT) = &\frac{0.5 \times L \times GU(nT)}{2L - |e^*(nT)|} [e^*(nT) + r^*(nT)] \\
 &+ \frac{0.25 \times L \times GU(nT)}{2L - |a^*(nT)|} [a^*(nT)]
 \end{aligned}$$

$$\begin{aligned}
 3) &IF |e^*(nT)| \leq |r^*(nT)| \leq L \\
 &\text{and } |a^*(nT)| \leq |r^*(nT)| \leq L, \text{ Then}
 \end{aligned}
 \tag{15}$$

$$\begin{aligned}
 du(nT) = &\frac{0.5 \times L \times GU(nT)}{2L - |r^*(nT)|} [e^*(nT) + r^*(nT)] \\
 &+ \frac{0.25 \times L \times GU(nT)}{2L - |r^*(nT)|} [a^*(nT)]
 \end{aligned}$$

$$\begin{aligned}
 4) &IF |e^*(nT)| \leq |r^*(nT)| \leq L \\
 &\text{and } |r^*(nT)| \leq |a^*(nT)| \leq L, \text{ Then}
 \end{aligned}
 \tag{16}$$

$$\begin{aligned}
 du(nT) = &\frac{0.5 \times L \times GU(nT)}{2L - |r^*(nT)|} [e^*(nT) + r^*(nT)] \\
 &+ \frac{0.25 \times L \times GU(nT)}{2L - |a^*(nT)|} [a^*(nT)]
 \end{aligned}$$

#### 4. Simulations for performance test

Let consider the following linear time-invariant under-damped feedback system. The system has the unit step response with 60% overshoot, 0.6 second rising time, and 10 seconds settling time.

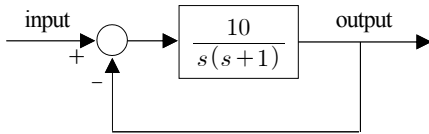

Figure 7: An under-damped feedback system

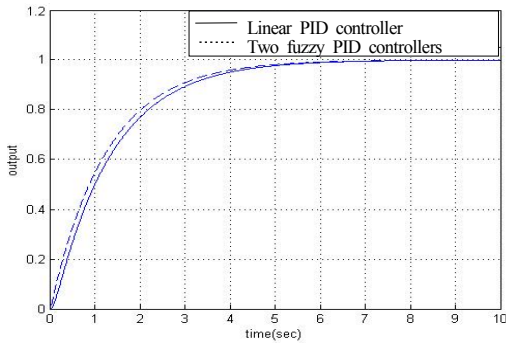

Figure 8: Unit step responses of control systems

In order to control the given nominal system the two types of fuzzy PID controllers are designed under the assumption that the unit step response is used to decide design parameters such as  $GE$ ,  $GR$ ,  $GA$ , and  $GU$ . Figure 8 shows the unit step responses of the linear PID controller and two fuzzy PID controllers. The responses of two fuzzy PID controllers are very identical and so good. The reason why the input spaces during operation are always within  $[-L, L]$  and consequently controller design parameters  $GE$ ,  $GR$ ,  $GA$ ,  $GU$ , and  $L$  were not changed.

By the way, in case that the reference input with step 3 greater than unit step used as the initial design input is applied to the system, the control responses are quite different each other as shown in Figure 9. Since the fixed fuzzy PID controller could not normally generate the PID control action

during 1.8 seconds initially, it presents a transient response as if it were saturated at maximum.

As a natural, the transient response is slower than that of the new suggested fuzzy PID controller as shown in Figure 9. While the response trend of the new suggested fuzzy PID controller is very similar to that of the unit step response.

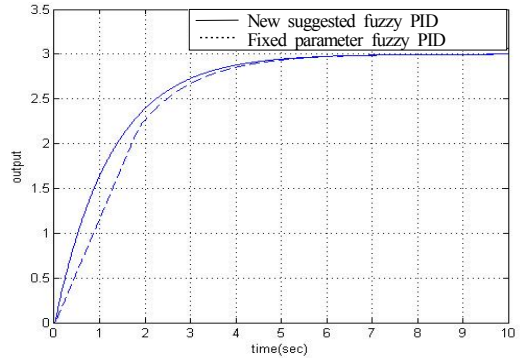

Figure 9: Responses of the fuzzy PID for reference input with step 3

This reason can be proved from Figure 10 and Figure 11.

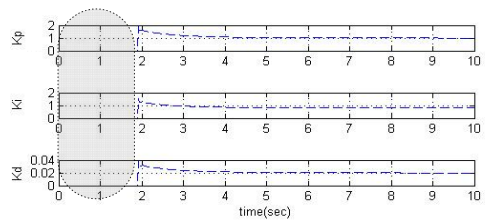

Figure 10: PID gains of the fixed parameter fuzzy PID for reference input with step 3

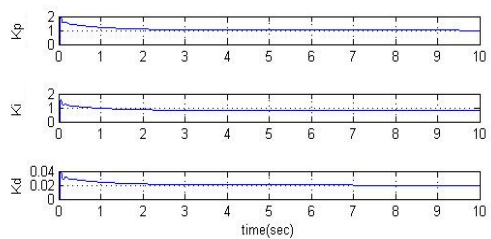
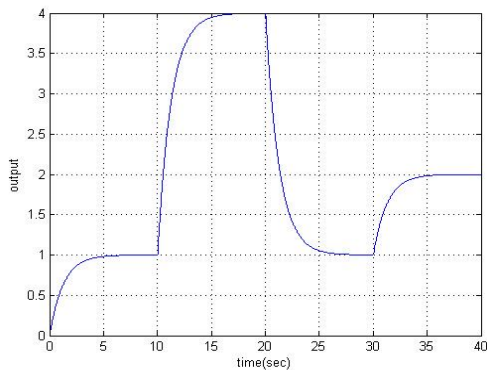

Figure 11: PID gains of the suggested fuzzy PID for reference input with step 3

The PID gains of the fixed parameter fuzzy PID controller did not computed during 1.8 seconds designated as ● in **Figure 10** because the input spaces of scaled inputs were beyond  $[-L, L]$ , as shown in **Figure 10**. While the PID gains of the suggested fuzzy PID controller was generated normally as shown in **Figure 11**.

Another simulation was executed in order to verify the control performance of the suggested fuzzy PID controller when the reference input is changed. At first stage, the reference input is applied as unit step during initial 10 seconds which is the same as the controller design input. And at second stage it is changed as step 3 beyond the designed normalization input range during 10 seconds to 20 second. At third stage, the reference input is returned to unit step during 10 second to 30 second. At last stage, it is changed from unit step to step 2 which is the same magnitude as the design reference input during last 10 seconds.

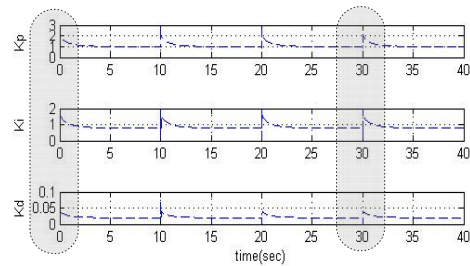

**Figure 12:** Response of the suggested fuzzy PID for reference input change

In spite of reference input change, the suggested fuzzy PID controller presents a very good control performance as shown in **Figure 12**. The reason of the result is explained by **Figure 13**.

As shown in **Figure 13**, the suggested fuzzy PID controller generates PID controller gains  $K_p$ ,  $K_i$ ,

and  $K_d$  normally based on the variable parameter  $GE(nT)$ ,  $GR(nT)$ ,  $GA(nT)$ , and  $GU(nT)$  according to reference input changes. It can also be found that the varied values of  $K_p$ ,  $K_i$ , and  $K_d$  are exactly the same whenever the reference input variations are identical, for instance corresponding to the time interval  $0 \leq t \leq 10$  and  $30 \leq t \leq 40$  second designated as ● in **Figure 13**, regardless of absolute magnitude of the reference input.



**Figure 13:** PID gains of the suggested fuzzy PID for reference input change

## 5. Conclusions

In this paper, the new fuzzy PID controller was suggested in order to improve the disadvantages of the fixed parameter fuzzy PID controller[9] and the variable parameter fuzzy PID controller[11-12]. Through simulation results, the effectiveness of the suggested fuzzy PID controller was verified. The design procedure of the suggested fuzzy PID is so simple compared with other types of fuzzy PID controllers used to control unmodeled systems, while the control performance is superior to others. It is the most important advantage of the suggested fuzzy PID controller.

## References

- [1] K. J. Åström and T. Hägglund, PID Controllers : Theory, Design and Tuning, Instrument Society of America, 1995.
- [2] K. J. Åström, K. H. Johansson and Q. G. Wang. "Design of decoupled PID controllers

- for MIMO systems,” Proceedings of the American Control Conference, vol. 3, pp. 2015-2020, 2001.
- [3] L. Wang, A Coures in Fuzzy Systems and Control, Prentice-Hall, 1997.
- [4] K. M. Passino and S. Yukovich, Fuzzy Control, Addison Wesley, 1999.
- [5] A. Heidar, M. H. Li and G. Chen, “New design and stability analysis of fuzzy proportional-derivative control system”, IEEE Transactions on Fuzzy Systems, vol. 2, pp 245~254, 1994.
- [6] S. K. Nam and W. S. Yoo, “Fuzzy PID control with accelerated reasoning for DC servo motors,” Engineering Application of Artificial Intelligent, vol. 7, pp. 559-569, 1994.
- [7] S. He, S. Tan, F. Xu and P. Wang, “Fuzzy self-tuning of PID controllers,” Fuzzy Sets and Systems, vol. 56, pp. 37-46, 1993.
- [8] H. A. Malki, D. Misir, D. Feigenspan and G. Chen, “Fuzzy PID control of a flexible-joint robot arm with uncertainties from time-varying loads,” IEEE Transactions on Control System Technology, vol. 5, pp. 371-378, 1997.
- [9] J. Kim and S. Oh, “A fuzzy PID controller for nonlinear and uncertain systems,” Soft Computing, vol. 4, pp. 123-129, 2000.
- [10] B. Lee, I. Kim, and J. Kim, “Stability analysis and proposal of the simplified form of a fuzzy PID controller with fixed parameters,” Journal of Korea Fuzzy Logic and Intelligent Systems Society, vol. 14, no. 7, pp. 807-815, 2004.
- [11] J. K. Kim, I. H. Kim and J. H. Kim, “A position control of nonlinear hydraulic system using variable design-parameter fuzzy PID controller,” Journal of Korean Society of Marine Engineering, vol. 28, no. 1, pp. 136-144, 2004 (in Korean).
- [12] I. H. Kim, “A study on the design method of a nonlinear fuzzy PID controller with variable parameters,” Ph.D Thesis, Korea Maritime University, Department of Control and Instrumentation Engineering, 2004 (in Korean).