

An Efficient Soft-Output MIMO Detection Method Based on a Multiple-Channel-Ordering Technique

Tae Ho Im, Insoo Park, Hyun Jong Yoo, Sungwook Yu, and Yong Soo Cho

In this paper, we propose an efficient soft-output signal detection method for spatially multiplexed multiple-input multiple-output (MIMO) systems. The proposed method is based on the ordered successive interference cancellation (OSIC) algorithm, but it significantly improves the performance of the original OSIC algorithm by solving the error propagation problem. The proposed method combines this enhanced OSIC algorithm with a multiple-channel-ordering technique in a very efficient way. As a result, the log likelihood ratio values can be computed by using a very small set of candidate symbol vectors. The proposed method has been synthesized with a 0.13- μm CMOS technology for a 4 \times 4 16-QAM MIMO system. The simulation and implementation results show that the proposed detector provides a very good solution in terms of performance and hardware complexity.

Keywords: MIMO, OSIC, K -best, QRD-M, QRM-MLD.

I. Introduction

Multiple-input multiple-output (MIMO) communication systems have received tremendous attention because of their high spectral efficiency and near-capacity performance. As a result, MIMO has become a key component in several wireless communication standards, including LTE-Advanced and IEEE 802.16m [1].

Multiple antennas can be used to improve the reception reliability by sending the same data (spatial diversity) or to increase data rates by sending different data (spatial multiplexing) [1], [2]. There are several detection methods for spatially multiplexed MIMO systems. The maximum likelihood (ML) algorithm leads to the best error performance, but it involves considerable computational complexity [1]. On the other hand, linear detection methods such as the zero-forcing algorithm or minimum mean-square-error algorithm are quite simple, but they show very poor performance. The ordered successive interference cancellation (OSIC) algorithm reduces the effect of interference signals by eliminating signals that are already detected [2]. Although the OSIC algorithm performs better than linear detection methods, it suffers from the error propagation problem [1], [2].

As a result, most recent works have focused on the detection methods that are based on tree searches, which achieve near-optimal performance but involve significantly less complexity than the original ML method [3]-[15]. Although some methods are based on the depth-first search algorithm [12]-[15], there has been great interest in signal detection methods that are based on the breadth-first search algorithm [5]-[10]. Such methods lead to fixed throughput very-large-scale integration (VLSI) systems. The K -best method and many of its variants belong to this category.

Manuscript received Oct. 1, 2010; revised Mar. 9, 2011; accepted Mar. 23, 2011.

This work was supported by the IT R&D program of MKE/KEIT [K1002084, A Study on Mobile Communication System for Next-Generation Vehicles with Internal Antenna Array] and the Human Resources Development of the Korea Institute of Energy Technology Evaluation and Planning (KETEP) grant funded by the Korea government Ministry of Knowledge Economy (No. 20104010100570).

Tae Ho Im (phone: +82 10 2971 4008, email: taeho.im@gmail.com), Insoo Park (email: thyle@naver.com), Hyun Jong Yoo (email: hyunjong.yoo84@gmail.com), Sungwook Yu (email: sungwook@cau.ac.kr), and Yong Soo Cho (corresponding author, email: yscho@cau.ac.kr) are with the School of Electrical and Electronic Engineering, Chung-Ang University, Seoul, Rep. of Korea.

<http://dx.doi.org/10.4218/etrij.11.0110.0574>

While most of recent detection methods are based on the tree search algorithm [3]-[15], this paper proposes an efficient detection method that is based on the OSIC algorithm. The performance of the original OSIC method itself is usually unacceptable for actual use, and there have been several attempts to enhance the original OSIC algorithm [16], [17]. These methods, however, cannot provide the best solution for soft-decoding MIMO systems because of the empty set problem [12], [13]. The proposed method enhances the OSIC algorithm and combines the algorithm with a multiple-channel-ordering technique in a very efficient way. As a result, the proposed method shows excellent performance, especially for soft-decoding MIMO systems.

The rest of this paper is organized as follows. In section II, the proposed method is explained and compared with the K -best method. Sections III and IV compare the proposed method with the K -best method in terms of performance and hardware complexity. Finally, the conclusions are given in section V.

II. Algorithm

In a MIMO system with N_T transmit antennas and N_R receiver antennas, the transmitted signal and the received signal are related as

$$\begin{aligned} \mathbf{r} &= \mathbf{H}\mathbf{x} + \mathbf{z}, \\ \mathbf{r} &= [r_1 \ r_2 \ \cdots \ r_{N_R}]^T, \\ \mathbf{x} &= [x_1 \ x_2 \ \cdots \ x_{N_T}]^T, \\ \mathbf{z} &= [z_1 \ z_2 \ \cdots \ z_{N_R}]^T, \end{aligned} \quad (1)$$

where \mathbf{r} is the received symbol vector, \mathbf{x} is the transmitted symbol vector, and \mathbf{z} is an independent and identically distributed (i.i.d.) complex zero-mean Gaussian noise. The element h_{ij} of the $N_R \times N_T$ matrix \mathbf{H} represents the complex transfer function from the j -th transmit antenna to the i -th receive antenna, and all h_{ij} 's are i.i.d. complex zero-mean Gaussian with a variance of 0.5 per dimension. For spatial multiplexing, the entries of \mathbf{x} are chosen independently from a set Ω of complex-valued constellation points with B bits per symbol (that is, $B = \log_2 |\Omega|$). In this paper, we assume that perfect synchronization and perfect channel estimation are achieved at the receiver side. Thus, it is assumed that temporal signal interference does not exist.

The column ordering of the matrix \mathbf{H} is important, and there have been several methods to obtain the optimal (column) ordering [3], [4].

By applying the QR-decomposition (QRD) on the matrix \mathbf{H} , we obtain $\mathbf{H} = \mathbf{Q}\mathbf{R}$, where \mathbf{Q} is an $N_R \times N_T$ unitary matrix and \mathbf{R} is an $N_T \times N_T$ upper triangular matrix. Then, multiplying both

```

1.  for  $i = 1 : N_T$ 
2.       $\mathbf{H}_i = [\mathbf{h}_{i1} \ \mathbf{h}_{i2} \ \mathbf{h}_{i3} \ \mathbf{h}_{i4}]$ 
3.       $[\mathbf{Q}_i \ \mathbf{R}_i] = \text{QRD}(\mathbf{H}_i)$ 
4.       $\mathbf{y}_i = (\mathbf{Q}_i)^H \mathbf{r}$ 
5.      for  $j = 1 : |\Omega|$ 
6.           $\hat{x}_{ij-4} = \Omega^{(j)}$ 
7.           $\hat{x}_{ij-3} = \mathcal{Q}((y_{i-3} - r_{i-34}\hat{x}_{ij-4}) / r_{33})$ 
8.           $\hat{x}_{ij-2} = \mathcal{Q}((y_{i-2} - r_{i-23}\hat{x}_{ij-3} - r_{i-24}\hat{x}_{ij-4}) / r_{22})$ 
9.           $\hat{x}_{ij-1} = \mathcal{Q}\begin{pmatrix} (y_{i-1} - r_{i-12}\hat{x}_{ij-2} \\ -r_{i-13}\hat{x}_{ij-3} - r_{i-14}\hat{x}_{ij-4}) / r_{11} \end{pmatrix}$ 
10.          $\hat{\mathbf{x}}_{ij} = [\hat{x}_{ij-1}, \hat{x}_{ij-2}, \hat{x}_{ij-3}, \hat{x}_{ij-4}]$ 
11.          $SED_{ij} = \|\mathbf{y}_i - \mathbf{R}_i \hat{\mathbf{x}}_{ij}\|^2$ 
12.          $LLR\_update(\hat{\mathbf{x}}_{ij}, SED_{ij})$ 
13.     end
14. end

```

Fig. 1. Pseudo-code for proposed method.

sides by \mathbf{Q}^H results in

$$\mathbf{Q}^H \mathbf{r} \triangleq \mathbf{y} = \mathbf{R}\mathbf{x} + \mathbf{Q}^H \mathbf{z}, \quad (2)$$

where $\mathbf{Q}^H \mathbf{z}$ has the same statistical characteristics as the original noise vector \mathbf{z} . Since the upper triangular matrix \mathbf{R} is more tractable than the original channel matrix \mathbf{H} , many MIMO detection methods use (2) instead of (1) [6], [7].

Figure 1 shows the pseudo-code of the proposed method, where $N_T = N_R = 4$ is assumed for convenience. Instead of deciding the optimal ordering and using a single channel matrix \mathbf{H} , the proposed method uses multiple channel matrices, without deciding the optimal channel ordering. This can be seen from the first two lines of the code, where \mathbf{H}_i represents a column-reordered version of \mathbf{H} . In other words, each column vector \mathbf{h}_{ik} in \mathbf{H}_i is chosen from the column vectors $\{\mathbf{h}_1, \mathbf{h}_2, \mathbf{h}_3, \mathbf{h}_4\}$ in \mathbf{H} . Since there are N_T columns in \mathbf{H} , there are as many as $N_T \times (N_T - 1) \times \cdots \times 1$ different ways of making \mathbf{H}_i . Among them, the proposed method uses only N_T channel matrices whose last columns are different from one another. There is no requirement for the orders of the other columns. The reason for using these multiple matrices will be explained later in this section.

Each \mathbf{H}_i is QR-decomposed, and \mathbf{y}_i is obtained as can be seen from lines 3 and 4 in Fig. 1. Then, as can be seen from (2), \mathbf{x}_i has to be computed (that is, estimated) for each \mathbf{y}_i and \mathbf{R}_i . Instead of computing a single \mathbf{x}_i , the proposed method obtains several candidates and chooses the best one. This can be seen from the inner *for*-loop in Fig. 1, where $\Omega^{(j)}$ represents the j -th symbol from Ω and $\mathcal{Q}(x)$ represents a slicing function, which selects the nearest symbol near x .

The inner *for*-loop is similar to the OSIC algorithm [2], but it is a new enhanced version that will be termed the enhanced OSIC (ESIC) algorithm. Unlike the original OSIC algorithm that obtains a single $x_{i,4}$ by computing $Q(y_{i,4}/r_{44})$ [2], the ESIC algorithm tries every $\Omega^{(j)}$ for $x_{ij,4}$. In other words, the ESIC method has multiple (that is, $|\Omega|$) candidates for $x_{i,4}$. A candidate symbol vector is obtained for each $x_{ij,4}$, as can be seen from lines 7 to 10, and the squared Euclidean distance (SED) is computed for each candidate vector as can be seen from line 11 in Fig. 1. For a hard decoding system, the candidate vector with the smallest SED becomes the estimated solution to the given detection problem.

As can be expected, the ESIC algorithm requires more computation and hardware. It, however, serves as an efficient solution to the error propagation problem since the candidate vector which is severely affected by the error propagation problem is not likely to have the minimum SED. The performance improvement far outweighs the hardware overhead, as can be seen in sections III and IV. More importantly, this ESIC algorithm can be efficiently combined with a multiple-channel-ordering technique for soft-output MIMO systems, as will be explained shortly in this section.

For a soft decoding system, the likelihood ratio (LLR) computation (or estimation) is required for each bit of the decoded symbol vectors in addition to the SED computation [13], [15]. Since there are N_T symbols where each symbol has B bits (that is, $B=\log_2|\Omega|$), there are $N_T \times B$ bits in a decoded symbol vector. The LLR for a bit b_{ij} is defined as follows [12], [13]:

$$L(b_{ij} | \mathbf{y}) = \ln \left(\frac{\Pr(b_{ij} = +1 | \mathbf{y})}{\Pr(b_{ij} = -1 | \mathbf{y})} \right), \quad (3)$$

where b_{ij} represents the j -th bit in the i -th symbol. Since the direct computation of (3) is very difficult, the following max-log approximation is usually adopted [12], [13]:

$$L(b_{ij} | \mathbf{y}) \approx \min_{\mathbf{x} \in \mathbf{X}_{ij}^{(-1)}} \|\mathbf{y} - \mathbf{R}\mathbf{x}\|^2 - \min_{\mathbf{x} \in \mathbf{X}_{ij}^{(1)}} \|\mathbf{y} - \mathbf{R}\mathbf{x}\|^2, \quad (4)$$

where the sets $\mathbf{X}_{ij}^{(-1)}$ and $\mathbf{X}_{ij}^{(1)}$ include all the symbol vectors whose j -th bit in the i -th symbol are -1 and $+1$, respectively. This approximation greatly reduces complexity at a cost of slight performance degradation [13].

Since $\mathbf{X}_{ij}^{(-1)}$ and $\mathbf{X}_{ij}^{(1)}$ satisfy $\mathbf{X}_{ij}^{(-1)} \cap \mathbf{X}_{ij}^{(1)} = \emptyset$ and $\mathbf{X}_{ij}^{(-1)} \cup \mathbf{X}_{ij}^{(1)} = \Omega^{N_T}$, (4) requires $|\Omega|^{N_T}$ ML metric computations. To reduce this enormous complexity, most tree search-based detection methods use some subset \mathbf{S} of Ω^{N_T} and use the following approximation:

$$L(b_{ij} | \mathbf{y}) \approx \min_{\mathbf{x} \in \mathbf{S}_{ij}^{(-1)}} \|\mathbf{y} - \mathbf{R}\mathbf{x}\|^2 - \min_{\mathbf{x} \in \mathbf{S}_{ij}^{(1)}} \|\mathbf{y} - \mathbf{R}\mathbf{x}\|^2, \quad (5)$$

where the sets $\mathbf{S}_{ij}^{(-1)}$ and $\mathbf{S}_{ij}^{(1)}$ satisfy $\mathbf{S}_{ij}^{(-1)} \cap \mathbf{S}_{ij}^{(1)} = \emptyset$ and

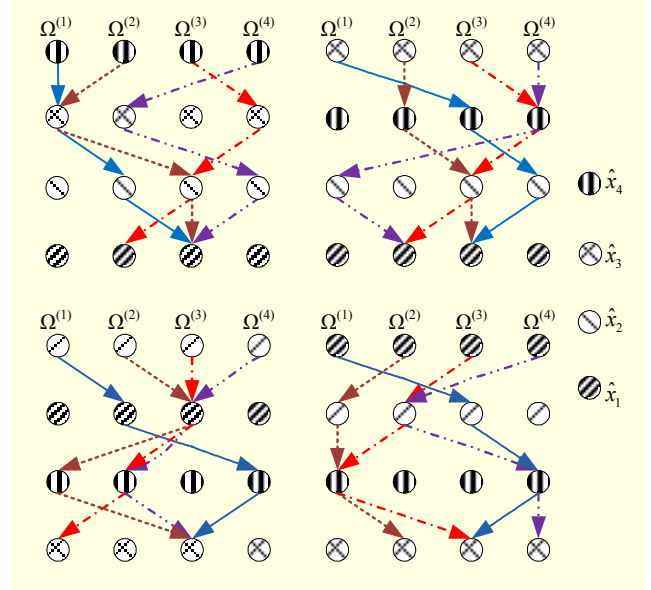

Fig. 2. Proposed method for 4×4 QPSK system.

$\mathbf{S}_{ij}^{(-1)} \cup \mathbf{S}_{ij}^{(1)} = \mathbf{S}$. For example, the K -best method usually uses the survivor candidates in the last stage as the subset \mathbf{S} . Although this reduces the complexity very much, it has a problem in that $\mathbf{S}_{ij}^{(-1)}$ or $\mathbf{S}_{ij}^{(1)}$ may be empty for some i and j . For example, it is possible that b_{11} in every symbol vector in \mathbf{S} happens to be -1 , which makes it impossible to compute the second term in (5). Although there have been several attempts to overcome this kind of problem, these solutions use extra hardware to estimate the LLR values or use some constant values, which causes performance degradation [12], [13].

On the other hand, the proposed method makes use of the multiple channel matrices to solve this problem. The outer *for*-loop in Fig. 1 describes the proposed multiple-channel-ordering technique. From now on, the ESIC algorithm with this multiple-channel-ordering technique will be called the MESIC method.

Figure 2 is an example that shows how the candidate vectors are generated in the MESIC method for a 4×4 quadrature phase shift keying (QPSK) system. A QPSK system has 4 constellation points (that is, $|\Omega|=4$), which can be represented by 2 bits (that is, $B=\log_2|\Omega|$). For example, the 4 constellation points can be represented by

$$\{\Omega^{(1)}, \Omega^{(2)}, \Omega^{(3)}, \Omega^{(4)}\} = \{(-1, -1), (-1, 1), (1, -1), (1, 1)\}. \quad (6)$$

As can be seen in the figure, there are 4 ($=N_T$) groups, where each group has 4 ($=|\Omega|$) candidate vectors. Thus, there are 16 (that is, $N_T \times |\Omega|$) candidate vectors. For each candidate vector, the SED is calculated, and then used for the LLR update in (5). The LLR update function in Fig. 1 (line 12) checks if the new SED_{ij} value is smaller than the existing one for each i

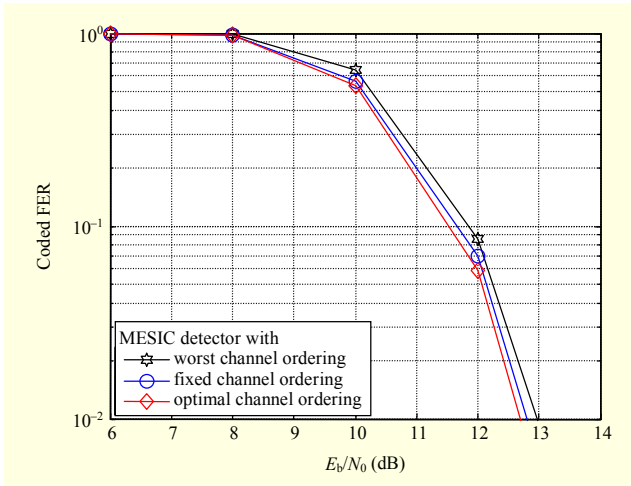

Fig. 3. FER comparison for hard decoding 4×4 16-QAM MIMO system (Viterbi decoding, rate: 0.5).

and j and keeps the smallest SED_{ij} value for each i and j . Since the candidate vectors in each group are generated by using the ESIC method, the last elements (which correspond to the first row) of the candidate vectors in each group include all the elements from Ω . Also, since the last columns of \mathbf{H}_i are all different, every x_k ($1 \leq k \leq N_T$) appears once (and only once) in the first rows of the four groups. Thus, $\mathbf{S}_{ij}^{(-)}$ and $\mathbf{S}_{ij}^{(+)}$ are non-empty for all i and j . In other words, by combining the ESIC algorithm and multiple orderings in an efficient way, the MESIC method can generate the LLR values for all the bits without using any LLR estimation methods.

It is possible to solve the empty set problem by adding some candidate vectors such as $\{1, 1, \dots, 1\}$ and $\{-1, -1, \dots, -1\}$. However, this does not guarantee a good decoding performance since it is very likely that the SED value by an arbitrary vector is very high. On the other hand, the candidate vectors in the proposed method are obtained by the ESIC method as can be seen from Fig. 1. Thus, it is very likely that the SED values by these candidate vectors are much smaller than the SED value by an arbitrary candidate vector.

It is very important to note that, in the proposed MESIC method, the orders of the multiple channel matrices can be fixed without knowing the channel condition. On the other hand, the OSIC and the K -best methods require the channel information to obtain the optimal ordering for the single channel matrix, which requires additional computation or hardware [3]. A more detailed comparison in terms of hardware requirements can be found in section IV.

Figure 3 shows the simulation results of the MESIC algorithm for a hard decoding 4×4 16-QAM MIMO system. The three graphs in the figure are based on the optimal channel ordering, the fixed channel ordering, and the worst channel ordering, respectively. The following channel matrices are used

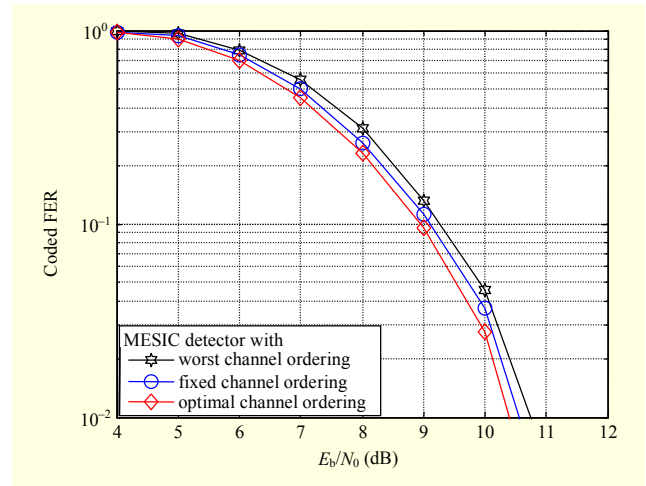

Fig. 4. FER comparison for soft decoding 4×4 16-QAM MIMO system (turbo coding, iteration: 3, rate: 0.5).

for the fixed channel ordering method.

$$\begin{aligned}
 \mathbf{H}_1 &= [\mathbf{h}_3, \mathbf{h}_4, \mathbf{h}_2, \mathbf{h}_1], \\
 \mathbf{H}_2 &= [\mathbf{h}_3, \mathbf{h}_4, \mathbf{h}_1, \mathbf{h}_2], \\
 \mathbf{H}_3 &= [\mathbf{h}_1, \mathbf{h}_2, \mathbf{h}_4, \mathbf{h}_3], \\
 \mathbf{H}_4 &= [\mathbf{h}_1, \mathbf{h}_2, \mathbf{h}_3, \mathbf{h}_4],
 \end{aligned} \tag{7}$$

Although the three graphs are not identical, it can be seen that the frame error rate (FER) difference is very small. This is mainly because there is no empty set problem in the optimal ordering case or the fixed/worst ordering cases. The situation is similar for a soft decoding system as can be seen in Fig. 4. In summary, the FER performance can be improved slightly by finding the best (optimal) column ordering, but the FER difference is too small to warrant the extra complexity required for finding the best ordering.

III. Performance Comparison

Table 1 summarizes the simulation parameters that are used in the performance comparison in this section. Figure 5 compares several detection methods in terms of the FER performance for the MIMO system in Table 1 when hard decoding is used. First of all, it can be seen that the performance of the original OSIC method is too poor to be used in practice. On the other hand, the ESIC method shows much better performance than the OSIC method.

This is because the OSIC method determines the first symbol without considering the remaining symbols, whereas the ESIC method makes a decision after considering all $|\Omega|$ candidate vectors. Thus, as explained in section II, the ESIC method is less likely to be affected by the error propagation problem. In fact, it can be seen that the ESIC method shows slightly better performance than the K -best method with $K=12$.

Table 1. Simulation parameters.

Parameter	Value
Channel	i.i.d. Rayleigh fading (8 tap)
Number of antennas	4×4
Data modulation	16 QAM
FFT size	64
Frame length	10 OFDM symbols
Channel coding (Hard decoding)	Convolutional coding (rate: 1/2) Viterbi decoding
Channel coding (Soft decoding)	Convolutional coding (rate: 1/2) Viterbi decoding Turbo coding (rate: 1/2) Turbo decoding (iteration: 3)

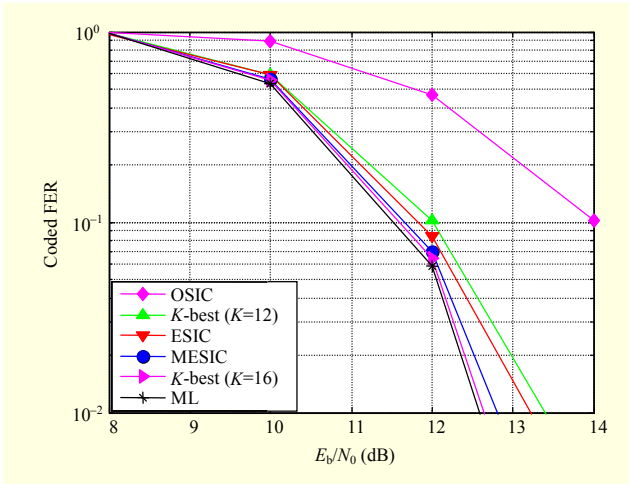

Fig. 5. FER comparison for hard decoding 4×4 MIMO system (Viterbi decoding, rate: 0.5).

Although the MESIC method shows better performance than the ESIC method, the difference (in the hard decoding case) is too small to justify the computational overhead incurred by the MESIC method.

Figures 6 and 7 show the FER comparison for the MIMO system in Table 1 when soft decoding is used. As in the hard decoding case, the OSIC method shows very poor performance, while the ESIC method shows much better performance. Unlike the hard decoding case, however, the MESIC method shows much better performance than the ESIC method and the K -best method.

As explained in the previous section, this is mainly because the LLR values for all the bits are obtained efficiently in the proposed MESIC method. Although the ML search (max-log) method shows the best performance, it uses (4) instead of (5), and as a result, it requires enormous computational complexity.

It should be emphasized that the MESIC method does not

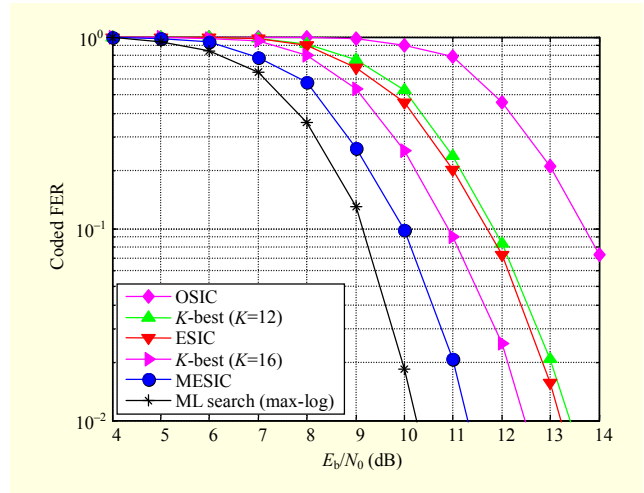

Fig. 6. FER comparison for soft decoding 4×4 MIMO system (Viterbi decoding, rate: 0.5).

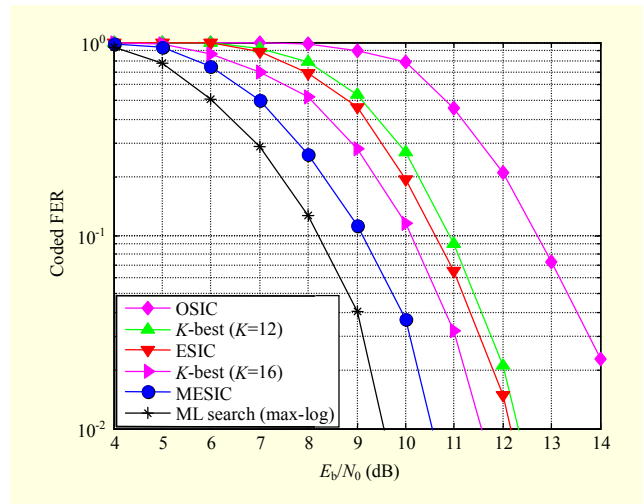

Fig. 7. FER comparison for soft decoding 4×4 MIMO system (turbo coding, iteration: 3, rate: 0.5).

require more candidate vectors than the K -best method in order to achieve the performance improvement. On the contrary, the MESIC method generally requires a smaller number of candidate vectors. As can be seen from section II, the number of candidate vectors in the K -best method is $K \times |\Omega|$, whereas the number of candidate vectors in the proposed method is $N_T \times |\Omega|$. In most cases, the value for K is the same as (or just a little bit smaller than) $|\Omega|$, whereas N_T is usually much smaller than $|\Omega|$. Table 2 shows the number of candidate vectors required for both the proposed and the K -best methods in several scenarios, which shows that the proposed method generally requires a much smaller number of candidate vectors.

Figures 8 and 9 show the simulation results for 4×4 16-QAM and 64-QAM MIMO systems. Both figures are based on the same parameters in Table 1 except the constellation sizes.

Table 2. Number of candidate vectors.

	K -best	MESIC
4×4 MIMO, QPSK ($K=4$)	16	16 (100%)
4×4 MIMO, 16-QAM ($K=12$)	192	64 (33.3%)
4×4 MIMO, 16-QAM ($K=16$)	256	64 (25%)
4×4 MIMO, 64-QAM ($K=32$)	2,048	256 (12.5%)
4×4 MIMO, 64-QAM ($K=64$)	3,072	256 (6.3%)
General case	$K \times \Omega $	$N_T \times \Omega $

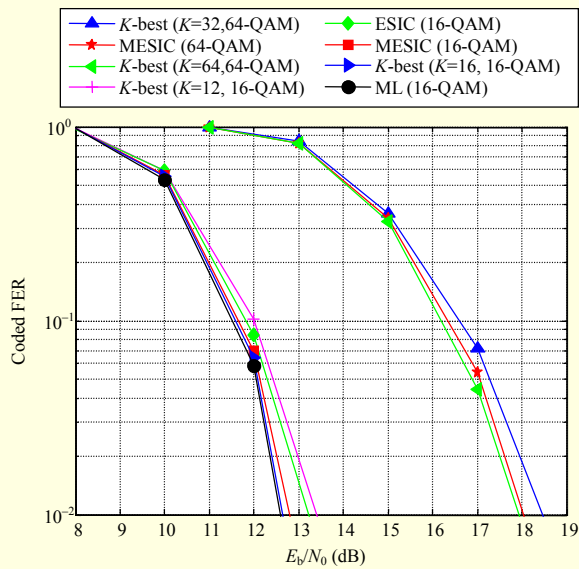

Fig. 8. FER comparison for hard decoding 4×4 16-QAM and 64-QAM MIMO systems (Viterbi decoding, rate: 0.5).

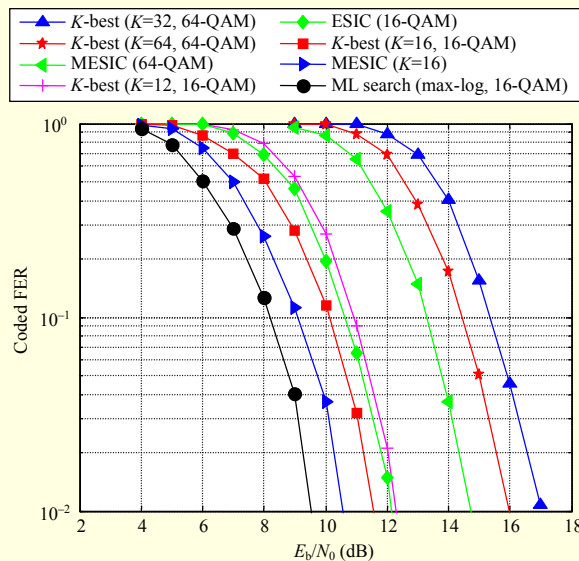

Fig. 9. FER comparison for soft decoding 4×4 16-QAM and 64-QAM MIMO systems (turbo coding, iteration: 3, rate: 0.5).

As can be seen in the figures, the MESIC method shows good performance (especially in the soft-decoding MIMO systems) regardless of the constellation sizes. Although the K -best method shows slightly better performance in the hard decoding case, it requires a much larger number of candidate vectors than the MESIC method (especially in the 64-QAM system) as can be seen from Table 2.

IV. Complexity Comparison

Figure 10 shows the block diagram of the proposed MESIC method for a 4×4 MIMO system. Among several methods for the implementation of the QRD algorithm, the proposed implementation is based on the modified Gram-Schmidt orthogonalization method, which is known to be very stable for a well-conditioned non-singular matrix [18]. Since the QRD requires a large number of multiplications and divisions, we used the log domain conversion technique [18].

The multiple-QRD unit is basically composed of 4 QRD units. Figure 11 shows the VLSI architecture of the basic QRD block. Since the QRD requires a large number of multiplications and divisions, the architecture in Fig. 11 uses the log domain conversion technique. We could have used 4 (basic) QRD blocks instead of using 1 multiple-QRD unit. In the implementation process, however, we found out that some of the blocks can be efficiently shared as follows. The multiple-QRD unit in Fig. 10 performs the QRD for 4 matrices in line 2 of Fig. 1. In other words, it performs the QRD on \mathbf{H}_1 , \mathbf{H}_2 , \mathbf{H}_3 , and \mathbf{H}_4 . As mentioned, the proposed method requires the last columns of \mathbf{H}_1 , \mathbf{H}_2 , \mathbf{H}_3 , and \mathbf{H}_4 be different, but there is no requirement for the orders of the other columns. Since the first two columns of \mathbf{H}_1 and \mathbf{H}_2 in (7) are the same and the first two columns of \mathbf{H}_3 and \mathbf{H}_4 are the same, the C_1 and C_2 blocks in Fig. 11 could be shared between \mathbf{H}_1 and \mathbf{H}_2 and between \mathbf{H}_3 and \mathbf{H}_4 . As a result, the multiple-QRD block in Fig. 10 uses 2 C_1 blocks, 2 C_2 blocks, 4 C_3 blocks, and 4 C_4 blocks instead of 4 C_1 blocks, 4 C_2 blocks, 4 C_3 blocks, and 4 C_4 blocks. It should be mentioned that this sharing does not affect the throughput.

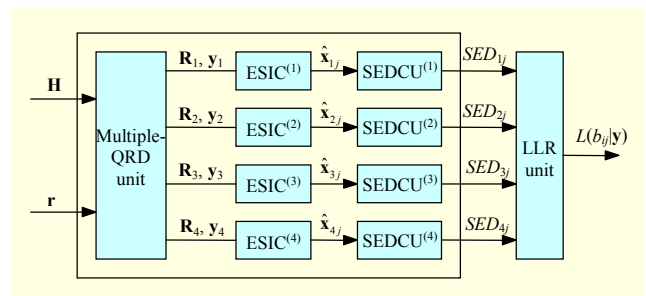

Fig. 10. High-level pipelined architecture for MESIC method.

Table 3. Implementation results for 4×4 MIMO detectors.

	Shen [10]	Guo [5]	Mondal [9]	Wenk [6]	<i>K</i> -best	MESIC	ESIC	OSIC
$ \Omega $	64-QAM	16-QAM	64-QAM	16-QAM	16-QAM	16-QAM	16-QAM	16-QAM
<i>K</i>	8	10	64	5	16	N/A	N/A	N/A
Throughput (Mbps)	252.6	106.6	100	376	2,400			
Area (KGE)	210	97	1,760	115	1,762	1,487	386	229
FOM	9.62	11.0	3.64	16.3	21.8	N/A	N/A	N/A
Technology	65 nm	0.35 μm	65 nm	0.25 μm	0.13 μm			

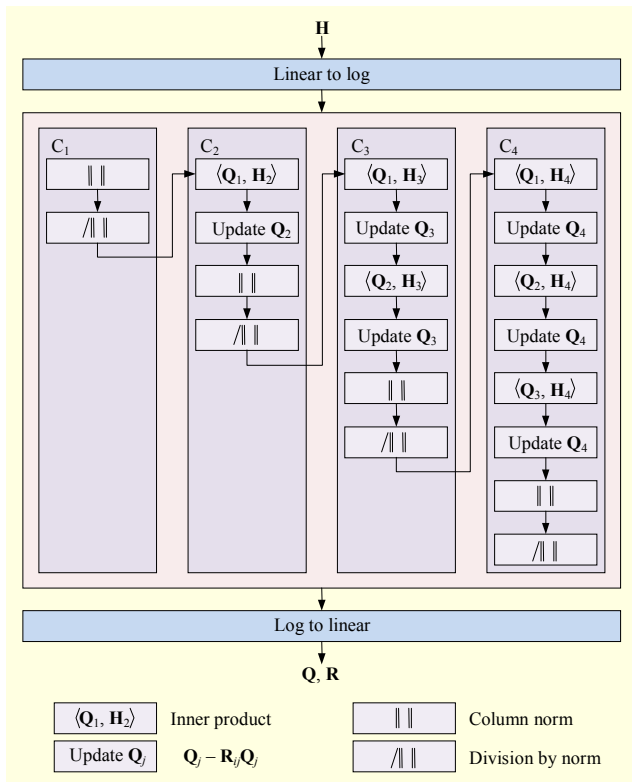

Fig. 11. Block diagram for QRD based on modified Gram-Schmidt algorithm.

The ESIC unit performs the enhanced SIC operation, as described from line 6 to line 10 in Fig. 1. For each candidate vector, the squared Euclidean distance calculation unit computes the squared Euclidean distance, as described in line 11 in Fig. 1. Finally, the LLR unit updates the LLR values in (5) by using the SED values obtained in the previous blocks. This corresponds to line 12 in Fig. 1.

The proposed detectors have been designed and synthesized with a 0.13- μm CMOS technology. Table 3 shows a comparison of several 4×4 MIMO detector implementations. It should be mentioned that it is difficult to directly compare several implementations which are developed in different

environments since different parameters and different implementation options can all affect the final implementation results. In order to compare different implementations, [9] used a figure of merit (FOM) which is defined as

$$\text{FOM} \cong K \times \frac{\text{Throughput (Mbps)}}{\text{Area (KGE)}} \quad (8)$$

Unfortunately, the proposed methods are not based on the *K*-best method, and there are no *K* values for the MESIC and ESIC methods.

For a more direct comparison, we implemented not only the proposed ESIC and MESIC algorithms, but also the *K*-best and the OSIC algorithms. The last 4 columns of Table 3 represent our synthesis results, where we used the same modulation scheme (16 QAM), clock frequency (150 MHz), technology library (0.13 μm), and bit precisions.

As might be expected, the ESIC method occupies more area than the OSIC method as it requires multiple (that is, 4) OSIC blocks. The area of the ESIC method, however, is only 169% (not 400%) because the other blocks, including the QRD block, can be shared. On the other hand, the performance improvement is significant as can be seen in Fig. 5. Thus, considering the results in Fig. 5 and Table 3, it can be said that the ESIC method is a very good solution in terms of performance and area for hard decoding systems.

Although the area required by the MESIC method is nearly four times as large as that required by the ESIC method, it is still based on the simple OSIC algorithm, and as a result, it requires less area than the *K*-best method. It should be noted that the *K*-best method requires large sorting blocks that select *K* minimum numbers among $K \times |\Omega|$ candidates, whereas the MESIC method requires small sorting blocks that select the minimum number (that is, one minimum number) among N_T or $|\Omega|$ candidates. Thus, considering the results in Figs. 6 and 7, it can be said that the MESIC method is a very good solution for soft decoding systems.

In Table 3, it can be also seen that the FOM of our *K*-best implementation is higher than those of the other *K*-best

implementations. Although the area of our K -best implementation is very large, the throughput is also very high when compared with other K -best implementations. Thus, it can be indirectly concluded that the MESIC method yields a better solution even when it is compared with other K -best implementation results.

V. Conclusion

Although the ESIC method is based on the OSIC method, it shows significantly better performance because it solves the error propagation problem inherent in the original OSIC algorithm. By efficiently combining the ESIC method with a multiple-channel-ordering technique, the MESIC method can obtain all the LLR values without using an LLR estimation method, and thus it shows very good FER performance. The MESIC method also requires a small number of candidate symbol vectors and small sorting blocks. As a result, the MESIC method is very efficient in terms of both performance and area, especially in soft decoding systems.

References

- [1] A.J. Paulraj et al., "An Overview of MIMO Communications: A Key to Gigabit Wireless," *Proc. IEEE*, vol. 92, no. 2, Feb. 2004, pp. 198-218.
- [2] G.J. Foschini, "Layered Space-Time Architecture for Wireless Communication in a Fading Environment When Using Multiple Antennas," *Bell Lab. Technical J.*, vol. 1, no. 2, Aug. 1996, pp. 41-59.
- [3] Y. Dai, S. Sun, and Z. Lei, "A Comparative Study of QRD-M Detection and Sphere Decoding for MIMO-OFDM Systems," *Proc. IEEE Int. Symp. Personal, Indoor and Mobile Radio Commun.*, Sept. 2005, pp. 186-190.
- [4] L. Barbero and J. Thompson, "A Fixed-Complexity MIMO Detector Based on the Complex Sphere Decoder," *Proc. IEEE Int. Workshop Signal Process. Advances Wireless Commun.*, July 2006, pp. 1-5.
- [5] Z. Guo and P. Nilsson, "Algorithm and Implementation of the K -Best Sphere Decoding for MIMO Detection," *IEEE J. Sel. Areas Commun.*, vol. 24, no. 3, Mar. 2006, pp. 491-503.
- [6] M. Wenk et al., " K -Best MIMO Detection VLSI Architectures Achieving up to 424 Mbps," *Proc. IEEE Int. Symp. Circuits Syst.*, May 2006, pp. 1151-1154.
- [7] S. Chen, T. Zhang, and Y. Xin, "Relaxed K -Best MIMO Signal Detector Design and VLSI Implementation," *IEEE Trans. VLSI Syst.*, vol. 15, no. 3, Mar. 2007, pp. 328-337.
- [8] K. Kim et al., "A QRD-M/Kalman Filter-Based Detection and Channel Estimation Algorithm for MIMO-OFDM Systems," *IEEE Trans. Wireless Commun.*, vol. 4, no. 2, Mar. 2005, pp. 710-721.
- [9] S. Mondal et al., "Design and Implementation of a Sort-Free K -Best Sphere Decoder," *IEEE Trans. VLSI Syst. (online)*, 2009.
- [10] C.A. Shen and A.M. Eltawil, "A Radius Adaptive K -Best Decoder with Early Termination: Algorithm and VLSI Architecture," *IEEE Trans. Circuits Syst. I (online)*, 2010.
- [11] T.H. Im et al., "A New Signal Detection Method for Spatially Multiplexed MIMO Systems and its VLSI Implementation," *IEEE Trans. Circuits Syst. II*, vol. 56, no. 5, May 2009, pp. 399-403.
- [12] B.M. Hochwald and S. Brink, "Achieving Near-Capacity on a Multiple-Antennas Channel," *IEEE Trans. Commun.*, vol. 51, no. 3, Mar. 2003, pp. 389-399.
- [13] C. Studer, A. Burg, and H. Bölcskei, "Soft-Output Sphere Decoding: Algorithms and VLSI Implementation," *IEEE J. Sel. Areas Commun.*, vol. 26, no. 2, Feb. 2008, pp. 290-300.
- [14] A. Burg et al., "VLSI Implementation of MIMO Detection Using the Sphere Decoding Algorithm," *IEEE J. Solid-State Circuits*, vol. 40, no. 7, July 2005, pp. 1566-1577.
- [15] M. Sitti and M. Fitz, "A Novel Soft-Output Layered Orthogonal Lattice Detector for Multiple Antenna Communications," *Proc. IEEE ICC*, vol. 4, June 2006, pp. 1686-1691.
- [16] W. Choi, R. Negi, and J.M. Cioffi, "Combined ML and DFE Decoding for the V-BLAST System," *Proc. IEEE ICC*, 2000, pp. 1243-1248.
- [17] E.W. Jang et al., "Improved OSIC Decoder for Spatially Multiplexed System," *Proc. IEEE ICC*, 2006, pp. 2963-2968.
- [18] C.K. Singh, S.H. Prasad, and P.T. Balsara, "VLSI Architecture for Matrix Inversion Using Modified Gram-Schmidt Based QR Decomposition," *Proc. Int. Conf. VLSI Design*, Jan. 2007, pp. 836-841.



Tae Ho Im received the BS and MS degrees in electrical and electronics engineering from Chung-Ang University, Seoul, Rep. of Korea, in 2006 and 2008, respectively. He is currently working toward the PhD in electrical and electronics engineering from Chung-Ang University, Seoul, Korea. His current research interests include signal processing and wireless communication, especially for MIMO-OFDM and signal detection.



Insoo Park received the BS and MS in electrical and electronics engineering from Chung-Ang University, Seoul, Rep. of Korea, in 2007 and 2009, respectively. His research interests include application-specific IC design and high-performance digital circuit design for communication and DSP applications.

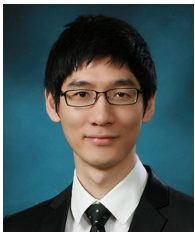

Hyun Jong Yoo received the BS in electrical and electronics engineering from Chung-Ang University, Seoul, Rep. of Korea, in 2011. He is currently working toward the MS in electrical and electronics engineering from Chung-Ang University, Seoul, Rep. of Korea. His research interests are in the area of wireless communication, especially for MIMO-OFDM.



Sungwook Yu received the BS in electrical engineering from Seoul National University, Seoul, Rep. of Korea, in 1992. He received the MS and PhD in electrical and computer engineering from the University of Texas at Austin, in 1996 and 2000, respectively. From 1999 to 2000, he worked at SiLogiX in Austin, TX, and from 2000 to 2004, he worked at Intel Corp. in Austin, TX. He worked for a year at Samsung Semiconductor Inc., Rep. of Korea, before joining the faculty of electrical and electronics engineering department in Chung-Ang University, Seoul, Rep. of Korea, in 2005. His research interests include application-specific IC design for communication and digital image/video processing applications.



Yong Soo Cho received the BS in electronics engineering from Chung-Ang University, Seoul, Rep. of Korea, the MS in electronics engineering from Yonsei University, Seoul, Rep. of Korea, and the PhD in electrical and computer engineering from the University of Texas at Austin, in 1984, 1987, and 1991, respectively. During 1984 he was a research engineer at Goldstar Electrical Company, Osan, Rep. of Korea. In 1992, he joined Chung-Ang University, where he is currently a professor at the School of Electrical and Electronic Engineering. His research interests are in the area of wireless communication, especially for MIMO-OFDM.