

Preparation and Adsorption Properties of PA6/PSMA-OA Molecularly Imprinted Composite Membranes in Supercritical CO₂

Qing Zhang, Xingyuan Zhang,* Wencheng Zhang,^{†,*} Jian Pan,[†] Ling Liu,[†] Haitao Zhang,[†] Dong Zhao, and Zhi Li

CAS Key Laboratory of Soft Matter Chemistry, Department of Polymer Science and Engineering, University of Science and Technology of China, Hefei 230026, P.R. China. *E-mail: zxym@ustc.edu.cn

[†]Engineering Research Center of Bio-process, Ministry of Education, Hefei University of Technology, Hefei 230009, P.R. China
*E-mail: zwc1012@163.com

Received June 9, 2011, Accepted July 27, 2011

Oleanolic acid (OA) as template molecule, polyamide-6 (PA6) as basement membrane and poly(styrene-co-maleic acid) (PSMA) were used to prepare PA6/PSMA-OA molecularly imprinted composite membranes by phase inversion method in supercritical CO₂ (ScCO₂). The template molecule (OA), [poly(styrene-co-maleic anhydride) (PSMAH), PSMA, molecularly imprinted membranes (MIMs) imprinting OA and MIMs after elution were all characterized by Fourier transform infrared spectroscopy (FTIR). The conditions that were the mass ratio between PSMA and OA from 3:1 to 8:1, temperature of ScCO₂ from 35 °C to 50 °C and pressure of ScCO₂ 12 MPa to 17 MPa were studied. It was obtained the largest adsorption rate and purity of OA after adsorption of the resultant MIMs, 50.41% and 96.15% respectively. After using PA6 film and non-woven fabrics as basement membrane respectively, it was found that smaller aperture of PA6 was used as basement membrane, a higher adsorption rate and a higher purity of OA after adsorption of the MIMs were obtained, and so were the stability and reproducibility of the resultant MIMs. After template molecules being removed, the MIMs had effective selectivity hydrogen bonding to separately bind in the binary components to the template molecules-oleanolic acid.

Key Words : Oleanolic acid, Supercritical carbon dioxide, Phase inversion, Molecularly imprinted composite membrane, Binding experiment

Introduction

Molecularly imprinted membrane (MIM) has the advantages of both molecular imprinting technique and membrane separation technology. In recent years, MIM has aroused general interest in the research field of molecular imprinting technology. Selective separation of individual substance could not be achieved by using the current commercial membranes, such as ultrafiltration film, microfiltration film and reverse osmosis film. However, MIM could be used as a new approach to selectively recognize some specific molecules in complicated system.

The main methods to prepare MIMs include phase inversion in the presence of template molecules,¹⁻⁴ surface imprinting⁵⁻⁷ and in situ polymerization by bulk polymerization.^{8,9} However, MIMs preparation by phase separation with supercritical CO₂ (ScCO₂) as non-solvent has shown many advantages. The diffusion coefficient of organic solvent in ScCO₂ liquid is higher by 1-2 orders of magnitude than that of traditional liquid solvent. Mass transfer rate is accelerated between solvent and non-solvent, which speeds up the rate of phase separation, hence obtains the sub-micron materials. Besides, there is no residue after CO₂ evaporation, so additional components could not be introduced into the prepared materials. ScCO₂ has a very wide range of applications, such as adding additives into the polymer in processing,^{10,11} acting as a medium in polymerization,¹² and

as a swelling agent in the preparation of polymer microspheres, micro-fibers,¹³ polymer blends and composite materials.¹⁴⁻¹⁶

Generally speaking, if water was used as a coagulation medium to build tailor-made imprinted sites of the template during the molecular imprinting processes,¹⁷ owing to the high solubility of the template in water, the strength of the resulting membrane and the limited numbers of the imprinted sites for the template, the binding capacity of the resulting membrane was reduced.³ Zhang *et al.*¹⁸ used poly(acrylonitrile-co-methacrylic acid) in compressed liquid CO₂ to prepare porous imprinted membranes which preferentially adsorbed uracil (URA) (P(AN-co-MAA)-URA MIMs) by phase separation. The tensile strength of P(AN-co-MAA)-URA MIMs prepared in liquid CO₂ (4.4 N·mm⁻²) was much higher than that of P(AN-co-MAA)-URA MIMs prepared in water (0.7 N·mm⁻²). Binding experiment also confirmed that the resulting membranes were a better adsorbent of URA than that prepared in water. Kobayashi *et al.*¹⁹ used poly(styrene-co-maleic acid) (PSMA) in ScCO₂ to prepare molecularly imprinted membranes for targeted URA (PSMA-URA MIMs). ScCO₂ was efficient to fix the shape of URA template into the PSMA membranes through hydrogen bonding. Results showed that PSMA-URA MIMs prepared at 50 °C were highly recognized and selectively bound to URA than the case at 35 °C. The separation and extraction of oleanolic acid (OA, Figure 1) and its isomer

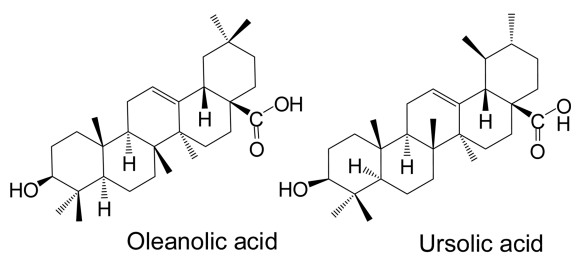

Figure 1. Chemical structure of oleanolic acid and ursolic acid.

ursolic acid, conventional solvent extraction and column chromatography were generally used, however, these methods have complicated steps, a large solvent consumption and serious pollution to the environment.^{20,21}

In view of the problems, poly(styrene-co-maleic acid) was used to prepare oleanolic acid molecularly imprinted composite membranes (PA6/PSMA-OA MIMs) in this paper. The molecularly imprinted process was illustrated in Figure 2. Because of some good properties of PSMA, such as solubility, filming, miscibility, easy modification of its carboxyl groups and the ability of styrene to form membrane, it is suitable to prepare MIM by noncovalent bonding. Meanwhile, the resulting membrane has extensive application value. It was found that PA6/PSMA-OA MIMs had a good selective adsorption for OA. When the mass ratio of PSMA and OA was 6:1, the temperature and pressure of ScCO_2 were 40 °C and 15 MPa, the best adsorption properties of MIMs could be obtained.

Experimental

Materials and Reagents. Poly(styrene-co-maleic anhydride) (PSMAH, M_w : 224,000) was obtained from Sigma-Aldrich. Polyamide-6 film was purchased from Taizhou Luqiao Sijia Biochemical Plastic plant (Zhejiang, China); non-woven fabrics (polyester fiber, TA3631) from Shanghai Tianlue Industrial Textile Co. Ltd (Shanghai, China); oleanolic acid and ursolic acid from Changsha Staherb

Natural Ingredients Co. Ltd (Hunan, China). High purity (99.9%) carbon dioxide (CO_2) used for production of compressed liquid CO_2 was supplied by Hefei Henglong Electric Technique Co. Ltd (Anhui, China). Before use, all the chemicals were further purified.

Preparation of Membranes in ScCO_2 . To obtain interactive sites of oleanolic acid template in PSMA, hydrolysis of PSMAH was carried out as follows. 5 g of PSMAH was added into 60 mL of tetrahydrofuran (THF) in a three-neck flask. The solution was stirred until all PSMAH dissolved. Then, 3 mol/L of NaOH solution was added slowly into the flask and refluxed at 80 °C for 2 hours. The solution was precipitated in 3 mol/L of HCl solution, then the resultant white polymer was washed with large amount of distilled water for 3 times. The polymer was vacuum dried to obtain PSMA. The hydrolysis process of PSMAH to PSMA containing change of chemical structure is shown in Figure 3.

Porous imprinted membranes were prepared by phase separation using ScCO_2 as nonsolvent. Figure 4 schematically illustrates the procedure used for preparation of PA6/PSMA-OA or non-woven fabric/PSMA-OA molecularly imprinted composite membranes. PSMA and OA were dissolved in *N,N*-dimethylformamide (DMF), and stirred in a water bath at 60 °C for 2 days to form the casting solution. After being spread by the cast solution, the whole of poly-

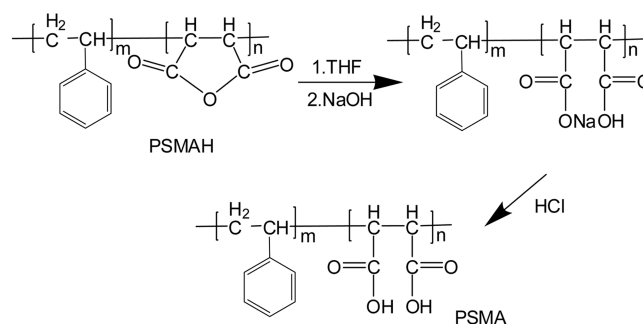

Figure 3. Hydrolysis of PSMAH to PSMA.

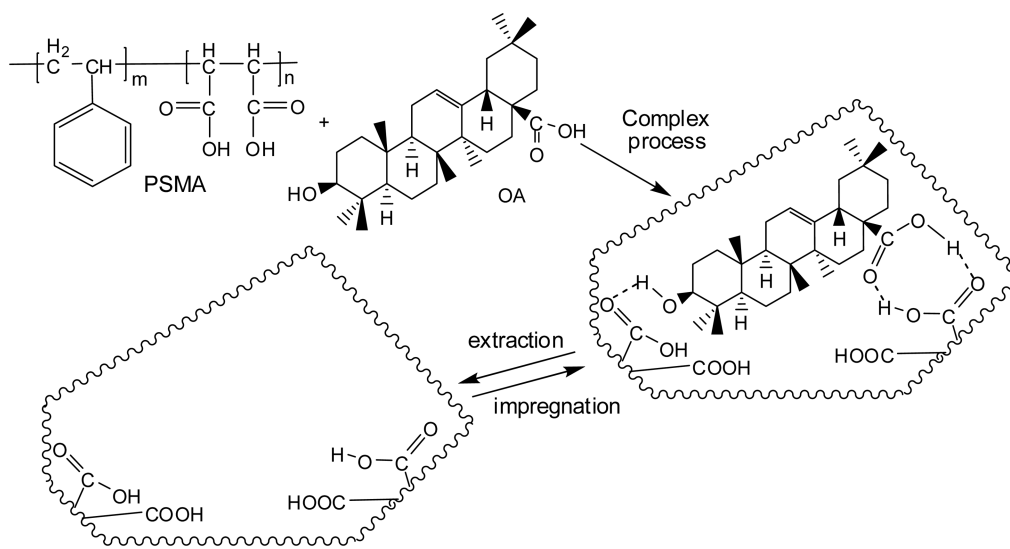

Figure 2. Illustration of PSMA imprinting process with OA.

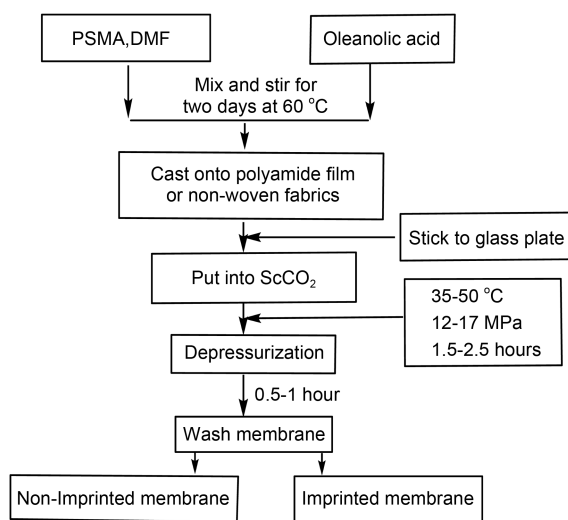
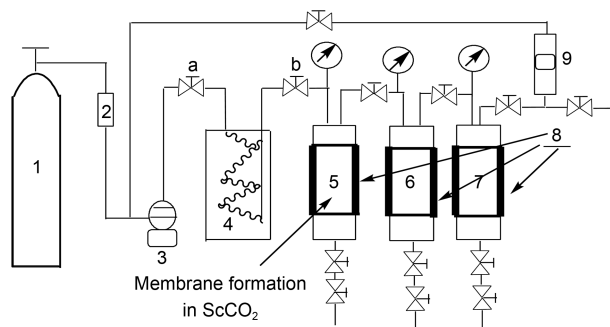

Figure 4. Process for preparation of molecularly imprinted composite membranes.



1. Gas vane, 2. Filter, 3. Compressor, 4. Hot exchanger, 5. Extraction container, 6. Separation container I, 7. Separation container II, 8. Water bath, 9. Flowmeter, a. Booter

Figure 5. The experimental apparatus for preparation of imprinted membranes in ScCO₂ and adsorption.

amide film or non-woven fabric was pasted to a suitable glass plate. Then the glass plate was rapidly put into extraction container (5 in Figure 5), which was preheated to desired temperature. The self-made experimental apparatus for preparation of imprinted membrane in ScCO₂ was shown in Figure 5. The operation process could be described as follows: (i) opened valve a and closed valve b, and liquid CO₂ was pumped into the extraction container from gas cylinder through a high-pressure pump. (ii) the extraction container was then filled with pumping CO₂ up to the desired pressure and desired temperature. (iii) when both of the pressure and temperature were satisfied with the requirement and stable, closed valve a. The system was maintained for 1.5-2.5 hours to form solid polymer. (iv) then, the system was slowly depressurized by opening valve b for about 0.5 h at the experimental temperature. As soon as the depressurization process was finished, the membrane was taken out. The OA template involved in the resultant membranes was extracted with methanol and large quantity of distilled water for 3 days at room temperature, until OA could not be

detected in the extracting solution by high performance liquid chromatography (HPLC). After complete removal of OA template, the membranes were vacuum dried. For non-imprinted membranes, the preparation procedure was the same as that for OA-imprinted membranes except that there were no OA template molecules in the casting solution.

Membrane Properties and Binding Experiments. The imprinted membranes prepared in ScCO₂ were characterized by Fourier transform infrared spectroscopy (FTIR) with a Nicolet-8700 spectrophotometer (Thermo Scientific Instrument Co., U.S.A).

The binding experiments of imprinted membranes were carried out as follows:

(i) 0.5 g OA (purity of 50%) was added into 20 mL of ethanol (used as entrainer) in a breaker. After stirring with a glass rod, both of OA and ethanol were poured into extraction container (5 in Figure 5).

(ii) Then MIMs were also put into extraction container.

(iii) Opened all the valves, and liquid CO₂ was pumped into the system through a high-pressure pump. The desired pressure 14 MPa in extraction container was achieved by controlling the flow rate of valve b. Then the device of water bath (8 in Figure 5) was opened to make extraction container up to the desired temperature 40 °C.

(iv) The whole system was in a dynamic process and maintained for 2 hours. It is important to control the flow rate of flowmeter (9 in Figure 5).

(v) The system was slowly depressurized and CO₂ could be recycled into the empty bottle.

(vi) After being taken out, the molecularly imprinted membranes were eluted with eluant. Then the eluant was evaporated completely to attain required solid substances. The substances were weighed and prepared to be a certain concentration solution. The purity of OA was detected by HPLC.

(vii) A series of OA standard solutions were prepared for the standard curve. Agilent 1100 series HPLC system (Agilent, USA) was operated at 210 nm. HPLC analysis was performed on Waters Symmetry Shield C₁₈ column (3.9 mm × 300 mm, 4 μm, Waters, USA) at a temperature of 25 °C and a flow rate of 1.0 mL/min. The mobile phase was composed of acetonitrile and water (v/v, 90:10). A very good linear relationship between sample volume and peak area was obtained, with a correlation coefficient (r^2) of 0.999 in the range of 0.03-0.6 mg/mL.

(viii) The solutions in (vi) were detected by HPLC and the purities of OA were calculated by the standard curve.

Results and Discussion

Characteristic of Imprinted Membranes. The FT IR spectra of OA, PSMAH, PSMA, MIM imprinted with OA and MIM after extraction were shown in Figure 6. In (a), the bands at 1686 and 3421 cm⁻¹ were characteristic to OA, which showed the stretching vibration adsorption of O-H and C=O groups, respectively. As shown in (b) and (c), the hydrolysis reaction of PSMAH to PSMA was monitored by

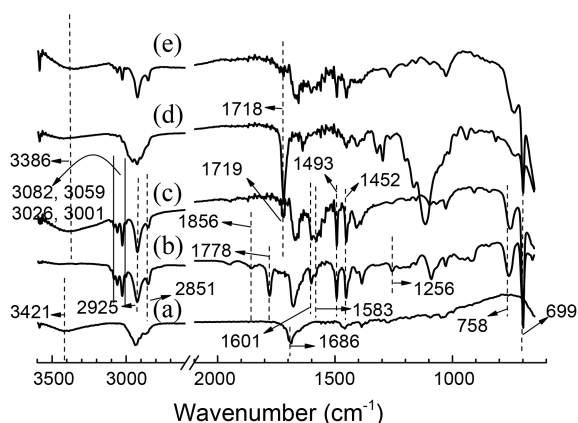

Figure 6. FT IR spectra of OA (a), PSMAH (b), PSMA (c), MIM imprinted with OA (d) and MIM after extraction (e).

infra-red analysis. The adsorptions at 3082, 3059, 3026, 3001 cm^{-1} were the stretching vibration of C-H of the phenyl groups. The asymmetrical and symmetrical stretching vibration adsorptions of C-H were 2925 and 2851 cm^{-1} , respectively. The IR bands at 1601, 1583, 1493, 1452 cm^{-1} were the stretching vibration of C=C of phenyl groups on the backbone. The adsorptions at 758 and 699 cm^{-1} were the bending vibration of C=C of the phenyl groups. The characteristic adsorptions at 1856 and 1778 cm^{-1} (b) were the asymmetrical and symmetrical carbonyl adsorption of anhydride groups, respectively. The peak intensity of the high wave number at 1856 cm^{-1} is much weaker than that the lower frequency at 1778 cm^{-1} , which is one of the remarkable features of five-membered cycloanhydride. The 1256 cm^{-1} band was attributed to the C-O-C stretching vibration adsorption of maleic anhydride units. After hydrolysis completed, it was clearly shown on (c) spectrum that the carbonyl stretching of anhydride band was changed into carboxylic acid band at 1719 cm^{-1} , and the peaks due to the unreacted anhydride groups were clearly disappeared at 1778 and 1856 cm^{-1} . The IR band at 3386 cm^{-1} was O-H stretching vibration of carboxylic acid groups. Compared with the OA spectrum (a), the adsorption of C=O group (d) shifted toward higher wave number at 1718 cm^{-1} and the peak intensity was strengthened notably, indicating that O-H and COOH groups of OA interacted with COOH segment of PSMA. In addition, the 1718 cm^{-1} adsorption in (e) disappeared after completed extraction of OA. In (d), the peak intensity was lower than that observed in the spectrum (e) at 3386 cm^{-1} of O-H stretching vibration of COOH group in PSMA. This implied that the inter- or intra- molecular hydrogen bonding between COOH segments of PSMA was disrupted by the added OA template molecules (Figure 7).

Influencing factors on preparation of PA6/PSMA-OA MIMs. From the supercritical temperature, supercritical pressure and the mass ratio between PSMA and template molecules-OA, three factors on preparation of polyamide-6/poly(styrene-co-maleic acid)-oleanolic acid molecularly imprinted composite membranes (PA6/PSMA-OA MIMs) were investigated in this article. Then the resultant mem-

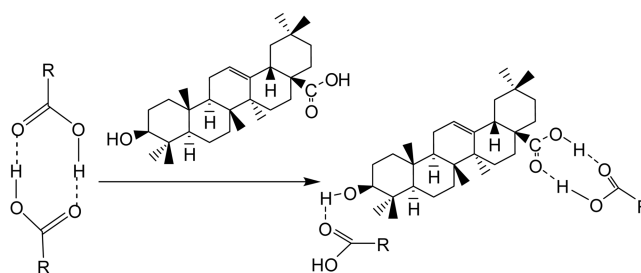

Figure 7. Illustration of hydrogen bonds between OA template and COOH segment of PSMA.

branes were studied in the supercritical equipment for the adsorption of oleanolic acid (50% of purity). The adsorption rate of MIMs and the purity of OA after adsorption are the basis to judge the performance of membranes.

The effect of temperature on the mechanism of ScCO_2 is quite complex, in other words, the temperature is a critical factor in the formation of molecular imprinted membranes. Generally, with the increase of temperature, the solubility of substance in ScCO_2 is often the lowest. The effect of temperature on the solubility of substance in ScCO_2 could be interpreted from two aspects: i) The effect of temperature on ScCO_2 density is that CO_2 fluid density decreases as the temperature rises, resulting in decrease of CO_2 fluid solvent effect, so the solubility of substance decreases. ii) The impact of temperature on vapor pressure of substance is that vapor pressure of substance increases as the temperature rises, so the solubility of substance in ScCO_2 increases. In Figure 8, at 40 $^\circ\text{C}$, the adsorption rate and the purity of OA after adsorption of the resultant molecularly imprinted membranes are the highest. The reason is that under low temperature, DMF in casting solution could not be dissolved well in CO_2 fluid because of poor CO_2 fluid solvent effect, resulting in the resultant MIMs are not regular, and imprinted sites are not enough after elution. Nevertheless, the temperature is so high that DMF is quickly dissolved in ScCO_2 . That is the solvent was taken away quickly, and the pore of the resultant membranes is uneven. And the higher the temperature the more serious this heterogeneity, imprinted sites could not reach the standard requirements.

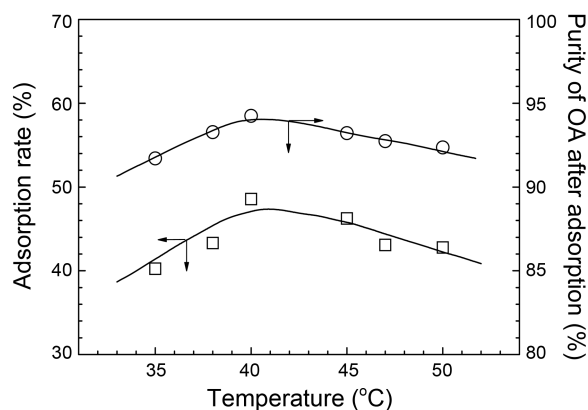

Figure 8. Influence of temperature on preparation of PA6/PSMA-OA MIMs.

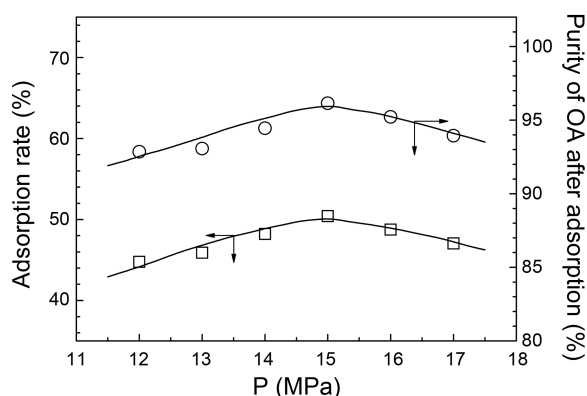

Figure 9. Influence of pressure on preparation of PA6/PSMA-OA MIMs.

So at 40 °C, the adsorption rate of OA came up to 48.56% and the purity of OA reached 94.25% from 50% of the resultant MIMs.

The impact of pressure on the mechanism of the ScCO₂ is one of the key factors. Generally, with the pressure of ScCO₂ increasing, the solubility of substances in it showed a sharp increase phenomenon, which means that with the increase of pressure, the solubility of DMF in ScCO₂ increases gradually, but it is not very good for the formation of MIMs while DMF dissolved more easily. Therefore, in Figure 9, it appeared a highest point at 15 MPa, which indicated that the optimum pressure of the formation of MIMs is 15 MPa. Because 15 MPa is not only a suitable pressure that DMF dissolved in ScCO₂, but also a better pressure that the interaction between polyamide film and MIMs. Too high pressure not only destroyed the membrane pore of polyamide film to decrease its supporting role, but also weakened the interaction between polyamide film and MIMs. The ultimate result was to affect the quality of PA6/PSMA-OA MIMs and the observation of those adsorption properties for OA.

Another important factor on morphology and properties of membrane structure is polymer concentration. The polymer concentration in casting solution is generally in the range of 10%-20%. The strength of membrane is too bad when the concentration is too low; when the concentration is too high, polymer does not dissolve very well, and membrane defect is easy to appear and membrane reproducibility is poor. In Figure 10, at first, with the mass ratio of PSMA and OA increasing, the adsorption rate of MIMs and the purity of OA after adsorption increased. It was that with the increase of polymer concentration, the surface thickness of the resultant membranes would be increased, the porosity and the degree of interconnection between the pores could be declined, and the pore size was decreased. At the same time the increase of polymer concentration could eliminate the formation of macroporous and decrease permeability. However, the mass ratio of PSMA and OA was more than 6:1, the adsorption rate of MIMs and the purity of OA after adsorption were getting lower with the mass ratio increasing. It indicated that polymer didn't dissolve very well in the casting solution so that the resultant membrane had some defects. Additionally,

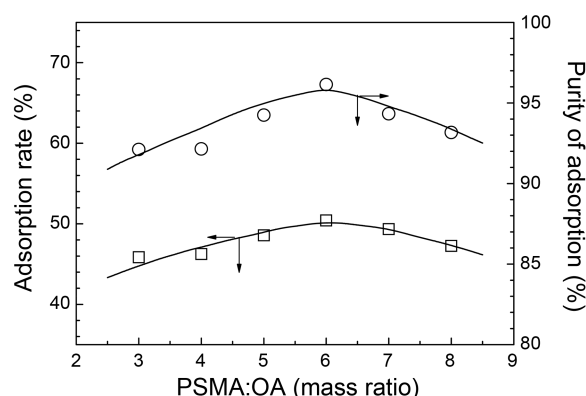

Figure 10. Influence of the mass ratio of PSMA and OA on preparation of PA6/PSMA-OA MIMs.

water is non-solvent for polymer materials, whereas water absorption is in some polar polymer materials and polar solvents, so water content should be paid attention to. Therefore, polymer materials should be dried before the configuration of casting solution, even purified when necessary. In order to dissolve polymer completely, a curing process for casting solution with efficient stir (2-4 times one day) is also required, which is generally 3-5 days, so that the chain of polymer materials could extend fully to reduce visible holes.

Binding of PA6/PSMA-OA MIMs for OA and UA. To estimate the selective binding of OA imprinted membranes prepared in ScCO₂, the analogue of OA-ursolic acid (UA) was used in the reference experimental study of adsorption. In Figure 11, the adsorption rate of PA6/PSMA-OA MIMs for OA and the purity of OA after adsorption were 50.41% and 96.15%, respectively, significantly higher than those of UA. Especially, from the comparison of purities of OA and UA after adsorption, it was concluded that template molecules interacted with polymer through hydrogen bond in the imprinting process. After elution, the pores of template molecules were formed in imprinted membranes. So they had very high adsorption performance for OA, not having recognition sites of identification characteristic for its

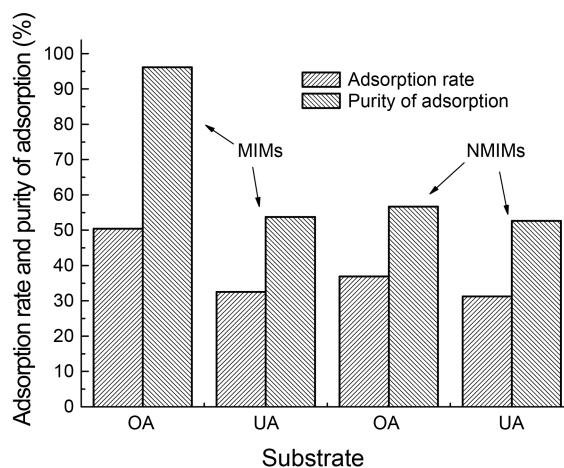

Figure 11. Binding of different substrates to the PA6/PSMA-OA MIMs and NMIMs.

Table 1. Reproducibility of non-woven fabrics/PSMA-OA MIMs and PA6/PSMA-OA MIMs

MIM Type	I		II		III		Reproducibility	
	Ar	Pa	Ar	Pa	Ar	Pa	II/I	III/II
Non-woven fabrics/PSMA-OA MIM	42.5	92.78	38.25	91.39	36.5	89.8	98.5	98.3
PA6/PSMA-OA MIM	50.41	96.15	49.36	95.48	48.5	94.8	99.3	99.3

Ar: Adsorption rate (%); Pa: Purity of OA after adsorption (%)

analogue-UA. The adsorption rates and the purities after adsorption of PA6/PSMA-OA NMIMs for OA and UA were both low and the differences among the values were very little. This implied that the selective recognition sites did not exist in the structure of non-imprinted membranes, and the adsorption for the two substrates were non-selective adsorption. The recognition of OA molecules by OA molecularly imprinted membranes depends primarily on two parameters: i) the size of template molecules, ii) the match of bonding position. From the comparison of structures of two substances (Figure 1), it was clear that the spatial dimension of UA isn't coordinated with the size of the imprinted 'hole', and its bonding position can not match, resulting in that the molecules fall off easily, so the selectivity is much lower than that of OA.

Reproducibility of Two Kinds of MIMs. In order to study the stability and reproducibility of the MIMs, three cycles of adsorption/elution/regeneration were performed, using different MIMs of base film. The results listed in Table 1 indicate that two kinds of MIMs are stable, especially the adsorption capacity of PA6/PSMA-OA molecularly imprinted composite membranes could be maintained at almost one constant value.

Binding of Membranes. As shown in Figure 12, the differences between the adsorption rate of several membranes for OA in ScCO₂ were not significant. The adsorption rates of polyamide films (45.22%, 46.89%, 50.41%) were

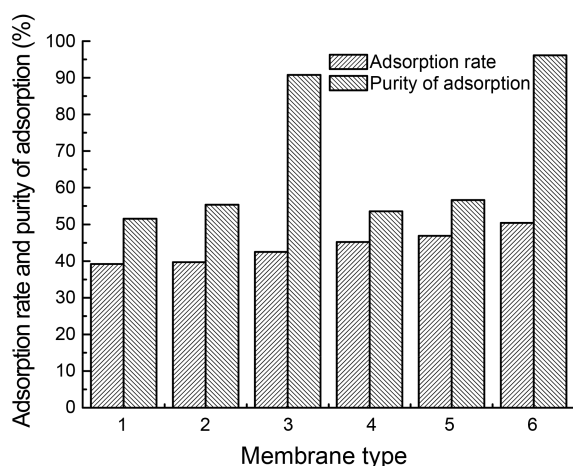

1. Non-woven fabrics, 2. Non-woven fabrics/PSMA-OA NMIMs, 3. Non-woven fabrics/PSMA-OA MIMs, 4. Polyamide films, 5. PA6/PSMA-OA NMIMs, 6. PA6/PSMA-OA MIMs

Figure 12. Binding of six kinds of membranes.

slightly higher than those of non-woven fabrics (39.18%, 39.68%, 42.50%). This indicated that membrane materials and the properties of membranes had little effect on the adsorption rate, and the adsorption rate was mainly affected by the affinity between materials and OA and the size of molecules, little by molecular imprinting 'hole'. However, a great difference was found after comparing with the purities of OA after adsorption. The purities of OA after adsorption by non-woven fabrics/PSMA-OA MIMs and PA6/PSMA-OA MIMs were 90.78% and 96.15%, but those after adsorption by polyamide films, non-woven fabrics and non molecularly imprinted membranes were only a little more than 50%, just a little higher than that of original OA. This indicated that recognition sites to identify OA molecules were formed in the two molecularly imprinted membranes. And it was further concluded that the purity of OA after adsorption was affected by the surface special structural 'hole' of molecularly imprinted membranes. In addition, the purity of OA after adsorption by PA6/PSMA-OA MIMs was higher, because the surface of polyamide film is flatter and its aperture is smaller than that of non-woven fabrics. So it could be used as a kind of excellent basement membrane materials.

Conclusions

In the present work, PA6/PSMA-OA molecularly imprinted composite membranes were successfully prepared in ScCO₂ by phase inversion method. The ScCO₂ was efficient to fix the shape of OA template molecules into PSMA membrane through hydrogen bonding. Under the conditions that mass ratio of PSMA and OA 6:1, temperature of ScCO₂ 40 °C, and pressure of ScCO₂ 15 MPa, the largest adsorption rate and purity of OA after adsorption of the resultant MIMs were 50.41% and 96.15%, respectively. After measuring the polyamide film (PA6) and the non-woven fabrics as basement membrane respectively, it was found that smaller aperture of PA6 was used as the basement membrane, the higher adsorption rate and the higher purity of OA after adsorption of the MIMs were obtained, and so were the stability and reproducibility of the resultant MIMs. After completing removal of template molecules from the molecularly imprinted membranes, the MIMs had effective selective recognition for OA. Therefore, the preparation of OA imprinted membranes provided a feasible method to separate OA from compounds electively. Further work on this subject requires to study the conditions of the binding of PA6/PSMA-OA MIMs, such as time in the ScCO₂, temperature

of ScCO₂, pressure of ScCO₂, the impact of entrainer and so on.

Acknowledgments. Financial supports from the National Natural Science Foundation of China (No. 20974108), China Postdoctoral Science Foundation (No.20070410216) and Natural Science Foundation of Anhui Province, China (No. 11040606M191) are acknowledged.

References

1. Trotta, F.; Drioli, E.; Baggiani, C.; Lacopo, D. *J. Membr. Sci.* **2002**, *201*, 77-84.
 2. Kobayashi, T.; Fukaya, T.; Abe, M.; Fujii, N. *Langmuir* **2002**, *18*, 2866-2872.
 3. Screenivasulu Reddy, P.; Kobayashi, T.; Abe, M.; Fujii, N. *Eur. Polym. J.* **2002**, *38*, 521-529.
 4. Ramamoorthy, M.; Ulbricht, M. *J. Membr. Sci.* **2003**, *217*, 207-214.
 5. Hilal, N.; Kochkodan, V. *J. Membr. Sci.* **2003**, *213*, 97-113.
 6. Piletsky, S.-A.; Matuschewski, H.; Schedler, U.; Wilpert, A.; Piletska, E.-V.; Thiele, T.-A.; Ulbricht, M. *Macromolecules* **2000**, *33*, 3092-3098.
 7. Sergeeva, T.-A.; Matuschewski, H.; Piletsky, S.-A.; Bendig, J.; Schedler, U.; Ulbricht, M. *J. Chromatogr. A* **2001**, *907*, 89-99.
 8. Mathew-Krotz, J.; Shea, K. *J. Am. Chem. Soc.* **1996**, *118*, 8154-8155.
 9. Sergeeva, T.-A.; Piletska, O.-V.; Piletsky, S.-A.; Sergeeva, L.-M.; Brovko, O.-O.; El'ska, G.-V. *Mater. Sci. Eng., C* **2008**, *28*, 1472-1479.
 10. Berens, A.-R.; Huvard, G.-S.; Korsmeyer, R.-W.; Kunig, F.-W. *J. Appl. Polym. Sci.* **1992**, *46*, 231-242.
 11. von Schnitzler, J.; Eggers, R. *J. Supercrit. Fluids* **1999**, *16*, 81-92.
 12. Sarrade, S.; Guizard, C.; Rios, G.-M. *Sep. Purif. Technol.* **2003**, *32*, 57-63.
 13. Luna-Bárcenas, G.; Kanakia, S.-K.; Sanchez, I.-C.; Johnston, K.-P. *Polymer* **1995**, *36*, 3173-3182.
 14. Watkins, J.-J.; McCarthy, T.-J. *Macromolecules* **1994**, *27*, 4845-4847.
 15. Kung, E.; Lesser, A.-J.; McCarthy, T.-J. *Macromolecules* **1998**, *31*, 4160-4169.
 16. Arora, K.-A.; Lesser, A.-J.; McCarthy, T.-J. *Macromolecules* **1999**, *32*, 2562-2568.
 17. Wang, H.-Y.; Xia, S.-L.; Sun, H.; Liu, Y.-K.; Cao, S.-K.; Kobayashi, T. *J. Chromatogr. B* **2004**, *804*, 127-134.
 18. Zhang, Q.; Kusunoki, T.; Xu, Q.; Wang, H.; Kobayashi, T. *Anal. Bioanal. Chem.* **2007**, *388*, 665-673.
 19. Kobayashi, T.; Leong, S.-S.; Zhang, Q. *J. Appl. Polym. Sci.* **2008**, *108*, 757-768.
 20. Herodez, S.-S.; Hadolin, M.; Skerget, M.; Knez, Z. *Food Chem.* **2003**, *80*, 275-282.
 21. Liu, H.; Shi, Y.; Wang, D.; Yang, G.; Yu, A.; Zhang, H. *J. Pharm. Biomed. Anal.* **2003**, *32*, 479-485.
-