

論文

AE 기법을 이용한 외부수압을 받는 복합재 원통의 균열 검출

박진하*, 최진호*, 권진회**

Crack Detection of Composite Cylinders under external pressure using the Acoustic Emission

Jin-Ha Park*, Jin-Ho Choi*+ and Jin-Hwe Kweon**

ABSTRACT

The studies on the non-destructive testing methods of the composite materials are very important for improving their reliability and safety. AE(Acoustic Emission) can evaluate the defects by detecting the emitting strain energy when elastic waves are generated by the generation and growth of a crack, plastic deformation, fiber breakage, matrix cleavage or delamination. In this paper, the AE signals of the filament wound composite cylinder and sandwich cylinder during the pressure test were measured and analyzed. The signal characteristics of PVDF sensors were measured, and an AE signal analyzer which had the band-pass filter and L-C resonance filter were designed and fabricated. Also, the crack detection capability of the fabricated AE signal analyzer was evaluated during the pressure tests of the filament wound composite cylinder and the sandwich cylinder.

초 록

복합재료의 비파괴 검사 방법에 관한 연구는 복합재료의 신뢰성 및 안전성을 개선시키는데 매우 중요하다. AE기법은 소성변형, 섬유파손, 모재균열 또는 박리에 의해 생성되는 탄성파에서 감지되는 변형 에너지를 감지하여 결함을 평가 하는 기법이다.

본 논문에서는 외부 수압을 받는 필라멘트 와인딩 복합재 원통과 샌드위치 원통의 수압시험이 수행되었고, PVDF센서로부터 측정된 AE 신호특성을 분석하였다. 또한, L-C 동조회로와 Band-pass filter 회로를 가진 AE 신호분석기를 설계, 제작 하였으며, 필라멘트 와인딩 원통과 샌드위치 원통에 대한 수압시험에서 제작된 AE 신호분석기의 균열 검출 능력을 평가하였다.

Key Words : 복합재 원통(Composite cylinder), AE(acoustic emission), PVDF(polyvinylidene fluoride)

1. Introduction

The invisible inner damage of the composite materials can be oriented by residual stresses during the curing process or by overload during operation. These defects range from the submicron level to several millimeters in dimension, and often have a great effect on the reliability and stability of

composite structures. It is very important to measure the sizes of these defects and to decide their tolerance ranges[1]. Also, if the generation, growth, and accumulation process of these defects within composite materials can be revealed by a micro-mechanical analysis and non-destructive tests, the strength, fracture toughness and residual life can be evaluated more accurately[2-6]. AE(Acoustic Emission) can evaluate

* 경상대학교 항공우주특성화 대학원

*+ 경상대학교 기계공학부 교수/항공기부품기술연구소, 교신저자(E-mail:choi@gnu.ac.kr)

** 경상대학교 항공우주시스템공학과 교수/항공기부품기술연구소

these defects by detecting the emitting strain energy when elastic waves are generated by the generation and growth of a crack, plastic deformation and fiber breakage, matrix cleavage or delamination[7-11].

In this paper, the AE signals of the filament wound composite cylinder and the sandwich cylinder during the pressure tests were measured and analyzed. The signal characteristics of PVDF sensors were measured, and an AE signal analyzer which had the low pass filter and resonance filter were designed and fabricated. Also, the crack detection capability of the fabricated AE signal analyzer was evaluated during the pressure tests of the filament wound composite cylinder and the sandwich cylinder.

2. Experiment and results

2.1 AE signal feature of the composite materials

The two step OP amp which could amplify the 200 times from the original PVDF sensor signals was fabricated. Fig. 1 shows the OP amp and Fig. 2 shows the PVDF sensor. The amplified signals were input to the computer using the A/D converter (NI USB 6251) and LABVIEW software. The FFT (Fast Fourier Transform) of the signal was done by AGU-Vallen Wavelet software.

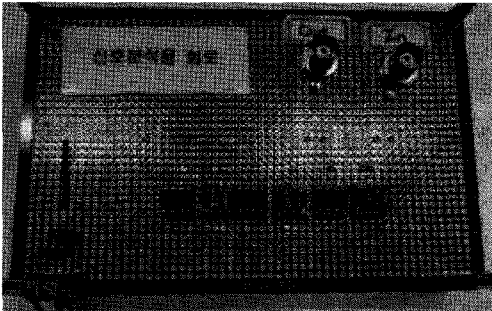

Fig. 1 Photograph of the OP amp.

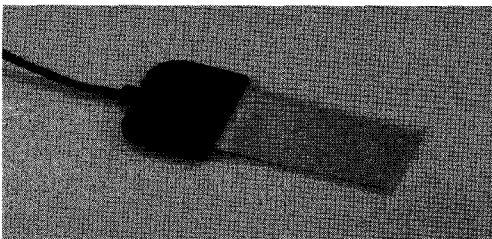

Fig. 2 Photograph of the PVDF sensor.

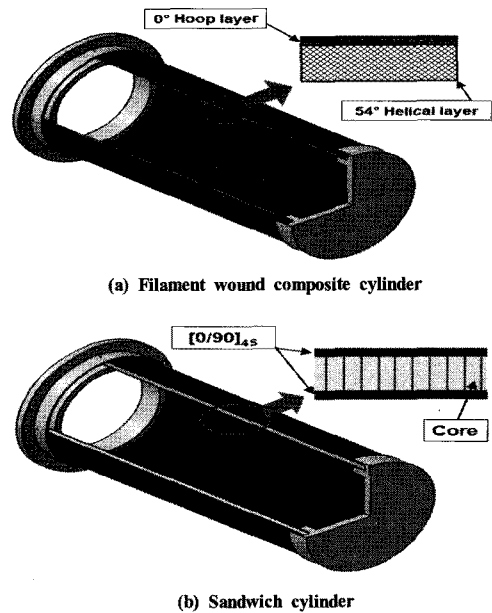
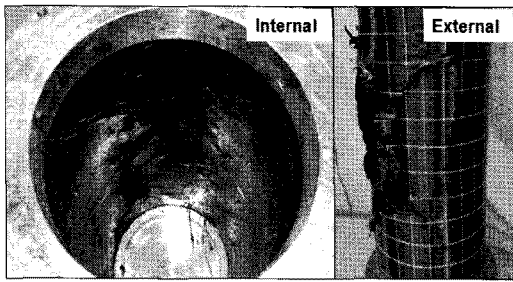

Fig. 3 Shapes of composite cylinder.

For the analyses of the composite fracture tests of the composite fracture signals, the external pressure tests of the composite cylinders were performed by the water pressure tester. Fig. 3 shows the schematic diagrams of the composite cylinders. The filament wound composite cylinder of Fig. 3 (a) was composed of the ± 54 layer and hoop layer, and the sandwich cylinder of Fig. 3 (b) was composed of two $[0/90]_{4s}$ laminates and honeycomb core. The prepreg for the composite laminate was USN-125B of the SK Chemical Co. Figure 4 shows the photograph of the fractured composite cylinder after the pressure test. Fig. 5 shows the FFT analyses of the AE signals around the fracture of the composite cylinder during the pressure test. As shown in Figure 5, the 240 - 330kHz frequencies were detected during the fracture. To measure the AE signals during the impact which do not occur the fracture, the impacts by a hammer were applied to the composite cylinder. Figure 6 shows the FFT signals during the impact. As shown in Figure 6, 0.1~ 1 kHz frequencies were detected during the impact test.

2.2 AE signal analyzer and fracture detection

The AE signal analyzer which can detect the fracture of the composite cylinder was designed and manufactured. Figure 8 shows the electric circuit of the AE signal analyzer. As shown in Figure 8, the amplified signal was input into the



(a) Filament wound composite cylinder

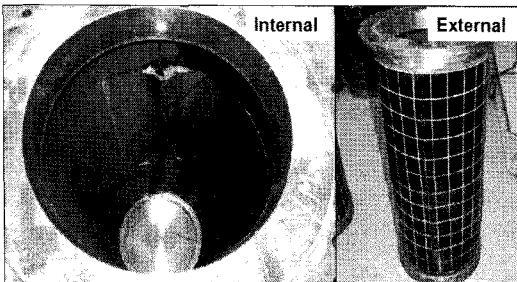

(b) Sandwich cylinder

Fig. 4 Photograph of the fractured composite cylinder after pressure test.

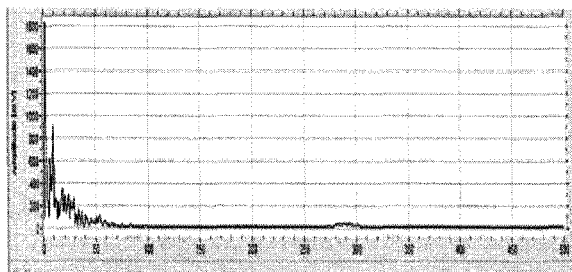
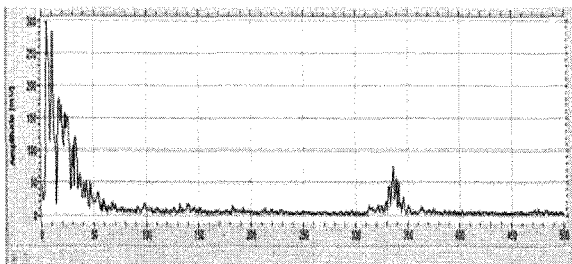

Fig. 5 FFT analyses of the AE signals under the pressure test.

low-pass filter and L-C resonator. The low-pass filter is for the impact detection and the L-C resonator is for the fracture detection. The cut-off frequency of the low-pass filter and the resonance frequency of the L-C resonator were

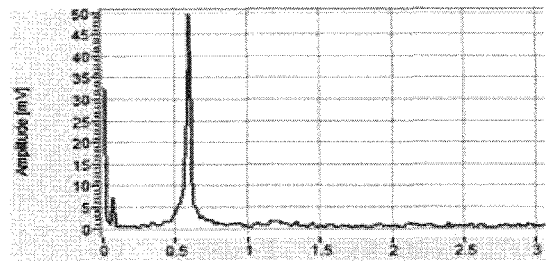
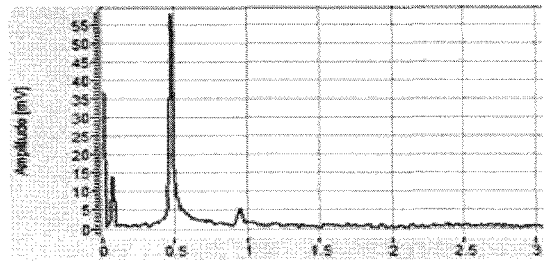

Fig. 6 FFT analyses of the AE signals under the impact test.

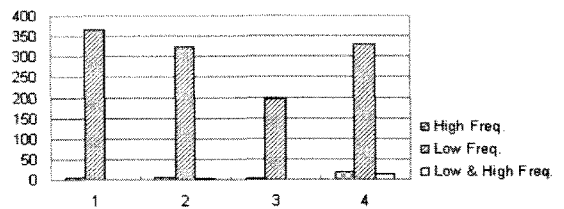
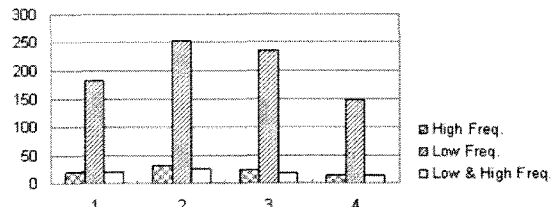

Fig. 7 Event counts after the impact test.

set to 700Hz and 240 Hz, respectively. Since the fracture frequencies of the composite cylinder can be changed slightly in each test and have a narrow band as shown in Figure 8, the band pass filter can be used. The filtered signals are input to the comparator. The digital signals of 5 volts are produced by the comparator when the filtered signals are larger than the threshold voltage level. the threshold level can be adjusted by the three counters. The each event count of low (impact) or high (fracture) frequency can be measured.

The impact tests of the composite cylinders were performed by an impact hammer. Figure 7 shows the event counts after the impact test. As shown in Figure 8, the low frequency event counts had a large value and they were about ten times of the high frequency (L-C resonator) event counts. For the generation of the composite fracture signals, the external pressure tests of the composite cylinders were performed by the water pressure tester. The water pressure was increased step by step with measuring the deformation shape of the composite cylinder. The buckling of the cylinder occurred

abruptly at the same time. Figure 9 shows the fracture detection of the composite cylinder using the L-C resonator. As shown in Figure 9, the high frequency event count had a larger value when the abrupt fracture of the composite cylinder occurred. The low frequency event count during the fracture had a small value relatively to the high frequency event count. Figure 10 shows the fracture detection of the composite cylinder using the band-pass filter. As shown in Figure 10, the high frequency event count had a larger value relatively to the low frequency event count during the fracture.

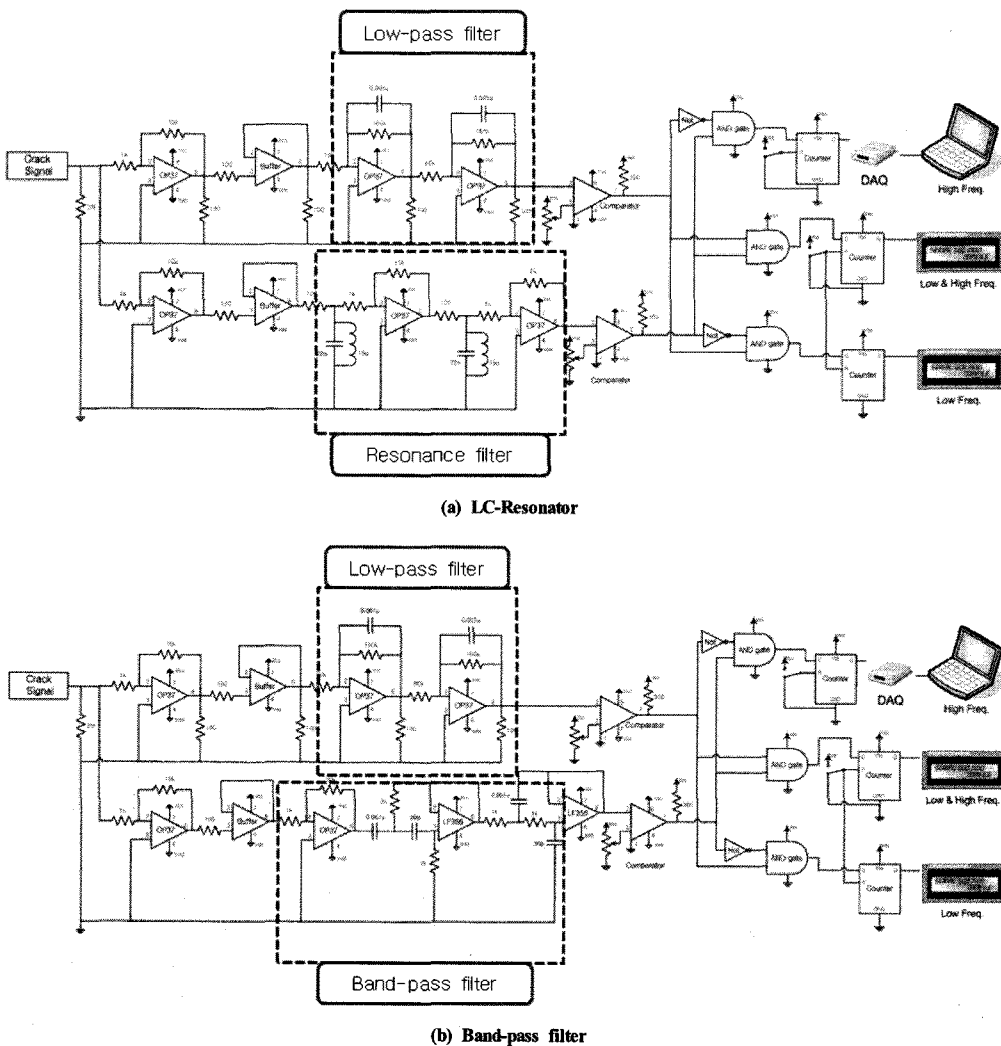
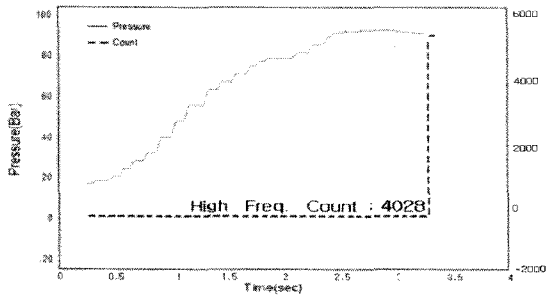
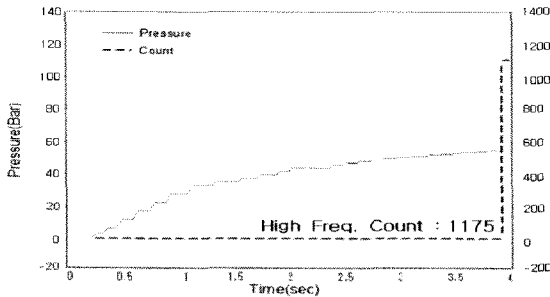

Fig. 8 AE signal analyzer.



(a) Filament wound composite cylinder



(b) sandwich cylinder

Fig. 9 Fracture detection of the composite cylinder using the fabricated AE signal analyzer (L-C resonator).

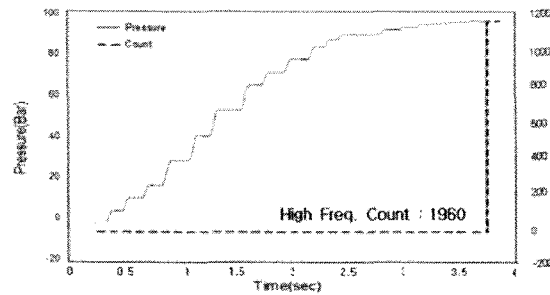

(a) Filament wound composite cylinder

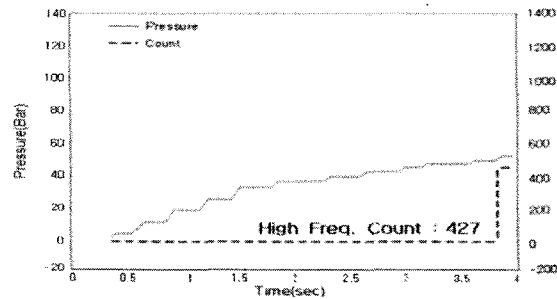

(b) sandwich cylinder

Fig. 10 Fracture detection of the composite cylinder using the fabricated AE signal analyzer (Band-pass filter).

From the impact and pressure tests, it could be proved the fabricated AE analyzer could distinguish and measure the mechanical impact and fracture of the composite cylinder under the pressure test.

3. Conclusions

In this paper, the AE signal analyzer to extract and counter the specified frequencies of the AE signals was designed and fabricated for the crack detection of the composite cylinder. For the extraction of the specified frequencies, L-C resonance filter and band pass filter were adopted. The mechanical impact and fracture of the composite cylinder under the pressure test could be distinguished and effectively measured by using the fabricated AE analyzer.

Acknowledgement

This work was supported by priority Research Centers program through the national Research Foundation of Korea (NRF) funded by the Ministry of Education, Science and Technology (2010-0029689) and the Degree and Research Center for Aerospace Green Technology(DRC) of the Korea Research Council of Fundamental Science & Technology (KRCF).

References

- 1) Reinhart J. J (Eds), Composite, SM International, Vol. 1, 1987 pp. 479-495
- 2) Masters J. E (Eds), Damage detection in composite materials, In, "Examination of selected NDF techniques for ceramic composite components"(Dunyak T. J, Stinchcomb W. W and Reifsnider), ATSM, STP 1128, 1992, pp. 3-24.
- 3) Masters J. E (Eds), 1992, Damage detection in composite materials, In "Application of X-ray tomography to the nondestructive testing of high-performance polymer composite", (Bathias C, Cagnasso A) ASTM, STP 1128 : pp. 35-54.
- 4) Masters J. E (Eds), Damage detection in composite materials, In "Defect classifications in composites using ultrasonic nondestructive evaluation techniques", (Steiner K. V), ASTM, STP 1128, 1992, pp. 72-84.

- 5) Chen J. Y, Hoa V, Jen C. K and Wang H. W, "fiber-optic and ultrasonic measurements for In-situ cure monitoring of graphite /epoxy composites," *Journal of Composite Materials*, Vol. 33, No. 20, 1999, pp. 1860-1881.
- 6) Takeda, Chen N. O and Kishi T. "Acoustic emission studies on fracture mechanisms of randomly Oriented carbon fiber reinforced glass matrix composite," *The 10th International Acoustic Emission Symposium*, 1990, pp. 394-400.
- 7) Yu Y. H, Choi J. H, Kweon J. W and Kim D. H, "A study on the failure detection of composite materials using an acoustic emission", *Journal of Composite Structures*, Vol. 75, 2006, pp. 163-169.
- 8) Asher R. C. 1997, "Ultrasonic sensors for chemical and process plant", Institute of physics publishing bristol and philadelphia, pp. 311-320.
- 9) 우성충, 최낙삼, "음향방출법을 이용한 편축노치를 갖는 유리 섬유/알루미늄 적층판의 파괴거동 해석," 한국복합재료학회지 Vol. 18, No. 2, 2005, pp. 1-12.
- 10) Narisawa I and Oba H., "An evaluation of acoustic emission from fiber-reinforced composites," *Journal of materials Science*, Vol. 19, 1984, pp. 1777-1786.
- 11) 이창훈, 최진호, 권진희, "Acoustic Emission(AE)을 이용한 복합재료 구조물의 비파괴 특성 연구," 한국복합재료학회 2004년도 춘계학술발표대회 논문집, 2004, Apr. 01, pp. 139-142.