

스마트/그린형 자동차의 위치정보시스템에 관한 연구

論 文
9-3-3

A Study on Vehicular Positioning Technologies for Smart/Green Cars

노갑성*, 오준석**, 리양동***

Kap-Seong Ro, Jun-Seok Oh, and Liang Dong

Abstract

Energy efficiency and safe mobility are the two key constituents of the future automobile. The technologies that enable these features are now heavily dependent upon information and communication technology rather than traditional auto-mechanical technology. This paper presents an exploratory project 'Smart&Green Vehicle Project' at Western Michigan University which is to improve the geographical location accuracy of vehicles and to study various applications of making such location data available. Global Positioning System (GPS), Inertial Navigation System (INS), Vehicular Ad-hoc Network (VANET) technology, and data fusion among these technologies are investigated. Testing and evaluation is done on systems which will gather vehicular positioning data during GPS signal loss. Vehicles in urban settings do not acquire accurate positioning data from GPS alone; therefore there is a need for exploration into technology that can assist GPS in urban settings. The goal of this project is to improve the accuracy of positioning data during a loss of GPS signal. Controlled experiments are performed to gather data which aided in assessing the feasibility of these technologies for use in vehicular platforms.

Keywords : Global Positioning System (GPS), Inertial Navigation System (INS), Vehicular Ad-hoc Network (VANET), Urban canyon

I. Introduction

The United States has invested heavily (approximately \$125 billion) in the Highway Transportation System as enacted by the Federal-Aid Highway Act of 1944 and financed by the Federal-Aid Highway Act of 1956 supported by Dwight Eisenhower [1]. As a result

of these roadway systems being available for public use, rapid suburbanization (workers moving to suburbs and working in urban areas) developed. Economic benefits were also enjoyed as materials could be moved more rapidly from one point to another without having to be routed through public transportation systems. With all this taken into consideration, for those economic benefits to continue "survival of modern economies is predicated on the energy efficient and reliable supply chains." Two avenues to 'go green' are to increase the efficiency of the vehicle that travel on the roadways and the roadway system itself. The vehicle safety is also a primary contributing factor.

The Smart&Green Vehicle project carried out

접수일자 : 2010년 07월 21일

최종완료 : 2010년 09월 10일

*Department of Mechanical & Aeronautical Engineering, Western Michigan University

교신저자, E-mail : kapseong.ro@wmich.edu

**Department of Civil & Construction Engineering, Western Michigan University

***Department of Electrical and Computer Engineering, Western Michigan University

at Western Michigan University (WMU) addresses increasing the efficiency of the roadway system by evaluating potential systems to increase vehicular positioning accuracy and potential benefits of such data.

GPS has been widely applied for identifying vehicle positions since the mid 90's. However, large positioning errors (see Fig. 1) may occur particularly when the system is used in urban canyon environments, (i.e. large metropolitan areas) where tall buildings or natural topography occlude satellite signals [2]. Improving positioning precision regardless of geographical location should be sought as it is a critical factor for the future Smart/Green automobile.

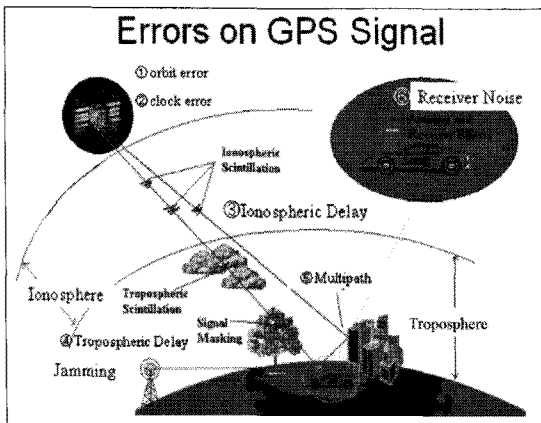

Fig. 1. GPS errors

II. Controlled Experiment & Simulation

1. Development File

To begin any scientific evaluation a controlled environment has to be established, which is a benchmark for all hypotheses to be evaluated against. Given the nature of transportation, a roadway system is required that is relatively ease of access and information gathering. This site also had to be able to simulate the 'urban canyon' in which there is loss of GPS signal. The controlled environment was chosen as roadways near Parkview Campus at Western Michigan University

(WMU) as shown in Fig. 2 and was calibrated against known measurement techniques to quantify all evaluations to establish the control file in AutoCAD.

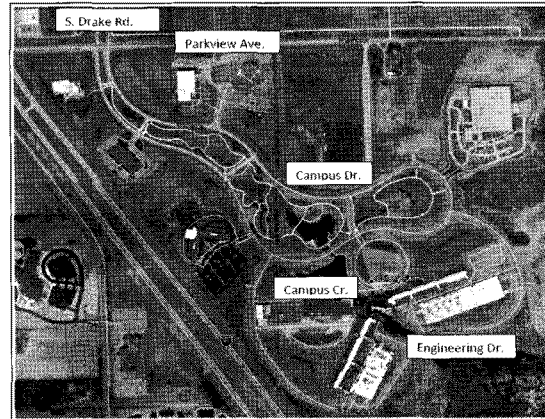

Fig. 2 Aerial photo of WMU parkview campus

2. Coordinate File

Universal Transverse Mercator (UTM) coordinate system, having coordinates of (easting, northing, elevation) was chosen as it is based on the Cartesian coordinate system with coordinates of (x, y, z) . This made establishing the control file in AutoCAD simple as AutoCAD is based on a Cartesian system. UTM coordinate system is simply a conversion of projecting the ellipsoidal earth surface (non-planar) onto a flat map (planar). This is accomplished by dividing the World's surface up into zones (see Fig. 3).

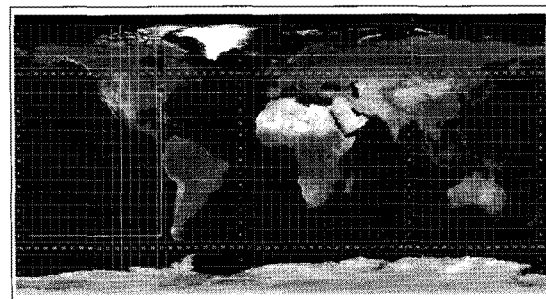

Fig. 3 UTM coordinate system

By drawing the zone in which the test site is located, and all adjacent zones, a base grid of the control file was established as shown in Fig. 4, with the test site at the arrow's point. Where the outline of Campus Drive, also in

Fig. 4, was placed into the grid system based on two control points. The drawing for Campus Drive was provided by WMU facilities.

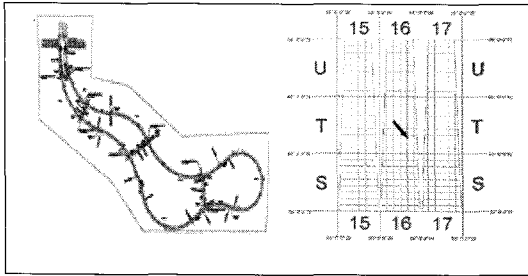

Fig. 4 UTM grid in control file

3. Control Points

A handheld GPS unit integrated with a geographical information systems (GIS) is used for this study. The position accuracy of the unit is within 1.5m to 2.0m (4.9ft to 6.6ft). Given that a design passenger vehicle (7ft wide) and smallest recommended lane width (9ft) by the American Association of State Highway and Transportation Officials (AASHTO), accuracies of the handheld GPS system were unacceptable to establish a control file. As a result, (6 sets) of (3 points per set) were collected on two curves, on opposite ends, of Campus Drive. Three points per set was chosen because a curve can be completely defined based on three points on its circumference which was able to be readily measured by the handheld GPS. By considering all possible combinations of the total (18 points), (216 center-points) were able to be established. The center-points were able to be calculated based on the definition of a circle and the Pythagorean Theorem as they relate to Fig. 5. Resultant coordinate equations of the center-points are given below.

$$x_c = \frac{\frac{y_2^2 - y_3^2 + x_2^2 - x_3^2}{2(x_2 - x_1)} + \frac{x_2^2 - x_1^2 + y_2^2 - y_1^2}{2(y_2 - y_1)} \left(\frac{y_3 - y_2}{x_2 - x_3} \right)}{1 - \frac{(x_1 - x_2)(y_3 - y_2)}{(y_2 - y_1)(x_2 - x_3)}} \quad (1)$$

$$y_c = \frac{x_1^2 - x_2^2 - 2x_c(x_1 - x_2) - y_2^2 + y_1^2}{(-1)(2)(y_2 - y_1)}$$

By completing statistical analysis [4] on the (216 center-points) with discarding possible outliers, a 99% confidence interval was able to be established in which the control points have an accuracy of approximately (± 2 inches). This is not survey grade (± 0.5 in); however, it has been deemed acceptable for this project's control file.

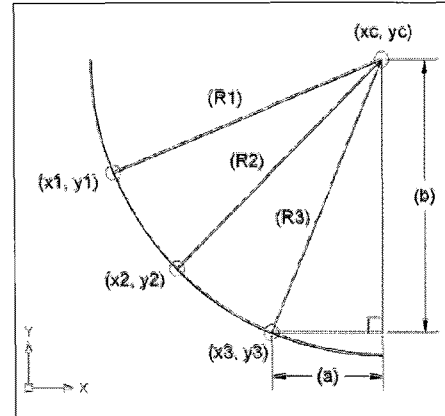

Fig. 5 3-point circle

Setting the drawing in the grid system based on these two control points (center-points of curves) the AutoCAD control file was able to be established to with an accuracy of approximately (± 2 inches).

4. Simulation

With the control file established a simulation file based on Quadstones's Paramics Modeler software was constructed. A screen shot of the model is shown in Figure 6.

This simulation file is based on the control

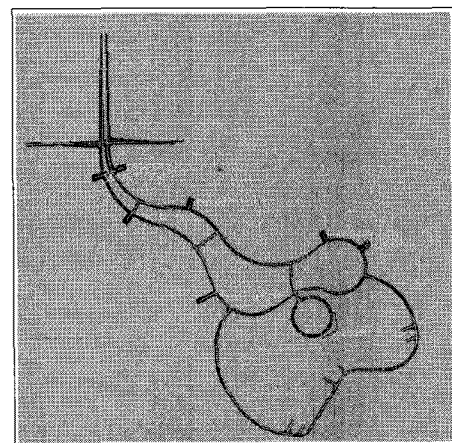

Fig. 6 PARAMICS simulation file

file so that the vehicular positioning output data will correlate to the collected physical data from vehicle testing on the selected site. On the physical test site it is not feasible to test more than one or two vehicles at once due to budget constraints. However, by determining the characteristics (tolerance, data collection rate, and processing rate) of a system, a community of multiple vehicles with these characteristics can be evaluated.

It is noted that no coordinate system had been established to relate radio wave ranging system through Vehicular Ad-hoc Network (VANET) to coordinates at that time in the project. Associated vehicular tolerance and minimum data collection rate also need to be evaluated. These topics are expanded shortly.

5. Recommended Vehicle Lane Tolerance

Two main forms of vehicular tolerance are associated with the vehicle kinematics; one tolerance being the forward and aft associated with acceleration and braking parallel to the line of action of the vehicle. Second tolerance being that of lateral tolerance associated with the vehicle's width in relation to the lane width.

However, when considering a vehicle's lateral tolerance, with respect to common roadway widths, the tolerance is much less forgiving. A typical design passenger vehicle as used in the American Association of State Highway and Transportation Official's (AASHTO's) Geometric Design of Highways and Streets [5] is (7 ft) wide. This text also recommends that the smallest roadway width be (9 ft). Assuming these dimensions are the "worst case scenario," the lateral tolerance of a vehicle was determined as $(9ft - 7ft)/2ft = 1ft$. Applying a factor of safety of 2, the final tolerance of ± 6 inches is established which is reasonable based on a standard vehicle design and associated roadway width.

6. Recommended Data Acquisition Rate

The extreme case to be analyzed for the data collection rate at which the tolerance stated is to be maintained is limited by a vehicle's physical capacity to accelerate laterally (turn). The upper limit of this acceleration is generally under $a_n = 1g = 32.174ft/s^2$. This equates to a center seeking force (centripetal) equal to that of the vehicle's weight, which is normally only exerted in the vertical direction toward the center of the earth. The tangential speed v_t of a vehicle is dependent on the lateral acceleration a_n and radius r , as defined in

$$r = \frac{v_t^2}{a_n} \quad (2)$$

Associated terms are shown in Figure 7.

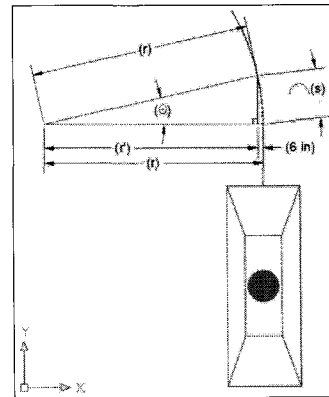

Fig. 7 Radial acceleration diagram

Collection rate is also dependent on time (t) which relates to speed v_t and distance covered s as defined in basic kinematics as

$$v = \frac{s}{t} \quad (3)$$

The distance traveled s is defined as $s = r\theta$. The function for data collection frequency as it relate to lateral tolerance is

$$frequency(Hz) = \frac{a_n}{1.4667v_t \cos^{-1}\left(\frac{r'}{r}\right)} \quad (4)$$

Plotting this function, it can be seen that for a lateral change in the vehicle's position at speeds ranging from approximately (18 mph) to (75 mph) with an 1g lateral acceleration, the

collection rate ranges from (5.66 Hz) at (18 mph) to (5.67 Hz) at (75 mph). Thus, it is able to be conclude that the recommended data collection rate to maintain positioning data in accordance with the (± 6 inch) tolerance is (6 Hz) = (6 cycles/second).

III. Inertial Navigation System

One approach to resolving the issue of intermittent GPS positioning information is the integration of INS systems with the GPS module. A Strapdown-INS (SDINS) consists of a set of three accelerometers and three angular rate-gyros, so called an inertial measurement unit (IMU), which are mounted in orthogonal configuration on a moving vehicle in inertial space. An onboard computer uses these measurements to perform coordinate transformation and numerical integration of Newton-Euler equations in real-time, and calculates the inertial orientation (roll, pitch, yaw) angles and the inertial location relative to a known starting point. However, the gyros and accelerometers are noisy sensors and the measurements are drifting with time. Thus, the accuracy depends on sensor grade and the technology is not ready yet for general public use for extremely high sensor cost.

Integrating an INS with GPS has been studied and is mature enough for practical applications to enhance vehicle safety, precision navigations, etc. Conversely, a purely GPS based navigation system performance can be enhanced by combining it with IMU, which is especially useful for urban canyon environment. Recently, there have been significant advancements in micro-electro-mechanical sensors (MEMS) technology which allowed manufacturing a small and low cost inertial and the earth magnetic field detection sensors, yet producing reasonable accuracy in dynamic environment. Table 1

shows typical performance and accuracy characteristics in terms of INS grade.

Table 1. INS sensor grade & accuracy

	High (>\$750,000)	Medium (~\$100,000)	Low (<\$10,000)
Position			
1 hour	0.3-0.5 km	1-3 km	200-300km
1 minute	0.3-0.5 m	0.5-3 m	30-50 m
1 second	0.01-0.02 m	0.03-0.1 m	0.3-0.5 m
Attitude			
1 hour	3-8 mdeg	0.01-0.05 deg	1-3 deg
1 minute	0.3-0.5 mdeg	4-5 mdeg	0.2-0.3 deg
1 second	<0.3 mdeg	0.3-0.5 mdeg	0.01-0.03 deg

1. Strap-down INS Principle

The basic principle of a strap-down inertial navigation system (SDINS), illustrated in Fig. 8, is numerically integrating accelerometer signals twice using an on-board computer to get inertial position (INS), and angular rate signals once to get inertial orientation angles with necessary coordinate transformation in the process (Attitude-Heading-Reference-System, AHRS).

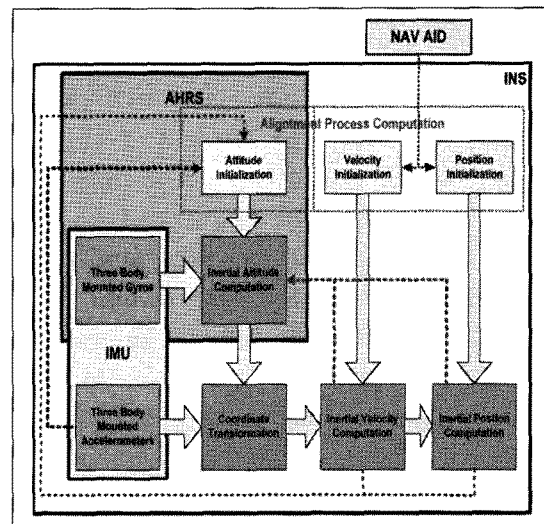

Fig. 8 Strapdown INS principle

This means that inherent noise and biases in the sensors lead to unbounded, exponential error growth in time through the integration process. By coupling with external navigational aid sensors such as GPS, LORAN (in aviation), a tri-axial fluxgate magnetometer (the earth magnetic field detection sensor) and employing a

statistical estimation technique (Extended Kalman Filter), reasonable accuracy can be obtained even with a low-cost MEMS based sensors which is adequate for a short-term navigation. This would greatly enhance a simple GPS based navigation system when GPS signals are poor or intermittently available without adding heavy additional cost of IMU sensors.

2. Test & Evaluation

In this study, Crossbow NAV440 (Fig. 9) is used for position calculation during GPS signal [3]. It is regarded a low cost and low-grade MEMS based IMU sensors; its costs may be brought down to an affordable range for automotive application when only considered sensor unit cost. NAV440 is an AHRS unit with GPS. It also includes a fluxgate magnetometer, and is equipped with an onboard microprocessor and uses Extended Kalman Filter (EKF) to calculate inertial orientation angle of a platform on which it is mounted. Only GPS position is available, thus no position data is available with GPS function disabled.

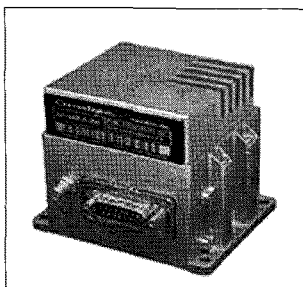

Fig. 9 Crossbow NAV440

A direct integration method based on Runge-Kutta 4th order method is used for off-line simulation analysis to obtain inertial position information using the readings from the IMU sensors (100Hz update rate), and then compared with the GPS reading (1Hz update rate). To understand the performance of IMU based inertial position calculation, GPS position data is used at each 5 seconds to reset the initial condition for the integration process.

Fig. 10 shows the test track representing the

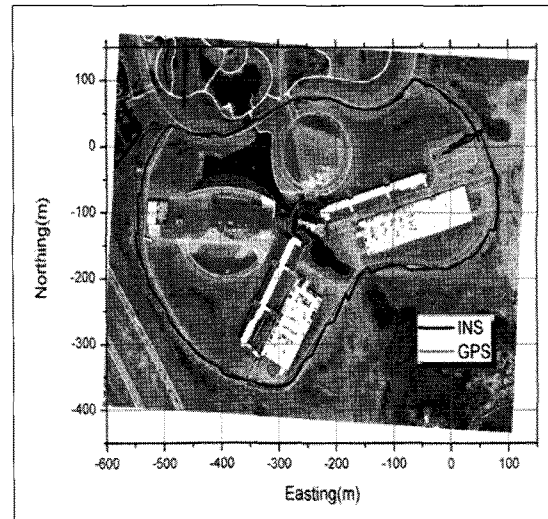

Fig. 10 Strapdown INS principle

driving distance of 1800 meter for 200 seconds. Prior to starting, the initial conditions including orientation angle, position and velocity are measured using GPS and NAV 440. Red line shows the trajectory of the vehicle inertial position based on GPS, while black line is calculated INS trajectory with assisted GPS at every 5 seconds. Looking at the INS trajectory, some saw tooth shape errors are apparent from the integration process.

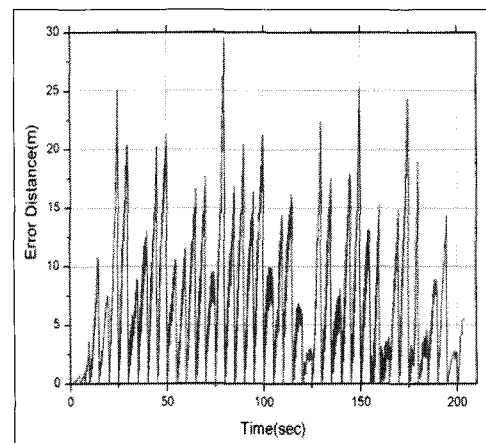

Fig. 11 Distance error

Fig. 11 shows the difference in distance between GPS and INS trajectory. Maximum error is below 30 meters. The difference can be somewhat substantial, but it can be improved with an EKF in the velocity-position calculation process, or by coupling with Geographic Information System (GIS) that is used in the

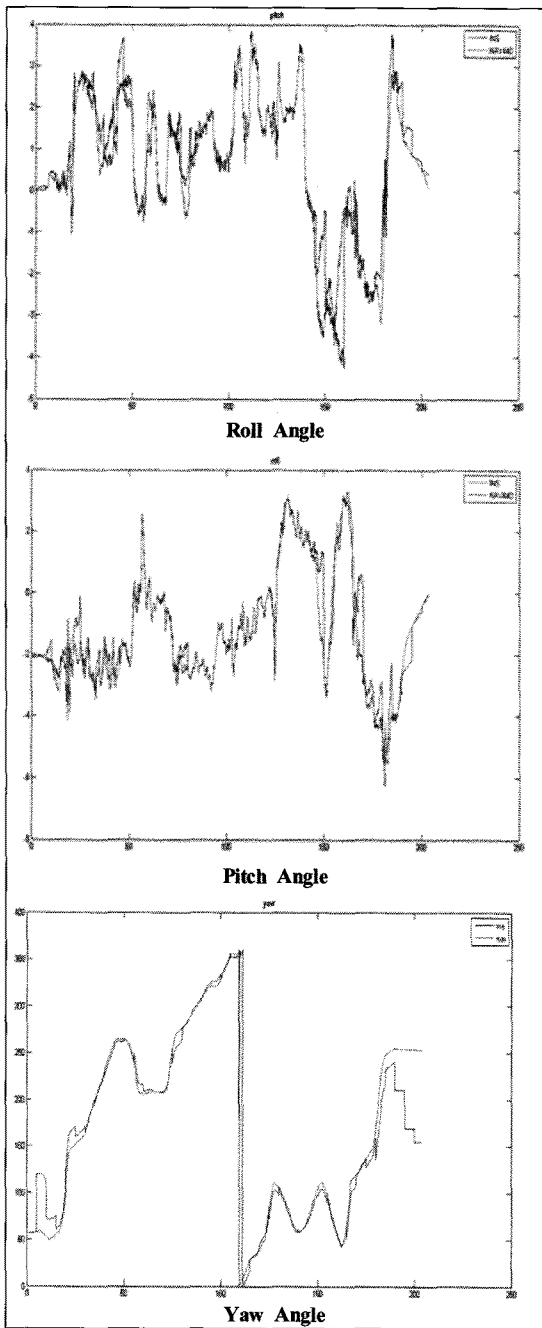

Fig. 12 Attitude angles

current GPS navigation system [6].

Figure 12 shows the inertial orientation angles (Roll, Pitch, Yaw) based on numerical integration based on the rate gyro signals, which are compared with NAV-440's value that uses an EKF. The error in the roll and pitch angle remains within 1 degree, while yaw angle is under 5 degree difference. Yaw angle difference is relatively large even at a stationary situation because GPS heading has a

large error at no motion. This error can be improved by employing a stationary yaw locking algorithms, a fluxgate magnetometer, or dual GPS sensors.

IV. Radio-wave Distance Ranging

1. Trilateration using VANET

An alternative method to resolve GPS signal loss in urban canyon situation is to make use of Vehicular Ad-hoc Network (VANET) concept; a mobile network created by every moving cars within 100 to 300 meters where each car is acting as a node [7]. If a car falls out of the signal range and drop out of the network, another cars can join in, connecting vehicles to one other thereby a mobile internet is created. Two types of network formation can be considered; Vehicle-to-vehicle (V2V) and Vehicle-to-Roadside Infrastructure (V2I) communication. In this study, compensating GPS signal loss using the radio wave signal strength is considered for a relative distance calculation in V2I environment. Two control point towers, as shown in Fig. 13, has been established, which is advantageous for the controlled experimental study.

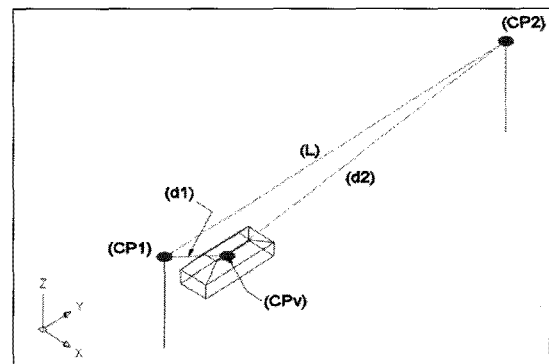

Fig. 13 Trilateration based on Radio-wave in VANET

Through basic trigonometric relations (Trilateration) the following functions have been derived that can be applied to the (easting, northing, elevation) coordinate points to determine the vehicular UTM coordinates.

$$\text{Northing: } s = \frac{d_2^2 - L^2 - d_1^2}{(-2)L}$$

$$\begin{aligned} \text{Elevation: } H_r + H_y > H_t &\Rightarrow H = H_y + H_r - H_t \\ H_r + H_y < H_t &\Rightarrow H = H_y - H_r - H_t \end{aligned}$$

$$\text{Easting: } d_1 = \sqrt{\left[d_1^* \sin \left\{ \cos^{-1} \left(\frac{d_2^2 - L^2 - d_1^2}{-2Ld_1} \right) \right\} \right]^2 - H^2}$$

Using the laws of cosine, the lane tolerance equations as discussed earlier associated with each direction can also be determined as following:

$$\pm \Delta_x = \left| \frac{\pm \Delta_{x1}}{\pm \Delta_{d1}} \right| (\pm \Delta_{d1}) + \left| \frac{\pm \Delta_{x2}}{\pm \Delta_{d2}} \right| (\pm \Delta_{d2}) \quad (5)$$

where,

$$\begin{aligned} \left| \frac{\pm \Delta_{x1}}{\pm \Delta_{d1}} \right| &= \sqrt{\sin \left[\cos^{-1} \left\{ \frac{b^2 - 1 - a^2}{(-2)a} \right\} \right]^2 - \frac{c^2}{a^2}} \\ \left| \frac{\pm \Delta_{x2}}{\pm \Delta_{d2}} \right| &= \sqrt{\sin \left[\cos^{-1} \left\{ \frac{a^2 - 1 - b^2}{(-2)b} \right\} \right]^2 - \frac{c^2}{b^2}} \end{aligned}$$

$$\pm \Delta_y = \left| \frac{\pm \Delta_{y1}}{\pm \Delta_{d1}} \right| (\pm \Delta_{d1}) + \left| \frac{\pm \Delta_{y2}}{\pm \Delta_{d2}} \right| (\pm \Delta_{d2}) \quad (6)$$

where,

$$\begin{aligned} \frac{\pm \Delta_{y1}}{\pm \Delta_{d1}} &= \frac{b^2 - 1 - a^2}{(-2)a} \\ \frac{\pm \Delta_{y2}}{\pm \Delta_{d2}} &= \frac{a^2 - 1 - b^2}{(-2)b} \end{aligned}$$

$$\pm \Delta_z = (\pm \Delta_{Ht}) + (\pm \Delta_{Hr}) + (\pm \Delta_{Hy}) \quad (7)$$

Here,

$$a = \frac{d_1}{L}, \quad b = \frac{d_2}{L}, \quad c = \frac{H}{L}$$

Term $\left| \frac{\pm \Delta_{x1}}{\pm \Delta_{d1}} \right|$ has been evaluated explicitly

as charted in Fig. 14. This information will prove valuable as the analysis of such a system progresses since it relates vehicular tolerance to a specified tower, vehicle relational geometry. The two terms that still need to be defined finitely are those tolerance functions $\pm \Delta_{d1}, \pm \Delta_{d2}$ which are the tolerances in radio wave ranging systems legs d_1 and d_2 as shown in Fig. 13. These terms are system dependent and are to be determined based on the radio signal data analysis and associated functions

that relate to how tolerance is dependent on determined parameters. (distance, atmosphere, physical obstructions, etc.)

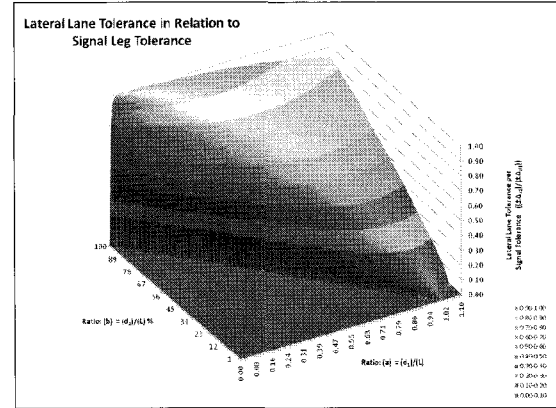

Fig. 14 Lateral lane tolerance

2. Test & Evaluation

In this study, a controlled V2I environment previously described is created to study the distance ranging methods using radio wave signal. Most of the currently available transceivers have Received Signal Strength Indicator (RSSI), which is the measurement of power present in a received radio signal. The distance from RSSI can be determined by the Free Space Path Loss (*FSPL*) equations as follows:

$$FSPL = \left(\frac{4\pi d}{\lambda} \right)^2 = \left(\frac{4\pi f}{c} \right)^2 \quad (8)$$

where λ is the signal wavelength in meters, f is the signal frequency in hertz, d is the distance from the transmitter, and c is the speed of light in vacuum. It is to be noted that this equation holds true for only far field [8]. To test the feasibility of RSSI ranging measurement concept, a 2.4 GHz wireless router and a laptop computer with a wireless modem were tested. Fig. 15 shows the RSSI vs. Separation Distance.

Next a set of three prototype ranging devices are fabricated of which each module is equipped with a GPS receiver, and a microprocessor, and a 2.4 GHz transceiver. The calculation for converting GPS coordinates to UTM coordinates as described earlier was done in realtime on-board. Total 4 test trials were

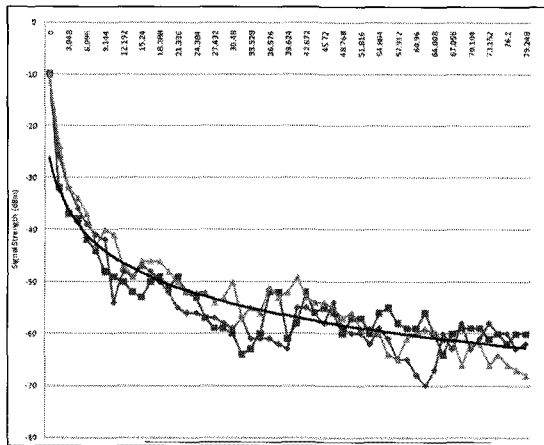

Fig. 15 RSSI vs. Separation distance

Table 2. RSSI based Distance Test

	Test Site 1		Test Site 2	
	Trial 1	Trial 2	Trial 1	Trial 2
Latitude 1	0.737443	0.737443	0.737449	0.737449
Longitude 1	-1.49472	-1.49472	-1.49472	-1.49472
Northing 1	4678690	4678689	4678732	4678730
Easting 1	612076.2	612076.8	612099.5	612099.5
Latitude 2	0.737448	0.737448	0.737455	0.737455
Longitude 2	-1.49472	-1.49472	-1.49472	-1.49472
Northing 2	4678723	4678725	4678769	4678768
Easting 2	612093.3	612093.3	612113.3	612114
Unknown Northing	4678694	4678696	4678741	4678740
Unknown Easting	612109.1	612109.2	612131.3	612131
L	37.15008	39.57514	39.51602	41.14

performed; two different trials at two different locations. Table 2 shows the test results.

From the test results shown in Table 2, it can be concluded that CP1 and CP2 (control point towers in Fig. 13) are in the correct position corresponding to their geographical locations, and the calculated unknown points are approximately in the vehicle location.

VI. Conclusion

GPS is a very inexpensive yet giving reasonably accurate navigation system. However, it often encounters signal loss and performance degradation especially in urban driving and oth-

er natural features. Coupling it with INS system and/or integrating it with VANET concept may overcome these disadvantages, and thus became a feasible option as the low cost sensors are now available with an advent of MEMS technology along with high-performance network communications hardware. This study conceived a robust vehicular positioning technology for the future automobile with these technologies. This combination of technology will enable more accurate positioning data to be collected, and will lead to safer, smarter and greener vehicles.

Acknowledgements

This work was supported by DENSO North America. The authors thank senior engineering students, Mr. Jacob Dieter and Mr. Chad Albert, who carried out various road experiments for this study.

[References]

- [1] *A policy on geometric design of highways and streets*, American Association of State Highway and Transportation Officials (AASHTO), Washington, DC, 1984.
- [2] Y. Cui and S. S. Ge, "Autonomous vehicle positioning with GPS in urban canyon environments," in *IEEE Transactions on Robotics and Automation*, vol. 19, no.1, pp. 15-25, Feb. 2003.
- [3] *Crossbow NAV440 Series Inertial Systems User's Manual*. Crossbow Technology, Inc., San Jose, CA. 2007.
- [4] D. M. Levine, R. R. Ramsey, and R. K. Smidt, *Applied Statistics: for Engineers and Scientists*, New Jersey, Prentice Hall, 2001.
- [5] F. L. Mannering, W. P. Kilareski, and S. S. Kilareski, *Principles of Highway Engineering and Traffic Analysis, 4th ed.*, Wiley & Sons. New Jersey, 2009.
- [6] G. Taylor and G. Blewitt, *Intelligent Positioning: GIS-GPS Unification*, John Wiley & Sons, New Jersey, 2009.
- [7] S. Eichler, C. Schroth, and J. Eberspächer, "Car-to-Car Communication," *Institute of*

Communication Networks, Technische Universitat Munchen, Munchen, Germany. VDE-Kongress - Innovations for Europe (Aachen). 2006.

[8] X. Zhao, J. Kivinen, P. Vainikainen, and K. Skog.,

"Propagation characteristics for wideband outdoor mobile communications at 5.3 GHz," in *IEEE Journal on Selected Areas in Communications*, vol. 20, no. 3, pp. 507-514, 2002.

Biography



Kap-seong Ro

1986 B.S., Mechanical Engineering, Drexel University
1988 M.S., Mechanical Engineering, Drexel University
1995 Ph.D., Aerospace Engineering, University of Maryland at College Park

2003 ~ Current Associate Professor, Western Michigan University

<Interest> Robust & Optimal Control, Flight & Ground Vehicle Dynamics, Guidance & Navigation

<e-mail> kapseong.ro@wmich.edu

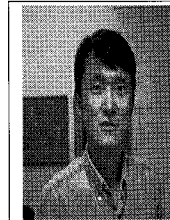

Jun-Seok Oh

1984 B.S. Urban Engineering, Hanyang University
1993 M.S., Transportation Engineering, Hanyang University
2001 Ph.D., Civil Engineering, University of California, Irvine

2003 ~ Current Associate Professor, Western Michigan University

<Interest> Transportation network analysis, dynamic traffic management, Intelligent Transportation System

<e-mail> jun.oh@wmich.edu



Liang Dong

1996 B.S. Applied Physics, Shanghai Jiao Tong University
1998 M.S., Electrical & Computer Engineering, University of Texas at Austin
2002 Ph.D., Electrical & Computer Engineering, University of Texas at Austin

2004 ~ Current Associate Professor, Western Michigan University

<Interest> Communication Systems, Wireless Networks, Digital Signal Processing, Real-time Embedded System

<e-mail> liang.dong@wmich.edu