

Novel Equalization On-Channel Repeater with Feedback Interference Canceller in Terrestrial Digital Multimedia Broadcasting System

Sung Ik Park, Homin Eum, So Ra Park, Geon Kim, Yong-Tae Lee, Heung Mook Kim, and Wangrok Oh

In this paper, we propose a novel equalization on-channel repeater (OCR) with a feedback interference canceller (FIC) to relay terrestrial digital multimedia broadcasting signals in single frequency networks. The proposed OCR not only has high output power by cancelling the feedback signals caused by insufficient antenna isolation through the FIC, but also shows better output signal quality than the conventional OCR by removing multipath signals existing between the main transmitter and the OCR through an equalizer. In addition, computer simulations and laboratory test results demonstrate that the proposed OCR successfully cancels feedback signals and compensates channel distortions and provides a higher quality transmitting signal with higher output power than conventional OCRs.

Keywords: T-DMB, single frequency network (SFN), on-channel repeater (OCR), equalizer, feedback interference canceller (FIC).

I. Introduction

In the terrestrial-digital multimedia broadcasting (T-DMB) system, a mobile broadcasting standard in South Korea based on the Eureka-147 digital audio broadcasting (DAB) system [1], orthogonal frequency-division multiplexing (OFDM) has been adopted for signal transmission [2], [3]. T-DMB focuses on the broadcasting of moving pictures and their reception in harsh conditions, such as places surrounded by high-rise buildings and highways where vehicles are moving at very high speeds [4]. In particular, for stable reception of T-DMB in mobile conditions, the design of a single frequency network (SFN) is required as well as maintenance of a certain level of channel power.

In general broadcasting systems, SFNs can be implemented using a number of transmitters that operate at the same frequency through a global positioning system (GPS), and using on-channel repeaters (OCRs) that use the same frequency as transmitters [5]-[9]. In T-DMB networks, while the transmitters can transmit a high-quality signal with high power, the distance between the transmitters is restricted by the length of the guard interval of the OFDM system, and the cost for their setup and maintenance is relatively high. In the case of OCRs, their installation and maintenance can be done efficiently; however, the transmission power is limited by feedback signals due to insufficient antenna isolation, and the quality of a transmitted signal is not reliable. Complementary to existing OCRs, the equalization OCR (E-OCR) has been proposed [10]. The E-OCR provides a high-quality

Manuscript received Jan. 9, 2009; revised Apr. 27, 2009; accepted May 4, 2009.

This work was supported by the IT R&D program of MKE/ITA, Rep. of Korea (2009-S-015, Development of Transmission Enhancement Technology for Terrestrial DTV System).

Sung Ik Park (phone: +82 42 860 6648, email: psi76@etri.re.kr), Homin Eum (email: hmeum@etri.re.kr), So Ra Park (email: parksora@etri.re.kr), Geon Kim (email: kimgoon@etri.re.kr), Yong-Tae Lee (email: yilee@etri.re.kr), and Heung Mook Kim (email: hmkim@etri.re.kr) are with Broadcasting & Telecommunications Convergence Research Laboratory, ETRI, Daejeon, Rep. of Korea.

Wangrok Oh (email: kingrock@cnu.ac.kr) is with Division of Electrical and Computer Engineering, Chungnam National University, Daejeon, Rep. of Korea.

doi:10.4218/etrij.09.0109.0009

transmission signal with high power because of the rejection capability of feedback signals caused by insufficient antenna isolation and multipath signals existing between the main transmitter and the OCR. However, when the electric field strength of feedback signals is higher than that of the input signal transmitted from the main transmitter, the equalizer in the E-OCR cannot remove the feedback signals, thereby causing an E-OCR malfunction. Due to the limited rejection capability of feedback signals, the E-OCR is not ideal for use in a typical repeating facility and requires a great deal of investment.

To improve the rejection capability of feedback signals in the conventional E-OCR, this paper proposes a configuration and implementation method of an E-OCR with a feedback interference canceller (FIC). In addition, the proposed E-OCR is analyzed through computer simulations, and is verified by laboratory testing.

II. OCR for T-DMB System

1. Requirements of OCRs

The OCRs for the T-DMB system shown in Fig. 1 are used to fill in gaps and to extend service areas that transmitters cannot cover. Well-designed OCRs should meet the following requirements [10]-[12].

- OCRs should maintain frequency synchronization between the receiving and transmitting signals. Any divergence in frequency will cause Doppler shifts. Such Doppler shifts place additional burden on the receivers.
- OCRs should remove feedback signals caused by low isolation between transmitting and receiving antennas. If there is not enough antenna isolation, the feedback signals from the transmitting antenna may interfere with a received signal. Such feedback signals can degrade the quality of the received signal and result in an oscillation of the power amplifier in the OCRs. Therefore, the output power of the OCRs depends on antenna isolation.
- OCRs should have a high-quality transmitting signal. Although the received signal is distorted by multipath signals between the main transmitter and repeater, the OCRs have to be able to effectively recover the distortion of the received signal. If such distortion is not removed properly, the re-transmitting signal still remains to be distorted, resulting in a coverage reduction.
- The processing delay of the OCRs should be as short as possible. If the processing delay of the OCRs is longer than the guard interval, it causes a pre-ghost with a long time delay, resulting in performance degradation of the receiver. The maximum permitted processing delay of OCRs for a T-DMB

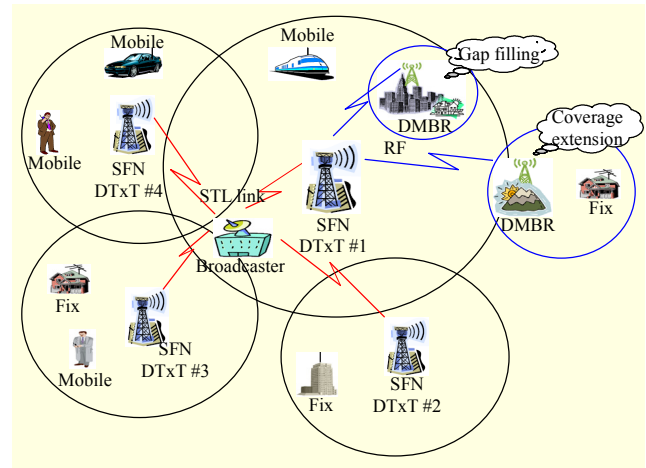

Fig. 1. SFN configuration for a T-DMB system.

system is generally three-tenths of the guard interval, that is, about 74 μ s.

2. Conventional OCRs

Conventional OCRs for a T-DMB system are shown in Fig. 2 and are classified into analog types that include radio frequency (RF) and intermediate frequency (IF) processing OCRs, and digital types that include an OCR with FIC and an OCR with an equalizer.

The RF processing OCR shown in Fig. 2(a) maintains constant synchronization between receiving and transmitting signals, and its processing delays are shorter than those of other OCRs (0.5 to 1 μ s). However, because of insufficient isolation between receiving and transmitting antennas, which cannot remove feedback signals, an RF OCR should transmit a low-power signal. The quality of the transmitting signal is also low since it does not have the capability of multipath rejection.

Figure 2(b) shows an IF processing OCR, which has a relatively short processing delay (1 to 2 μ s) due to its simple structure. The band-pass filter (BPF) selectivity of the IF processing OCR is superior to that of the RF processing OCR, but its other characteristics are not reliable.

Figure 2(c) shows a digital type OCR which includes an FIC. The OCR with an FIC can transmit a high-power signal due to the feedback signal rejection capability, and its transmitting signal quality is better than that of the analog type OCRs [13]. However, it has a relatively long processing delay compared to analogue type OCRs, and it still cannot remove multipath signals, although the feedback signals can be rejected. Referring to [13]-[16], an OCR with an FIC is theoretically capable of cancelling feedback signals that are +35 dB greater in power than the input signal, and an implemented OCR with an FIC can remove feedback signals +20 dB greater than the

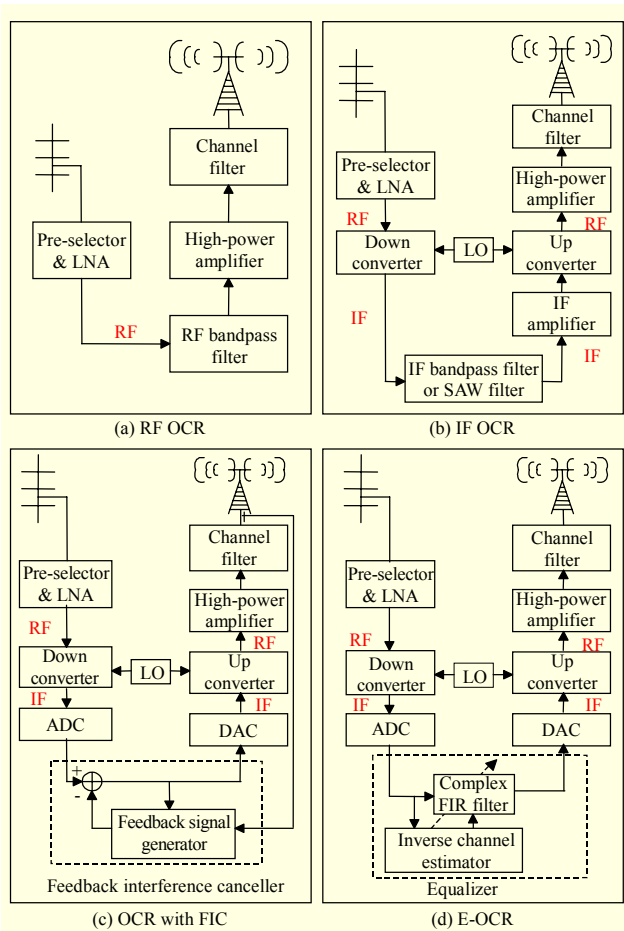

Fig. 2. Structures of conventional OCRs (LO: local oscillator).

input signal.

Figure 2(d) shows the digital type E-OCR, which includes an equalizer. The E-OCR provides a high-quality transmitting signal with high power because of the rejection capability of the feedback signals caused by insufficient antenna isolation and multipath signals existing between the main transmitter and the OCR. However, if the electric field strength of the feedback signals is higher than that of the input signal of the OCR, the equalizer in the E-OCR cannot cancel the feedback signal, thereby causing a malfunction of the E-OCR.

The characteristics of conventional OCRs are summarized in Table 1. T-DMB and DAB transmitting signals must meet the emission mask requirements [1]. However, with the exception of an E-OCR, conventional OCRs do not meet the emission mask requirements.

III. Proposed OCR

1. Properties and Structure of the Proposed OCR

Figure 3 shows the structure of the proposed OCR, which

overcomes the problems of conventional OCRs. The proposed OCR consists of a receiving antenna, receiver, digital signal processor, transmitter, and transmitting antenna. The receiver consists of a pre-selector, low-noise amplifier (LNA), first frequency down-converter, and first analog-to-digital converter (ADC). The digital signal processor (DSP) consists of an FIC and an equalizer. The transmitter consists of a digital-to-analog converter (DAC), frequency up-converter, high-power amplifier (HPA), and channel filter. In addition, a second frequency down-converter and second ADC are included for the FIC. The structure of the proposed OCR is a merged type of OCR with an FIC as shown in Fig. 2(c), and an E-OCR as shown in Fig. 2(d). The proposed OCR has the following characteristics:

- The proposed OCR can transmit a higher power signal than conventional OCRs because it cancels the feedback signals caused by insufficient antenna isolation through the FIC, which consists of a feedback channel estimator, the first complex finite impulse response (FIR) filter, and the subtractor.
- Because the proposed OCR removes multipath signals and compensates for the linear distortion existing between the main transmitter and the OCR through the equalizer, it can transmit a high-quality output signal. The inverse channel estimator of the equalizer, which operates in non-realtime, estimates the tap coefficients of the second complex FIR filter in the time domain, and the second complex FIR filter compensates for the channel distortion using the estimated information.
- The proposed OCR has a relatively short processing delay since it has the simple structure of the FIC and equalizer for channel compensation instead of using the FFT for demodulation and equalization, and it has the IFFT for re-modulation. The processing delay of the OCR is mainly determined by the reference tap location of the second complex FIR filter, so that the OCR whose processing delay is shorter than the guard interval can be implemented by adjusting the reference tap location.

The characteristics of the proposed OCR corresponding to those of the conventional OCRs are shown in the Table 1. Since the proposed OCR is a merged type OCR with an FIC and E-OCR, it can transmit a high-quality signal with high power.

2. Digital Signal Processing of the Proposed OCR

As shown in Fig. 3, the digital signal processing block of the proposed OCR consists of an FIC for cancellation of feedback signals and an equalizer for compensation of channel distortion. The FIC is comprised of a feedback channel estimator and a first complex FIR filter to generate a replica of feedback signals as well as a subtractor that cancels feedback signals by

Table 1. Characteristics of conventional OCRs.

| | Feedback rejection capability | Multipath rejection capability | Processing delay (<74 μs) | Output signal quality | Output power | Emission mask |
|--------------|-------------------------------|--------------------------------|--------------------------------|-----------------------|--------------|---------------|
| RF OCR | No | No | Pass (0.5–1 μs) | Low | Low | Fail |
| IF OCR | No | No | Pass (1–2 μs) | Low | Low | Fail |
| OCR with FIC | Yes (up to +20 dB) | No | Pass (10–20 μs) | Moderate | High | Fail |
| E-OCR | Yes (up to -1 dB) | Yes | Pass (adjustable) | High | Moderate | Pass |
| Proposed OCR | Yes (up to +27 dB) | Yes | Pass (adjustable, but > 25 μs) | High | High | Pass |

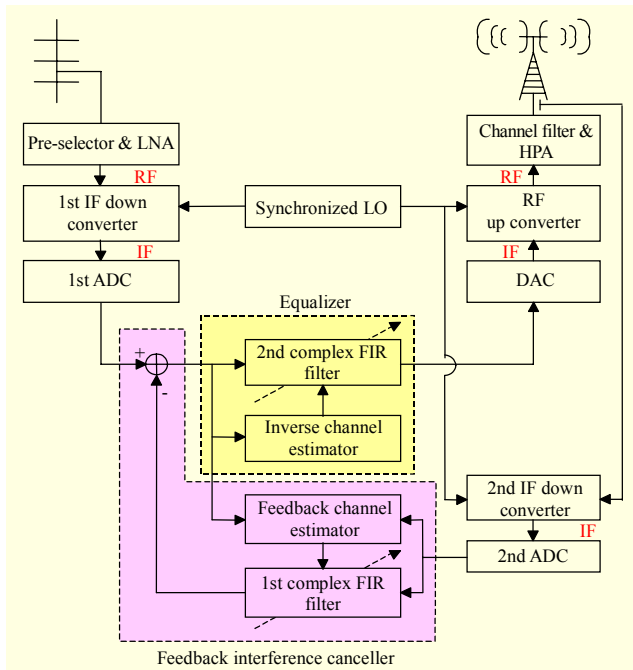

Fig. 3. Structure of the proposed OCR.

subtracting the replica of feedback signals from the receiving signal. The equalizer is comprised of an inverse channel estimator that estimates the inverse channel in non-realtime and a second complex FIR filter that compensates for the channel distortion caused by multipath and remaining feedback signals using the estimated inverse channel.

A. Feedback Interference Canceller

The FIC comprises a feedback channel estimator, a first complex FIR filter, and a subtractor.

The feedback channel estimator estimates the feedback channel caused by low isolation between transmitting and receiving antennas using the second down-converted signal and output signal of a subtractor.

The first complex FIR filter generates a replica of feedback signals by filtering the second down-converted signal using the

estimated feedback channel.

The subtractor removes feedback signals by subtracting a replica of feedback signals from a receiving signal of the OCR.

Let the second down-converted signal vector at time n be $\bar{s}_n = [s(n) \ s(n-1) \ \dots \ s(n-K+1)]^T$, where K is the number of the first complex FIR filter taps and T means transpose. Let the output signal of the subtractor at time n be $\varepsilon(n)$, and let the tap coefficients of the first complex FIR filter at time $n-1$ be $\bar{h}_{n-1} = [h_0(n-1) \ h_1(n-1) \ \dots \ h_{K-1}(n-1)]^T$. Then, the tap coefficients at time n can be calculated based on the least mean square (LMS) algorithm as

$$\bar{h}_n = \bar{h}_{n-1} + \lambda \cdot \varepsilon(n) \cdot \bar{s}_n^* \quad (1)$$

where λ is a constant for determining the convergence speed and $*$ is a complex conjugate. A replica of feedback signals $f(n)$ at time n is generated by filtering the second down-converted signal vector \bar{s}_n using tap coefficients \bar{h}_n as follows:

$$f(n) = \bar{h}_n^T \cdot \bar{s}_n^* \quad (2)$$

Finally, feedback signals are cancelled by subtracting the replica of feedback signals $f(n)$ from the receiving signal $r(n)$ of the OCR, and the output signal $\varepsilon(n)$ of the subtractor is calculated as

$$\varepsilon(n) = r(n) - f(n) \quad (3)$$

B. Equalizer

As shown in Fig. 4, the equalizer of the proposed OCR consists of an inverse channel estimator that estimates the inverse channel periodically (non-realtime), and a complex FIR filter that compensates for the channel distortion caused by the multipath and remaining feedback signals using the estimated inverse channel. The inverse channel estimator comprises a demodulator, a channel estimator, and an inverse converter.

i) The demodulator sends the received phase reference symbol (PRS) for channel estimation to the channel estimator.

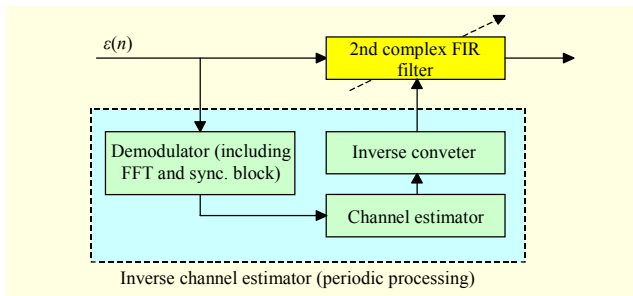

Fig. 4. Structure of the equalizer.

To obtain the received PRS, the processes of frame synchronization, symbol synchronization, frequency synchronization, and demodulation are required.

ii) The channel estimator estimates the channel distortions (multi-path, linear distortion, and remaining feedback signals) of the received signal using the PRS, which is a predefined pilot signal between the main transmitter and the OCR. Channel estimation is performed by comparing the extracted pilot signal from the demodulator with the predefined PRS in the frequency domain.

iii) The inverse converter converts the inverse of the estimated channel distortions in the frequency domain into the tap coefficients of the second complex FIR filter in the time domain while maintaining stability and causality.

IV. Computer Simulation and Laboratory Test

1. Computer Simulation

In a computer simulation, the performance of a T-DMB receiver using a conventional OCR with FIC and using the proposed OCR was evaluated in a modified Brazil channel A including a feedback signal. In the general location where an OCR is installed, the line of sight (LOS) from the main transmitter is guaranteed, which has a static channel with a carrier-to-noise ratio (CNR) greater than 30 dB. This channel, called the modified Brazil channel A, is shown in Table 2 [12], [17]. The feedback signal was modeled having a power 40 dB greater than that of the desired signal. In addition, the feedback signal was assumed to be delayed by 31 μ s due to the processing time of the OCR and the propagation delay between the transmitting and receiving antennas. The first complex FIR filter for the FIC used 21 taps, and the second complex FIR filter for the equalizer used 600 taps (20 pre-taps and 580 post-taps). The detailed parameters for the computer simulation are shown in Table 3.

We assumed that there were no synchronization errors and no forward error correction code since the purpose of the simulation was only to compare the performance of the T-DMB receiver

Table 2. Channel profile of modified Brazil channel A.

| | Delay (μ s) | Amplitude (dB) | Phase ($^\circ$) |
|---------------|------------------|----------------|--------------------|
| Main signal | 0.0 | 0.0 | 0 |
| Post-ghost #1 | 0.15 | -13.8 | 0 |
| Post-ghost #2 | 2.22 | -16.2 | 0 |
| Post-ghost #3 | 3.05 | -14.9 | 0 |
| Post-ghost #4 | 5.86 | -13.6 | 0 |
| Post-ghost #5 | 5.93 | -16.4 | 0 |
| Feedback | 31.0 | +40 | 0 |

Table 3. Simulation parameters.

| Parameters | Specifications |
|--|-------------------------------------|
| IF center frequency | 2.048 MHz |
| CNR | 10-30 dB |
| Number of first complex FIR filter taps | 21 |
| Number of second complex FIR filter taps | 600 (20 pre-taps and 580 post-taps) |
| Processing delay | 33 μ s |
| Channel | Modified Brazil A |

using the proposed OCR and using a conventional OCR with an FIC. Figure 5 shows the bit error rate (BER) performance of a T-DMB receiver after differential demodulation when the proposed OCR and the OCR with an FIC were used. The channel between the main transmitter and the OCR used a modified Brazil channel A with a 30 dB CNR and +40 dB feedback signal, and the channel between the OCR and T-DMB receiver used AWGN and Brazil channel A. In Figs. 5(a) and (b), the x-axis denotes the SNR and the y-axis denotes the BER. As seen in Fig. 5, the performance of the legacy T-DMB receiver receiving from the OCR with an FIC was degraded by about 1.5 dB in an AWGN channel and 3 dB in Brazil channel A at a BER of 10^{-3} compared to receiving from the proposed OCR. If the OCR does not perform proper equalization on the received signals, the multipath and residual feedback signals after FIC operation are amplified and retransmitted by the OCR. These distortions may be combined with channel distortions between the OCR and the T-DMB receiver, resulting in performance degradation of the legacy T-DMB receiver; therefore, it is crucial to deploy an equalizer within the OCR to increase the coverage of the OCR.

2. Laboratory Test Results

To verify the performance of the proposed OCR, the hardware

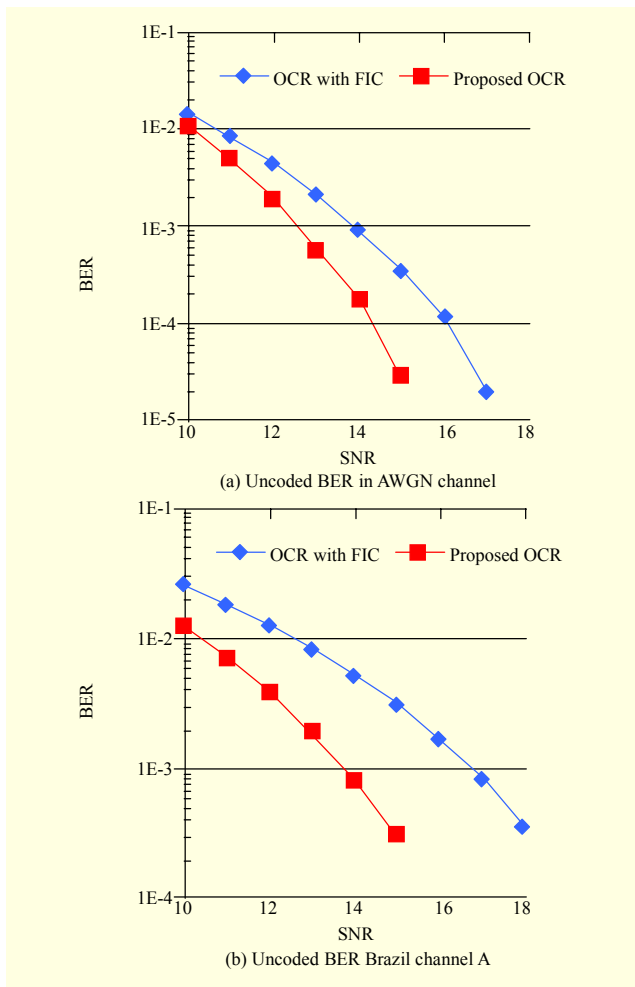

Fig. 5. BER of T-DMB receiver vs. SNR in modified Brazil channel A (CNR = 30 dB, feedback signal = +40 dB) between a main transmitter and OCR, and AWGN and Brazil channel A between OCR and T-DMB receiver.

was implemented and tested in a laboratory. The implemented digital signal processing module consists of an FIC to cancel feedback signals, a demodulator that extracts the PRS from the received signal, a DSP that periodically performs channel estimation and inverse conversion every 96 ms corresponding to one T-DMB transmission frame (non-realtime), and a complex FIR filter that compensates for the distortion of the received channel. The first complex FIR filter of the FIC used 21 taps, and the second complex FIR filter of the equalizer used 200 taps (20 pre-taps and 180 post-taps). Figure 6 shows the input and output channel impulse response (CIR) of the proposed OCR in the modified Brazil channel A including a +27 dB feedback signal with 30 dB CNR. As seen in Fig. 6, the implemented OCR significantly suppressed the feedback signal caused by insufficient isolation between transmitting and receiving antennas and the multipath signals between the main transmitter and equalization OCR. In particular, a feedback

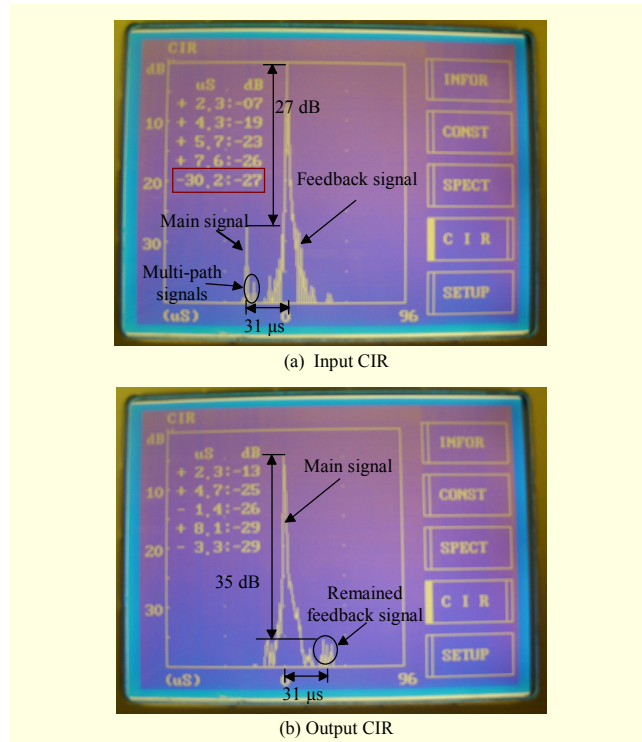

Fig. 6. Input/output CIR of the proposed OCR in modified Brazil channel A with a 27 dB feedback signal and 30 dB CNR.

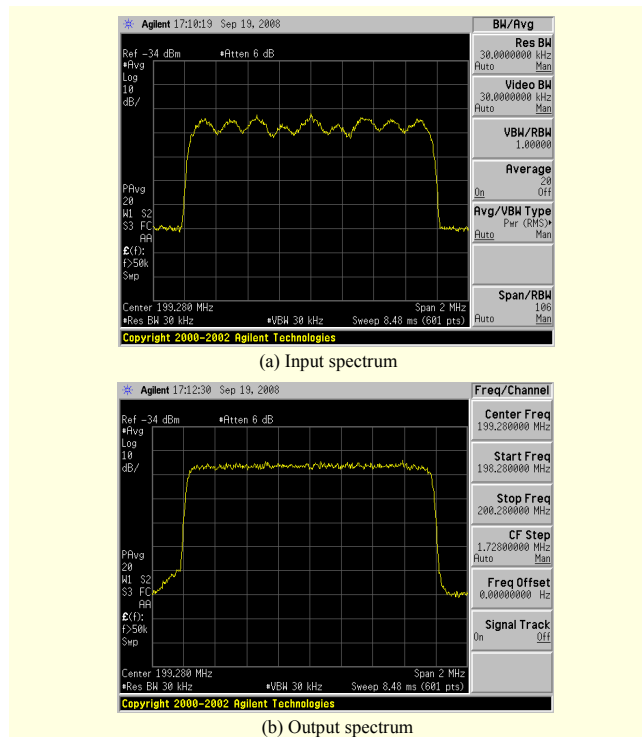

Fig. 7. Input/output spectrum of the proposed OCR in modified Brazil channel A with a 30 dB CNR, which has no feedback signal.

signal +27 dB greater in power than the input signal was

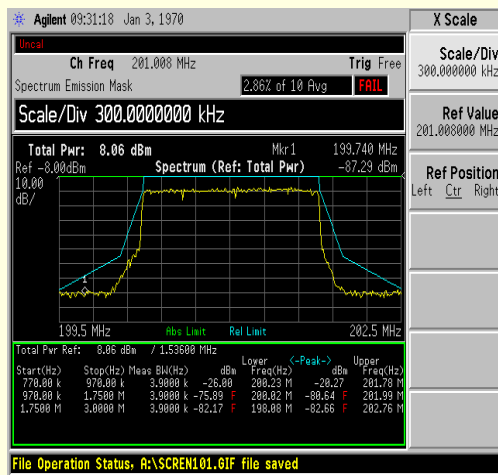
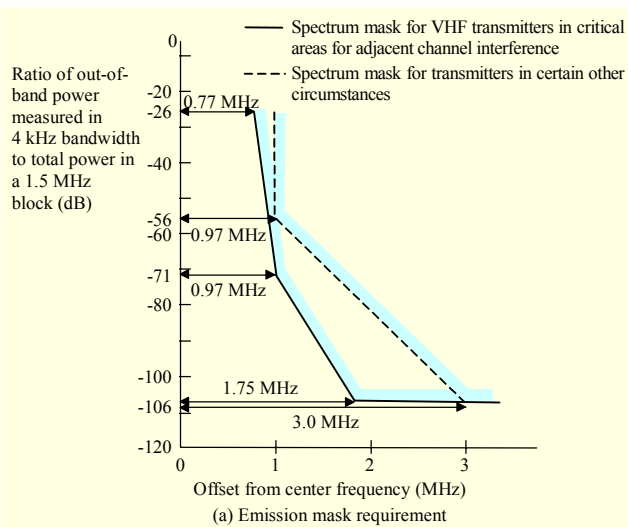

Fig. 8. Emission mask requirement of T-DMB transmitting signal and mask test result of the proposed OCR.

suppressed by more than +50 dB, which is about +35 dB less than the input signal. Figure 7 shows the input and output spectra of the proposed OCR in the modified Brazil channel A with a 30 dB CNR, which has no feedback signal. The proposed OCR clearly removed the multipath signals between the main transmitter and the equalization OCR.

A T-DMB transmitting signal must meet the emission mask requirements shown in Fig. 8(a). The emission mask applies to “VHF transmitters in critical areas for adjacent channel interference and VHF transmitters in other circumstances” [1].

As shown in Fig. 8(b), the implemented OCR meets the constrained requirements.

V. Conclusion

This paper considered the technical requirements of OCRs in broadcasting T-DMB signals in an SFN environment and

proposed an equalization OCR with an FIC to meet such requirements. The proposed OCR uses an FIC to cancel feedback signals and a time-domain equalizer to compensate for channel distortions such as multipath signals. Computer simulation and laboratory test results demonstrated that the proposed OCR provides a higher-quality transmitting signal with higher output power than conventional OCRs and satisfies the emission mask requirement of a T-DMB transmitter.

The proposed OCR is currently operated by the Korean Broadcasting System (KBS), which is a major broadcaster in Korea, and it can easily be extended to other standards, such as digital video broadcasting-terrestrial/handheld, integrated services digital broadcasting-terrestrial, Wibro, and so on. The use of the proposed OCR instead of conventional OCRs can be easily implemented and will result in higher performance of T-DMB networks while requiring less frequency resources.

References

- [1] ETSI, *Radio Broadcasting Systems; Digital Audio Broadcasting (DAB) to Mobile, Portable, and Fixed Receivers*, ETSI EN 300 401 v.1.3.3, Sept. 2001.
- [2] S. Cho et al., “System and Services of Terrestrial Digital Multimedia Broadcasting (T-DMB),” *IEEE Trans. on Broadcasting*, vol. 53, no. 1, Mar. 2007, pp. 171-178.
- [3] G. Lee et al., “Development of Terrestrial DMB Transmission System Based on Eureka-147 DAB Systems,” *IEEE Trans. on Consumer Electronics*, vol. 51, no. 1, Feb. 2005, pp. 63-68.
- [4] Y. Lee et al., “Field Trials for Terrestrial Digital Multimedia Broadcasting System,” *IEEE Trans. on Broadcasting*, vol. 53, no. 1, Mar. 2007, pp. 425-433.
- [5] A. Mattsson, “Single Frequency Networks in DTV,” *IEEE Trans. on Broadcasting*, vol. 51, no. 4, Dec. 2005, pp. 413-422.
- [6] K. Salehian et al., “On-Channel Repeater for Digital Television Broadcasting Service,” *IEEE Trans. on Broadcasting*, vol. 48, no. 2, June 2002, pp. 97-102.
- [7] ATSC, *Recommended Practice: Design Of Synchronized Multiple Transmitter Networks*, Doc. A/111, Sept. 2004.
- [8] ETSI, *Digital Video Broadcasting (DVB): DVB Mega-frame for Single Frequency Network (SFN) Synchronization*, TS 101 191 v. 1.1.1.1, Apr. 1997.
- [9] ETSI, *Digital Audio Broadcasting (DAB); Guidelines and Rules for Implementation and Operation, Part 2: System Features*, ETSI TR 101 496-2 v.1.1.2, May 2001.
- [10] S.I. Park et al., “Equalization On-Channel Repeater for Terrestrial Digital Multimedia Broadcasting System,” *IEEE Trans. on Broadcasting*, vol. 54, no. 4, Dec. 2008, pp. 752-760.
- [11] S.W. Kim et al., “Equalization Digital On-Channel Repeater in Single Frequency Networks,” *IEEE Trans. on Broadcasting*, vol. 52, no. 2, June 2006, pp. 23-37.

- [12] Y.T. Lee et al., "A Design of Equalization Digital On-Channel Repeater for Single Frequency Network ATSC System," *IEEE Trans. on Broadcasting*, vol. 53, no. 1, Mar. 2007, pp. 23-37.
- [13] A. Wiewiorka and P.N. Noss, "Digital On-Channel Repeater for DAB," BBC R&D White Paper WHP120, BBC, Sept. 2005.
- [14] Technical Document on "Transposer/Gap-Fillers R&S XLx8000." Available: <http://www.rohde-schwarz.com>
- [15] Technical Document on "TX-DAB100 OCR." Available: <http://www.txdigicast.com/prod2.htm>
- [16] Technical Document on "PT2090 Digital Repeater." Available: <http://www.protelevision.com>
- [17] Mackenzie, ABERT/SET Group, Mackenzie Institute, "General Description of Laboratory Tests," DTV Field Test Report in Brazil, July 2000.



Sung Ik Park received the BSEE from Hanyang University, Seoul, Korea, in 2000, and the MSEE from POSTECH, Pohang, Korea, in 2002. Since 2002, he has been with the Broadcasting System Research Group at ETRI, where he is a senior member of research staff. In addition, he is currently at Chungnam National University pursuing his PhD. His research interests are in the areas of error correction codes and digital communications, in particular, signal processing for digital television.



Homin Eum received the BSEE and MSEE from Korea University, Seoul, Korea, in 1998 and 2000, respectively. Since May 2000, he has been with the Broadcasting System Research Department at ETRI, where he is a senior member of research staff. His main research interests are in the areas of digital communication systems, digital signal processing, and DTV transmission systems.



So Ra Park received the BSEE and MSEE from Sungkyunkwan University, Korea, in 1995 and 1999, respectively. Since 1999, she has been with the Broadcasting System Research Group at ETRI, where she is a senior member of research staff. Her research interests are in the areas of digital modem and digital communications, in particular, signal processing for digital broadcasting.



Geon Kim received the BSEE and MSEE from Chung-Ang University, Seoul, Korea, in 1997 and 1999, respectively. Since 1999, he has been with the Broadcasting System Research Group at ETRI, where he is a senior member of research staff. His research interests are in the areas of digital signal processing and VLSI design, in particular, signal processing for digital broadcasting.



Yong-Tae Lee received the BSEE and MSEE from Hankuk Aviation University in 1993 and 1995, respectively, and the PhD from Yonsei University, Seoul, Korea, in 2007. Since 1995, he has been with the Broadcasting System Research Department at ETRI, where he is a principal member of research staff. His research interests are in the areas of digital signal processing and RF signal processing, in particular, signal processing for digital television, digital communications and analog narrow band communications.

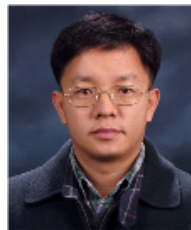

Heung Mook Kim received the BSEE and MSEE in electronics and electrical engineering from POSTECH, Pohang, Korea, in 1993 and 1995, respectively. From February 1995 to January 2002, he was with POSCO Technology Laboratory in the field of measurement and monitoring as research engineer. Since February 2004, he has been with the Broadcasting System Research Department at ETRI, where he is currently a leader of the Terrestrial Broadcasting Technology Research Team. His research interests are digital signal processing and RF transmission for digital communication systems.



Wangrok Oh received the BS, MS, and PhD degrees from Pohang University of Science and Technology (POSTECH), Pohang, Korea, in 1994, 1997, and 2003, respectively. From 1997 to 2000 and from 2003 to 2006, he was with POSTECH Information Laboratories (PIRL), Korea, as a full-time research staff member and worked on the development of various communications systems. He is currently with Chungnam National University (CNU), Daejeon, Korea, as an assistant professor. His current research interests include turbo and turbo-like codes, design and implementation of various communication systems, space-time codes, and MIMO systems.