

JPE 9-6-11

DP Formulation of Microgrid Operation with Heat and Electricity Constraints

Minh Y Nguyen^{*}, Nack-Hyun Choi^{*}, and Yong-Tae Yoon[†]

[†]Dept. of Electrical Engineering & Computer Science, Seoul National University, Seoul, Korea

ABSTRACT

Microgrids (MGs) are typically comprised of distributed generators (DGs) including renewable energy sources (RESs), storage devices and controllable loads, which can operate in either interconnected or isolated mode from the main distribution grid. This paper introduces a novel dynamic programming (DP) approach to MG optimization which takes into consideration the coordination of energy supply in terms of heat and electricity. The DP method has been applied successfully to several cases in power system operations. In this paper, a special emphasis is placed on the uncontrollability of RESs, the constraints of DGs, and the application of demand response (DR) programs such as directed load control (DLC), interruptible/curtailable (I/C) service, and/or demand-side bidding (DSB) in the deregulated market. Finally, in order to illustrate the optimization results, this approach is applied to a couple of examples of MGs in a certain configuration. The results also show the maximum profit that can be achieved.

Keywords: Microgrids, Distributed generators, Unit commitment, Optimization, Dynamic programming

1. Introduction

As society enters a new digital age, the electric supply infrastructure is required to provide not only a greater amount of electricity, but also higher levels of Security, Quality, Reliability and Availability (SQRA) ^[1]. The Electric Power Industry (EPI), in response, is undergoing a major change in which a competitive market is being implemented while electric network operations are being decentralized. The higher level of DG penetration into distributed networks, together with storage devices, has

brought about the concept of Microgrids (MGs). In general, MGs are low-voltage distribution networks comprised of various DGs, storage devices and controllable loads that can operate either interconnected with or isolated from the main distribution grid as a controllable entity ^[4]. DGs are comprised of several power generation technologies. These include generators that are controllable such as diesel engines, microturbines (MTs), fuel cells (FCs), and combined heat and powers (CHPs) as well as uncontrollable RESs such as photovoltaics (PVs) and wind power (WP). The capacity of DGs can range from a few kW to several MWs ^[5].

One advantage of MGs is their ability to use RESs as main sources of power ^[3]. Recent developments in RES technologies have made them affordable even when

Manuscript received Aug. 17, 2009; revised Sept. 25, 2009

[†]Corresponding Author: ytyoon@snu.ac.kr

Tel: +82-2-880-9144, Fax: +82-2-878-1452, Seoul Nat'l Univ.

^{*}Dept. of Electrical Engineering & Computer Science, Seoul National University, Korea

compared with traditional methods of power generation. The cost of producing electricity by WP has declined from 40 ¢ to 5¢ per kWh and cost of producing electricity from PVs has dropped from \$1 to 20¢ per kWh [3].

One prerequisite or difficulty of MG implementation is the use of storage devices such as flywheels, super capacitors and batteries. The ability to charge and discharge electricity plays an important role when there is a shortage of capacity or a surplus of supply due to RESs, and/or when the short-run marginal cost (SRMC) of power generation becomes too high, etc. In other words, storage devices can help with balancing the demand and the supply in real time. Even though some storage devices like batteries have been in use for a long time, their application in EPs, up to now, has been very limited because of their high cost.

In order to deal with load fluctuations, there are other solutions called, “demand response” (DR) programs, that are much more feasible. Basically, DR programs work by providing incentives to customers to interrupt or reduce their consumptions, or by setting appropriate electricity prices that vary with time. In this paper we shall refer them as incentive-based programs and time-based programs, respectively [8]. From the system operator’s point of view, DR programs are similar to creating backup sources of power for using in times when there is a shortage in generation relative to demand.

Based on the above we consider a scenario and formulate the operation of MGs with the goal of providing backup sources of power. In the formulation, new impact factors were taken into account with the objective of maximizing profit. Optimization is done by optimizing the output of DGs, the electricity exchanges with the main distribution grid when interconnected, the implementation of the storage devices, as well as the DR program. For that purpose, this paper is presented as follows: the notations are listed in Section 2; MGs configuration is discussed in Section 3; the DR program is in Section 4; Section 5 is devoted to the formulation of the objective function; the solution by the DP method is presented in Section 6; finally the case studies and conclusions are shown in Sections 7 and 8.

2. Notations

- k : stage number k^{th} .
- i : generator number i^{th} .
- $u_{k,i}$: control unit, where [$u_k=0$ means OFF and $u_k=1$ means ON].
- $x_{k,i}$: state variable, which indicates how many hours a generator has been on or off.
- R_k : revenue, [USD].
- $c_{G,i}(P_{k,i})$: cost of generating $P_{k,i}$, [USD].
- $C_{k,i}^{up/dn}$: start-up and shut-down cost costs, [USD].
- S_i, T_i : start-up and shut-down costs, respectively, [USD/time].
- c_i^{fix} : fixed costs, [USD/hour].
- $P_k^e; P_k^h; P_{k,ex}^e$: electric load, heat load and electricity exchange with the main distribution grid, respectively [kW]; ($P_{k,ex}^e > 0$ means that the MG is importing, while $P_{k,ex}^e < 0$ means that it is exporting).
- $\rho_k^e; \rho_k^h; \rho_{k,sell}^e; \rho_{k,buy}^e$: electric price, heat price, prices of selling electricity to and buying electricity from the main distribution grid, respectively [USD/kWh].
- $P_{k,i}$: power output of the generator, [kW].
- $C_{k,ex}$: cost of exchanging electricity with main the distribution grid, [USD].

3. Microgrid configuration

The MG configuration in [Fig. 1], was proposed by the National Renewable Energy Laboratory (NREL) in the *Homer* software program [12]. In this configuration, the MG sources are connected to either an AC network or a DC network while the AC and DC networks are connected via appropriate converters.

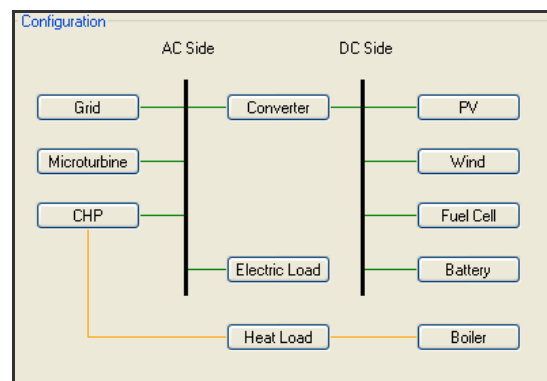

Fig. 1. Microgrid Configurations.

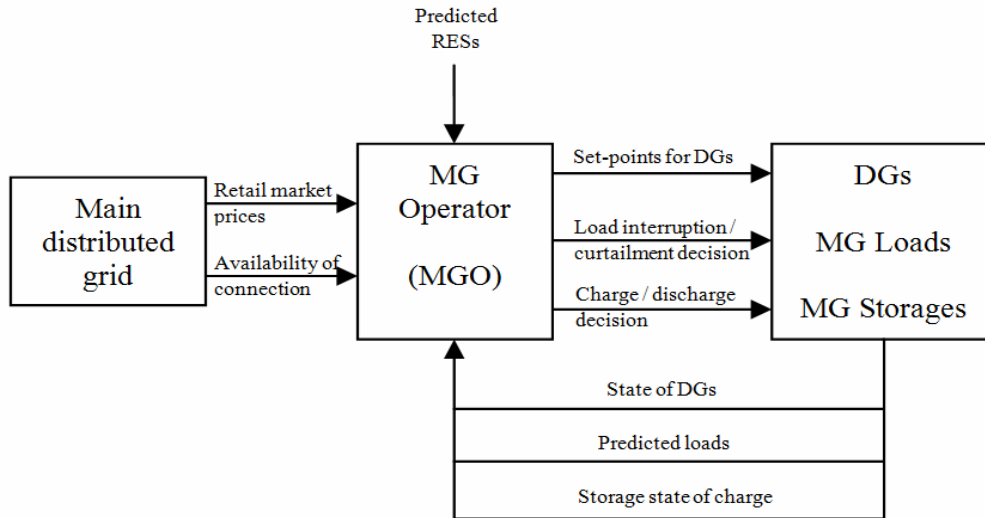

Fig. 2. The role of MGOs in Microgrids.

Homer was developed to design MGs under such circumstances by minimizing the Net Present Cost (NPC) in the long-term. Optimal operation is determined by an approximation that may be very different than actual short-term operations. This paper will present a novel DP formulation for accurate short-term MG operation in terms of maximizing profit. This is done by adding more technical constraints than long-term approximations, as well as the impact of the electric power market. Optimization is performed based on short-term operation (i.e. one day), so some components related to long-term considerations will be absent in the objective function, including capital costs and replacement costs.

In this paper, the role of MGOs can be seen in fig. 2. It is shown that MGOs are getting information on MG components, forecasting RESs and their loads, as well as looking at electricity prices in the retail market, to determine optimal operation. Optimization is done by controlling the DG's production, the amount of electricity exchanged with the main distribution grid, the decisions of charging/discharging the storage device and the decisions of load interruption/curtailment. These signals will be sent to the controllers of each of the MG's components (primary controller) and demand controllers.

In operation, it is obvious that RESs like WP and PVs, due to their fuel-free operation, are supposed to generate

as much power as they can, depending on the availability of natural resources, i.e. "nondispatchable sources". On the other hand, fuel-consuming sources like CHPs, MTs and FCs need to be continually adjusted to maximize profit. We refer to these as "dispatchable sources."

3.1 Nondispatchable sources

As mentioned above, nondispatchable sources, referring to RESs, in this paper are: WP and PVs. Their operations depend completely on the availability of natural resources (wind speed, solar illumination, ambient temperature, etc). Fortunately, since natural resources can be predicted with some accuracy, these kinds of sources can be seen as a negative load by system operators (SO)s.

The power output of PV panels can be calculated as follows [3]:

$$P_{PV} = P_{rated} \cdot \left(\frac{R_t}{R_{rated}} \right) \cdot (1 + \alpha (T_t - T_{rated})) \quad (1)$$

where R_{rated} and T_{rated} are standard radiation, [sun] and temperature, [°C]; R_t and T_t are radiation, [sun] and temperature, [°C] at time t ; α is the temperature coefficient, [μ unit/°C]; P_{rated} and P_{PV} are the rated capacity, [kW] and the power output, [kW].

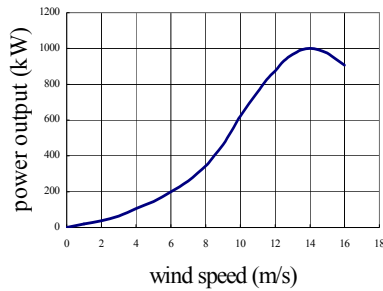

Fig. 3. Wind power generation characteristics.

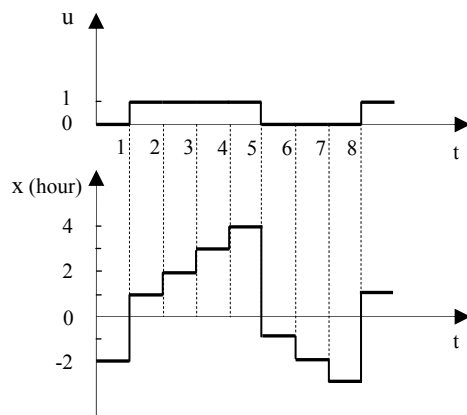

Fig. 4. Example of minimum up time, minimum down time.

The utilization of WP is quite complicated due to the aero-dynamic interaction between the air flow and the blades of a wind turbine. However, the power output of a WP plant associated with a change in wind speed is always assumed to be known by the MGO. Fig. 3 shows the typical generation characteristics of WP^[12]. It reaches the maximum capacity (1MW) at a wind speed of 14 m/s. When the wind speed is higher than 16 m/s, WP is stopped to avoid damage to the blades of wind turbines.

3.2 Dispatchable sources

This term refers to the fuel-consuming DGs whose capacities ranges from a few kW to 10 MW such as CHPs, MTs, FCs and the boilers in this paper. A lot of the benefits associated with DGs can be listed. These include production cost mitigation, high efficiency (CHPs), low or no emission, security enhancement and low noise levels (FCs). Unlike conventional centralized generators, which are online for their entire lifetime for serving customers in

a large area (except for maintenance and repair time), the consecutive serving of a small area, together with the contingency of RESs, require DGs to be controlled continuously: they may be turned on/off frequently in a single day. The speed of thermal processes is much lower than that of electric, causing the concern of how long we can turn on/off the DGs associated with thermal processes. This points out the concepts of minimum up time (t^{up}) and minimum down time (t^{dn}); the time (in hours) that DGs have to remain on or off until they can change their operation state (off or on, respectively). Fig. 4 is an example of a DG that has a $t^{up}=4$ and a $t^{dn}=2$.

Where x and u are defined as above, a negative value of x (-2) means the DG has been off (for 2 hours) and a positive value (4) means it has been on (for 4 hours). The following equation shows the relationship between u and x :

$$x_{k+1,i} = \begin{cases} \max(1, x_{k,i} + 1) & \text{if } u_{k+1,i} = 1 \\ \min(-1, x_{k,i} - 1) & \text{if } u_{k+1,i} = 0 \end{cases} \quad (2)$$

3.3 Storage Devices

Storage devices, together with DGs, play a central role in the concept of MGs. Although there are some storage technologies being considered for MGs including thermal storage, hydro storage, flywheels and super-capacitors, batteries are still the most prevalent. Although a lot of advantages have been discussed in many papers, this cannot hide the fact that their price is too high. A simple calculation of the cost of using batteries^[12], is called the battery wear cost, C_{bw} [\$/kWh].

$$C_{bw} = \frac{C_{rep,bat}}{N_{bat} \cdot Q_{lifetime} \cdot \sqrt{\eta_{rt}}} \quad (3)$$

where $C_{rep,bat}$ is the replacement cost of a battery bank, [\$/]; N_{bat} is number of batteries in the bank; $Q_{lifetime}$ is the lifetime throughput of a single battery, [kWh] and η_{rt} is the battery roundtrip efficiency (fractional). Assume that such a battery has a fixed lifetime throughput or that the total amount of electricity charged and discharged through the battery is unchangeable. One typical battery type Trojan L16P has a $C_{rep,bat} = 220$ \$, a $Q_{lifetime} = 1075$ kWh and a $\eta_{rt} = 0.85$. As a result, the battery wear cost is

around 22 ¢/kWh, almost equal to the cost of WP generation despite the fact that it does not create any electricity. Therefore, in this paper, this cost is ignored, and we just observe how batteries can help MG operation with free charging and discharging.

4. Demand response programs

A DR program is proposed based on the concept of sharing benefits between providers and customers. That is, in some special cases such as a shortage of capacity or when the SRMC is too high, customers, who have signed an I/C contract, are willing to shift or curtail their load and receive incentives from their providers. DR programs are divided into two basic categories: time-based programs and incentive-based programs [9]. In time-based programs, the price varies every hour: real time pricing (RTP), or in a certain block: time of use (TOU), or during critical peak hours: critical peak pricing (CPP), which occurs once or twice per month. In incentive-based programs, providers allow customers to freely choose special prices associated with a certain level of reliability: interruptable/curtailable service (I/C); load directed control (LDC), etc. or give customers incentives based on the amount of electricity shifted: demand-side bidding (DSB), etc. Sometimes, these separations are not clear, for instance, in an I/C program the provider might leave the customer the option to choose whether to follow the signals of interruption or to remain consuming at an extremely high price, it is similar to a CPP program.

DR programs have been applied successfully in wholesale markets, but in the retail market, it faces several obstacles: (1) the cost of electronic meters and communication is not a problem with wholesale customers, but it is in the retail market; (2) retail customers usually lack the time and capability to follow either the change of price or the signal dispatched by SOs. As a result, its benefits are not highlighted in this case. The most feasible programs are: LDCs where the SO can take control of some of the nonsensitive load (air conditioners, heaters, etc) and I/C services where the customers sign a contract to be offered a special price associated with a certain level of reliability.

5. Formulations

As mentioned above, this paper only deals with short-term optimization. As a result, only costs related to short-term operation are taken into account: generation costs, start-up costs, shut-down costs and fixed costs [2, 10].

5.1 Revenue

$$R_k = P_k^e \cdot \rho_k^e + P_k^h \cdot \rho_k^h \quad (4)$$

5.2 Generation costs

$$c_{G,i}(P_{k,i}) = u_{k,i} \cdot (a \cdot P_{k,i}^2 + b \cdot P_{k,i} + c) \quad (5)$$

5.3 Start-up and shut-down costs

$$C_{k,i}^{up/dn} = u_{k,i} \cdot I(x_{k-1,i} < 0) \cdot S_i + (1 - u_{k,i}) \cdot (c_i^{fix} + I(x_{k-1,i} > 0) \cdot T_i) \quad (6)$$

5.4 Cost of electricity exchanging electricity with the main distribution grid

$$C_{k,ex} = \begin{cases} P_{k,ex}^e \cdot \rho_{k,buy}^e & \text{if } P_{k,ex}^e \geq 0 \\ P_{k,ex}^e \cdot \rho_{k,sell}^e & \text{if } P_{k,ex}^e < 0 \end{cases} \quad (7)$$

5.5 Profit

$$\Pi_k = R_k - \sum_i^N c_{G,i}(P_{k,i}) - \sum_i^N C_{k,i}^{up/dn} - C_{k,ex} \quad (8)$$

5.6 Constraints

- Minimum up-time/down-time constraint:

$$u_{k,i} = \begin{cases} 1 & \text{if } 1 \leq x_{k,i} < t_i^{up} \\ 0 & \text{if } -1 \geq x_{k,i} > -t_i^{dn} \\ 0 \text{ or } 1 & \text{other case} \end{cases} \quad (9)$$

- State transition constraint:

$$x_{k+1,i} = \begin{cases} \max(1, x_{k,i} + 1) & \text{if } u_{k+1,i} = 1 \\ \min(-1, x_{k,i} - 1) & \text{if } u_{k+1,i} = 0 \end{cases} \quad (10)$$

- Capacity constraint:

$$P_{\min,i} \leq P_{k,i} \leq P_{\max,i} \tag{11}$$

- Demand constraint:

$$\sum_i P_{k,i}^e + P_{k,ex}^e \geq P_{k,load}^e \tag{12}$$

$$\sum_j P_{k,j}^h \geq P_{k,load}^h$$

- Battery minimum state of charge constraint:

$$(SoC)_k \geq (SoC)_{\min} \tag{13}$$

- Battery maximum Rate of Charge constraint:

$$I_k^{charge} \leq I_{\max}^{charge} \tag{14}$$

- Converter capacity constraint:

$$P_k^{convert} \leq P_{\max}^{convert} \tag{15}$$

- Transmission capacity constraint:

$$P_k^{trans} \leq P_{\max}^{trans} \tag{16}$$

5.7 Objective function

The objective function is maximizing the total profit for a 24 hour period:

$$\max_{u_{k,j}} \left\{ \sum_{k=1}^{24} \Pi_k \right\} \tag{17}$$

6. Dynamic programming method

6.1 Dynamic Programming Frame [11]

- Control unit: u_i is defined as the decision of whether to turn the generator on or off, [0 or 1].

- State variables:

+ With DGs, the state variable x_i is defined that indicates how many hours a generator i^{th} has been on or off, [$-t_i^{dn} \sim t_i^{up}$].

+ With batteries, the state variable x_{bat} is defined to be the state of charge (SoC) of a battery, [$SoC_{\min} \sim 100\%$]. Since the rate of charge is limited by the maximum rate of charge, a battery can only be charged with a certain amount of electricity which depends on its current SoC.

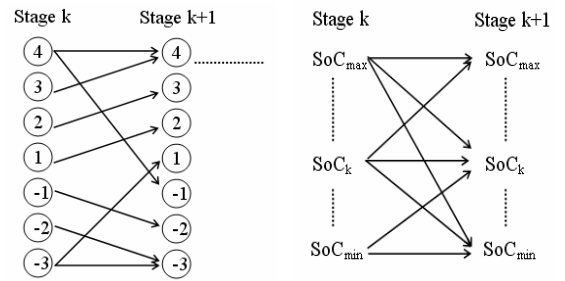

Fig. 5. Generator and Battery state transitions.

- State transition: Fig. 5 shows the state transition of a generator ($t_{\min}^{dn} = 3, t_{\min}^{up} = 4$) and a battery respectively.

6.2 Dynamic Programming Algorithm

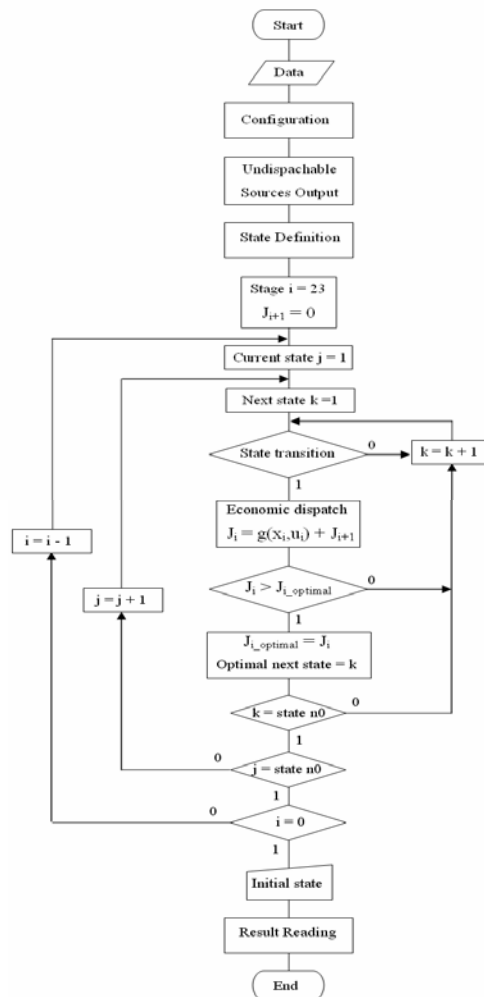

Fig. 6. Dynamic Programming Algorithm.

7. Case of studies

In this section, the proposed formulation is applied to two different MG configurations. The two configurations are operating in different modes: in isolation and with interconnection. In both cases, the optimization is done by optimizing the DG's output, the charge/discharge decision and the power exchange with the main distribution grid in the interconnected mode. The DR program is not implemented these examples.

7.1 Case 1

This case considers a MG in the isolated mode that has CHPs (ratio of heat to total power output is 0.3), WP, PVs, and a boiler, working with a bank of batteries, supplying a load of both heat and electricity [Fig. 7]. The MGO receives prices from the retail market, assumed to be an hourly price, predicts loads and RESs to determine the optimal operation for the following day. In this case the maximum total profit in a 24 hour period is \$1614.33.

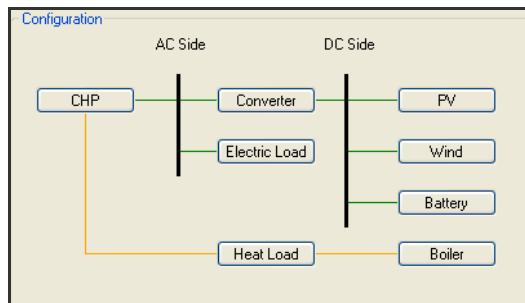
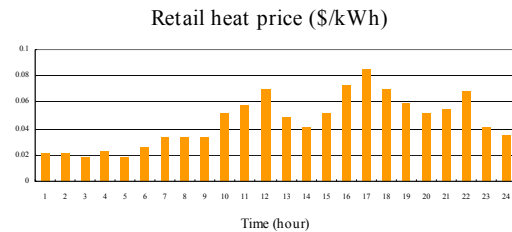
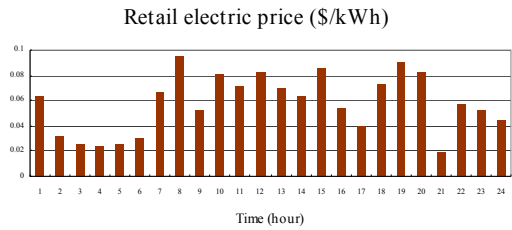
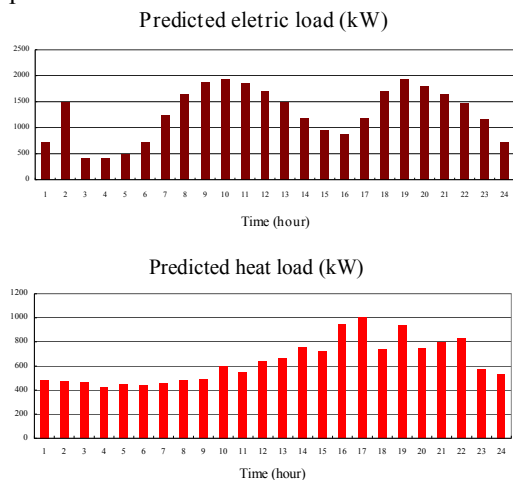
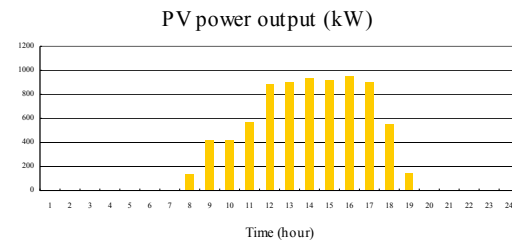
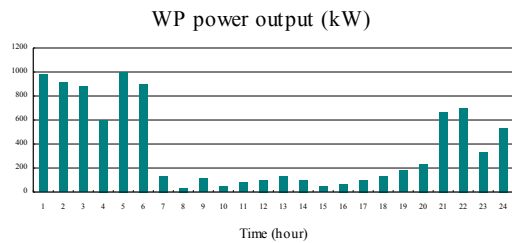

Fig. 7. Microgrid configuration in case 1.

Input data:



Nondispatchable sources of power output:



Optimal operation of dispatchable sources:

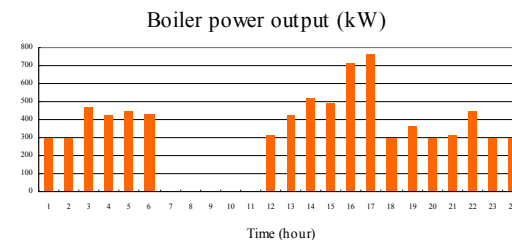
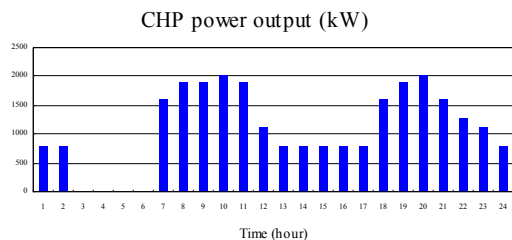

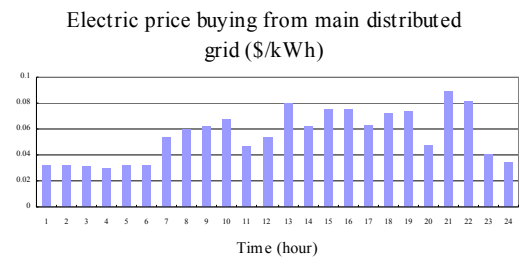
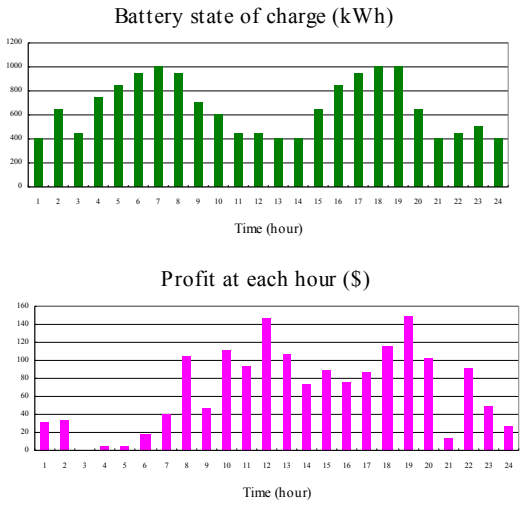

Optimal operation of dispatchable sources:

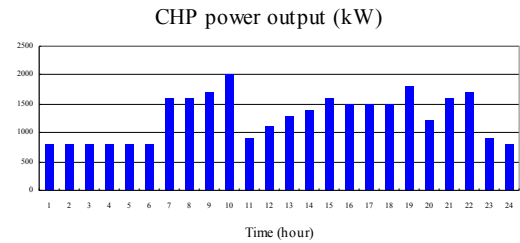
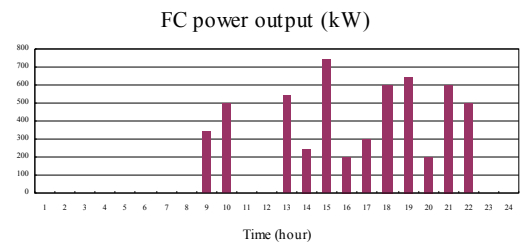
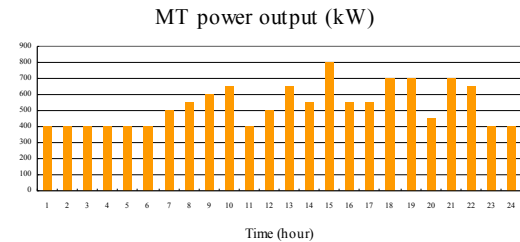
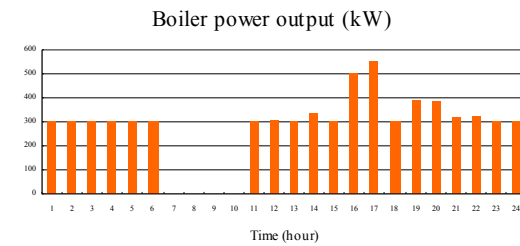
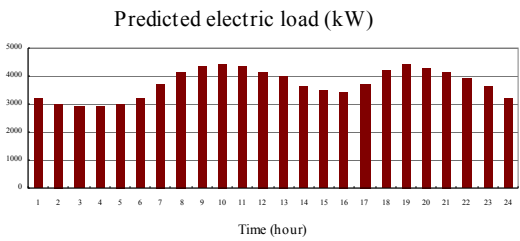

Fig. 8. The results of simulation in case 1.

7.2 Case 2

This case is an expansion from case 1, where a MG is added (FCs and MTs) and connected to the main distribution grid [Fig. 1]. It is assumed that the prices of selling electricity to and buying it from the main distribution grid are different. In addition, the prices are different from that of selling electricity to customers. In this case, the maximum total profit in a 24 hour period is \$2322.98.

Predicted electric load in case 2:



Price of exchanging electricity with the main distribution grid:

Electric price selling to main distributed grid (\$/kWh)

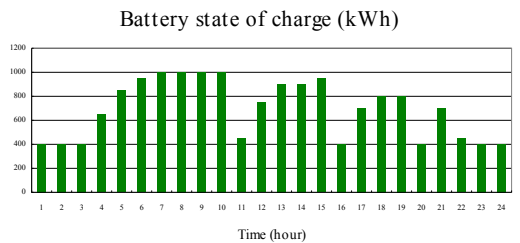
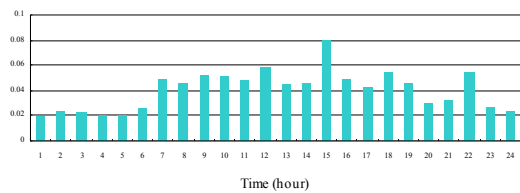

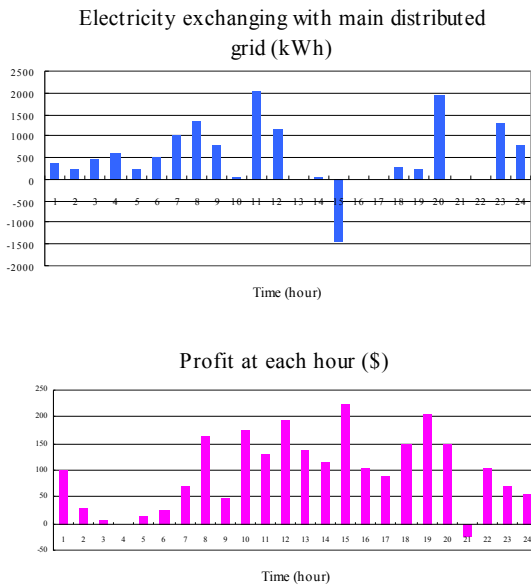

Fig. 9. The results of simulation in case 2.

The optimal operation in case 2 is totally different from case 1 due to the availability of interconnection with the main distribution grid. When the price of buying electricity from the main grid is low, the MGO operates the MG with a SRMC equal to the main grid price. The deficiency in generating will be fulfilled by buying electricity from main distribution grid. Inversely, when the price of selling electricity is high, the MGO increases production to supply a load, as well as to sell to the main distribution grid to maximize profit. That is also the reason why expensive sources (FCs) are only operated for a few hours.

8. Conclusions

This paper has introduced a new DP formulation that can be applied to MGs in a new scenario in which, the DGs and the storage devices are used. The highlights of the paper deal with the constraint of turning on/off of DGs: minimum up time, minimum down time and at the same time, the use of batteries in order to reduce the SRMC. From the system operator's point of view, a DR program is similar to creating more backup electricity sources. However, from demand side, it can be widely implemented in the near future when the technology

barriers are overcome. We will leave that to future studies.

Acknowledgment

This work was supported by the Korea Electric Power Research Institute (KEPRI) as a part of its research into the Development of Energy Management Systems for Microgrids.

References

- [1] Research report International, "Understanding the Microgrids," 2007.
- [2] Eric Allen and Marija Ilic, "Price-Based Commitment Decisions in the Electricity Market," Springer, 2006.
- [3] Felix A. Farret, M. Godoy Simoes, "Integration of Alternative Sources of Energy," IEEE Press, A John Wiley & Sons, Inc., Publication.
- [4] Antonis G. Tsikalakis, Nikos D. Hatziaargyriou, "Centralized Control for Optimizing Microgrids Operation," *IEEE Transactions on Energy Conversion*, Vol. 23, March 2008.
- [5] T. Logenthiran, Dipti Srinivasan, "Multi-Agent Coordination for DER in Microgrid," IEEE 2008.
- [6] Luis M. Costa, George Kariniotakis, "A Stochastic Dynamic Programming Model for Optimal Use of Local Resources in Market Environment," IEEE 2007.
- [7] Chin-Woo Tan, Pravin Varaiya, "Interruptible Electric Power Service Contracts," *Journal of Economic Dynamics and Control* 17, 1993.
- [8] H.A. Aalami, M. Parsa Moghaddam, G.R. Yousefi, "Demand Response Modeling Considering Interruptible/Curtailable Loads and Capacity Market Program," *Appl Energy*, 2009.
- [9] C.W. Yu, S.H. Zhang, L. Wang, T.S. Chung, "Analysis of Interruptible Electric Power in Deregulated Power Systems," *Electric Power Systems Research* 77, 2007.
- [10] Benjamin F. Hobbs, Michael H. Rothkopf, Richard P. O'Neill, Hung-po Chao, "The next Generation of Electric Power Unit Commitment Models," Kluwer Academic Publisher, Boston/Dordrecht/London, 2001.
- [11] Dimitri P. Bertsekas, "Dynamic Programming and Optimal Control," Vol. I, Athena Scientific, Belmont, Massachusetts.
- [12] National Renewable Energy Laboratory, "HOMER- The Optimization Model for Distributed Power."



Minh Y Nguyen was born in Thainguyen province, Vietnam in 1983. He received a B.S degree from the Hanoi University of Technology, Vietnam in 2006. Currently, he is a master's candidate in the Dept. of Electrical Engineering and Computer Science, Seoul National University, Korea. His main research interests include the optimization and planning of power systems, including microgrids, renewable energy and distributed generation.



Nack-Hyun Choi was born in Seoul, Korea in 1983. He received a B.S.E.E. degree from Ajou University, Suwon, Korea in 2008. Currently he is a master's candidate in the Department of Electrical Engineering at Seoul National University. His present research interests are the design of distribution systems with distributed generators and optimal microgrid design.



Yong-Tae Yoon was born in Korea in 1971. He received a B.S., a M.Eng. and a Ph.D. from the Massachusetts Institute of Technology, Cambridge, in 1995, 1997 and 2001, respectively. Currently, he is an Associate Professor in the School of Electrical Engineering and Computer Science, Seoul National University, Korea. His main research interests include electric power network economics, power systems reliability and the incentive regulation of independent transmission companies.