

Throughput-Reliability Tradeoff in Decode-and-Forward Cooperative Relay Channels: A Network Information Theory Approach

Jun Li and Wen Chen

Abstract: Cooperative transmission protocols are always designed to achieve the largest diversity gain and the network capacity simultaneously. The concept of diversity-multiplexing tradeoff (DMT) in multiple input multiple output (MIMO) systems has been extended to this field. However, DMT constrains a better understanding of the asymptotic interplay between transmission rate, outage probability (OP) and signal-to-noise ratio. Another formulation called the throughput-reliability tradeoff (TRT) was then proposed to avoid such a limitation. By this new rule, Azarian and Gamal well elucidated the asymptotic trends exhibited by the OP curves in block-fading MIMO channels. Meanwhile they doubted whether the new rule can be used in more general channels and protocols. In this paper, we will prove that it does hold true in decode-and-forward cooperative protocols. We deduce the theoretic OP curves predicted by TRT and demonstrate by simulations that the OP curves will asymptotically overlap with the theoretic curves predicted by TRT.

Index Terms: Cooperative communications, decode-and-forward (DF), diversity-multiplexing tradeoff (DMT), network information theory, throughput-reliability tradeoff (TRT).

I. INTRODUCTION

Recently, there has been a growing interest in the design and analysis of protocols in cooperative transmission systems [1]–[12]. Such a system can be viewed as a derivative form of multiple input multiple output (MIMO) system. On the other hand, network information theory has been studied for almost three decades, which focus on the achievable rates and capacity region in various network channels [8], [13]–[17], such as relay channels, broadcast channels and so on. Thus, from a new perspective of combining MIMO with network information theory, a good cooperative transmission protocol should pay attention to not only the diversity gain but also the network capacity.

In [18], Zheng and Tse raise a formulation between the diversity gain and multiplexing gain in MIMO systems, which is called diversity-multiplexing tradeoff (DMT). In DMT, diversity gain d and multiplexing gain r are defined by

$$d \triangleq - \lim_{\rho \rightarrow \infty} \frac{\log(P_o(\rho))}{\log \rho} \quad \text{and} \quad r \triangleq \lim_{\rho \rightarrow \infty} \frac{R(\rho)}{\log \rho}, \quad (1)$$

Manuscript received February 22, 2008; approved for publication by Saeed S. Ghassemzadeh, Division I Editor, April 03, 2009.

This work is supported by NSF China #60972031, #60672067, and #60632040, by Cultivation Fund of the Key Scientific and Technical Innovation Project, Ministry of Education of China #706022, by Program for New Century Excellent Talents in University #NCET-06-0386, by PUJIANG Rencai #07PJ4046, and by Huawei funding #YJCB2008048WL.

The authors are with the Department of Electronic Engineering, Shanghai Jiaotong University, Shanghai, 200240 PRC. email: {jleesr80, wenchen}@sjtu.edu.cn.

where ρ , $P_o(\rho)$, and $R(\rho)$ represent the signal-to-noise ratio (SNR), outage probability (OP), and transmission rate respectively. So a scheme's DMT means that at the r multiplexing gain, the diversity gain that the scheme acquires should not exceed $d(r)$. Now, this formulation is successfully used as a rule in cooperative communications to evaluate the performance of different cooperative transmission protocols [9]–[12].

However, the limitation of DMT imposed by the concept of multiplexing gain leads to a malfunction in predicting the OP curves [19] due to

$$\limsup_{\rho \rightarrow \infty} \frac{R}{\log \rho} \neq \liminf_{\rho \rightarrow \infty} \frac{R}{\log \rho}. \quad (2)$$

Then, another two improved methods are put forward. One is raised by Narasimhan [20] who focuses on the finite-SNR diversity-multiplexing tradeoffs. He proposes the outage probability curves in correlated Rayleigh and Rician MIMO channels by using nonlinear programming on the condition that SNR is finite. New definition of diversity gain and multiplexing gain are also given in [20],

$$d \triangleq - \frac{\partial \ln P_o(\rho)}{\partial \ln \rho} \quad \text{and} \quad r \triangleq \frac{R}{\log_2(1 + \rho)}. \quad (3)$$

Thus, the diversity gain defined at finite SNR is the slope of the $\log P_o$ vs $\log \rho$ curves. This method has been extended to cooperative relay channels [21] where one source, one relay and one destination are taken into account. Since the nonlinear programming is used to work out the P_o , the process of computation is time-consuming, especially in large networks.

The other improvement is proposed by Azarian and El Gamal [19]. They deduce a relationship between the three quantities $\{R, \log \rho, P_o(R, \rho)\}$, which is called throughput-reliability tradeoff (TRT) [19]. From the simulations, we can see that TRT predicts the OP curves by using the linear approximation method, which implies that it is less computational than the first method. In [19], the authors posed the following open problem: "For MIMO channels, we established the correspondence between DMT and TRT formulations. It remains to see if such a correspondence exists for general channels or not." This motivates us to have a in-depth investigation on the TRT formulation in cooperative communications.

Since the TRT analysis has been well studied in amplify-and-forward (AF) protocol [22], [23], in this paper, we consider a special decode-and-forward (DF) cooperative protocol, in which relays are supposed to jointly decode the signals transmitted by the source and retransmit them to the destination. To deduce the TRT in DF protocols, we first setup a slotted DF cooperative

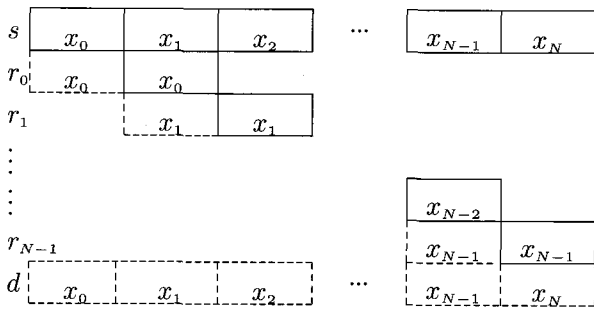

Fig. 1. Frame structure and scheduling scheme in SSDF protocol.

systems with one source, one destination and N relays, where a frame is divided into some sub-frames and each relay help source to transmits the sub-frames by the round-robin way [11]. In this paper, relays are assumed to be connected by a wired network. So each relay can get the decoding information from the other relays, and then can execute the joint decoding algorithm on the received signals from the source.

The scheduling scheme is shown as Fig. 1. Note that dashed boxes in Fig. 1 mean the receiving procedures while the solid ones mean transmitting procedures. In Fig. 1, x_j ($j \in \{0, \dots, N-1\}$) is the sub-frame transmitted by the j th relay r_j . Since joint decoding is applied to relays, each sub-frame can be supposed to contain only one symbol without loss of generality. If frame length $l > N$, the remained $(l - N)$ symbols should be transmitted by the relays in the next round with the same order. Then, we get symbol based SDF protocol (SSDF). We will base our works on the SSDF protocol.

The goal of our works is to follow the TRT concept in MIMO systems and apply such a concept to DF cooperative systems. Our contributions is to prove that the concept of TRT can hold true in DF cooperative systems and deducing the TRT formulation of SSDF cooperative systems to reveal the asymptotic trends exhibited by outage probability.

The notations used in this paper go as follows. $(x)^+$ denotes $\max\{0, x\}$, $(x)^-$ denotes $\min\{0, x\}$, \mathbb{R}^N and \mathbb{C}^N means the set of real and complex N -tuples, and \mathbb{R}^{N+} denotes the set of non-negative N -tuples. If some set $\mathbf{O} \subseteq \mathbb{R}^N$, we denote the complete set of \mathbf{O} as \mathbf{O}^c , while $\mathbf{O} \cap \mathbb{R}^{N+}$ as \mathbf{O}^+ . $\mathbf{\Lambda}_x$ denotes the auto-covariance matrix of vector x .

II. SYSTEM MODEL AND PRELIMINARIES

In this section, we will introduce the system model and prove a lemma that will be used in the sequel.

A. System Model

Fig. 2 shows the channels model in SSDF. All channels are assumed to be flat Rayleigh-fading and quasi-static in at least one frame period, all nodes are in half-duplexing mode, and all noises observed by the relays and destination are Gaussian distributed. We use g_j , \bar{h} , and h_j to denote the channels between the source and the j th relay, the source and the destination, the j th relay and the destination respectively (see Fig. 2), which are all Rayleigh distributed with zero means and variances $\sigma_{g_j}^2$, $\sigma_{\bar{h}}^2$, and

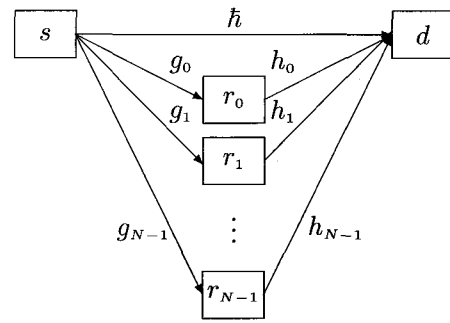

Fig. 2. Cooperative channels with N isolated relays.

$\sigma_{h_j}^2$, respectively while each relay is assumed to be isolated from the other relays. We take $\sigma_{g_j}^2 = \sigma_{\bar{h}}^2 = \sigma_{h_j}^2 = 1$ in the numerical examples. All noises observed by the relays and destination have zero means and variances $\sigma_{r_j}^2$ ($j = 0, 1, 2, \dots, N-1$) and σ_d^2 respectively. We assume that $\sigma_{r_j}^2 = \sigma_d^2 = \sigma^2$. Similar to the power allocation in [21], we denote P as the average total network transmission power over a symbol time slot, that is,

$$E \left\{ \frac{1}{l} \sum_{i=0}^{l-1} |x_{s,i}|^2 \right\} = \kappa P$$

$$E \left\{ \frac{1}{l} \sum_{i=0}^{l-1} |x_{r_j,i}|^2 \right\} = \tau_j P \quad (j = 0, 1, 2, \dots, N-1) \quad (4)$$

$$\kappa + \sum_{j=0}^{N-1} \tau_j = 1 \quad \text{and} \quad \kappa, \tau_0, \dots, \tau_{N-1} \geq 0$$

where $x_{s,i}$ represents the i th symbol in a frame transmitted by the source, and $x_{r_j,i}$ represents the i th symbol in a frame transmitted by the j -th relay. Based on the power constraints in (4), we define the network SNR as $\rho \triangleq P/\sigma^2$. By applying these definitions, we then give some theoretic results.

B. Preliminaries

We will summarize several expressions and results that will be used later. We denote that as $\rho \rightarrow \infty$, $f(\rho) \doteq \rho^a$ if function $f(\rho)$ is exponentially equal to ρ^a , that is, $\lim_{\rho \rightarrow \infty} \log f(\rho) / \log \rho = a$. Since the probability density function (PDF) of $|k_{i,j}|^2$ is $\exp(-|k_{i,j}|^2)$ where $k_{i,j}$ is the coefficient of Rayleigh-fading channel between nodes i and j , we then introduce the variable

$$\eta_{i,j} = \frac{\log(1 + \rho |k_{i,j}|^2)}{R}. \quad (5)$$

Thus, the PDF of $\eta_{i,j}$ can be expressed as

$$p(\eta_{i,j}) = \frac{K}{\rho} \exp\left(-\frac{2^{\eta_{i,j}R} - 1}{\rho}\right) 2^{\eta_{i,j}R} \quad (6)$$

where $K = R \ln 2$ is a constant to $\eta_{i,j}$. We will use (6) to deduce the joint PDF of SSDF channels in the Section IV.

In SSDF protocol with N relays and l -symbol per frame, the mutual information between two sets $\{s, r_1, \dots, r_N\}$ and $\{d\}$

during a frame period is

$$I = \log(1 + \kappa\rho|\bar{h}|^2) + \sum_{i=0}^{l-2} \log\left(1 + \kappa\rho|\bar{h}|^2 + \frac{l\tau_{i_N}}{M_{i_N}}\rho|h_{i_N}|^2\right) \quad (7)$$

where i_N denotes $(i \bmod N)$. M_{i_N} is the number of time slots the i_N th relay is used during a frame period and $\sum_{i=0}^{l-2} M_{i_N} = l - 1$. Thus, we have the following lemma.

Lemma 1: when $\rho \rightarrow \infty$, two bounds of equation (7) are

$$\begin{aligned} I &\geq \log\left(1 + \frac{l\rho}{2l-1}|\bar{h}|^2\right) \\ &\quad + \log\left(\left(1 + \frac{l\rho}{2l-1}|\bar{h}|^2\right)^{l-1} + \prod_{i=0}^{l-2} \left(1 + \frac{l\rho}{2l-1}|h_{i_N}|^2\right)\right) \\ I &\leq \log(1 + \rho|\bar{h}|^2) \\ &\quad + \log\left((1 + \rho|\bar{h}|^2)^{l-1} + \prod_{i=0}^{l-2} (1 + \rho|h_{i_N}|^2)\right). \end{aligned} \quad (8)$$

Proof: We turn to the lower bound of (7) at first. Because of the channel power control, the whole energy to transmit per frame is lP . The least mutual information is acquired on the condition that the energy is equally distributed to each channel use. During a frame period, l symbols are transmitted by source, and M_{i_N} symbols are transmitted by each relay. Let $\kappa = l/(2l-1)$ and $\tau_{i_N} = M_{i_N}/(2l-1)$, we get

$$\begin{aligned} I_1 &= \log\left(1 + \frac{l\rho}{2l-1}|\bar{h}|^2\right) \\ &\quad + \sum_{i=0}^{l-2} \log\left(1 + \frac{l\rho}{2l-1}|\bar{h}|^2 + \frac{l\rho}{2l-1}|h_{i_N}|^2\right). \end{aligned} \quad (9)$$

According to the convex analysis theory,

$$\begin{aligned} &\prod_{i=0}^{l-2} \left(1 + \frac{l\rho}{2l-1}|\bar{h}|^2 + \frac{l\rho}{2l-1}|h_{i_N}|^2\right) \\ &\geq \left(1 + \frac{l\rho}{2l-1}|\bar{h}|^2 + \left(\prod_{i=0}^{l-2} \frac{l\rho}{2l-1}|h_{i_N}|^2\right)^{\frac{1}{l-1}}\right)^{l-1} \\ &\geq \left(1 + \frac{l\rho}{2l-1}|\bar{h}|^2\right)^{l-1} + \prod_{i=0}^{l-2} \left(1 + \frac{l\rho}{2l-1}|h_{i_N}|^2\right). \end{aligned} \quad (10)$$

So I_1 in (9) has a lower bound as

$$\begin{aligned} I_1 &\geq \log\left(1 + \frac{l\rho}{2l-1}|\bar{h}|^2\right) + \\ &\quad \log\left(\left(1 + \frac{l\rho}{2l-1}|\bar{h}|^2\right)^{l-1} + \prod_{i=0}^{l-2} \left(1 + \frac{l\rho}{2l-1}|h_{i_N}|^2\right)\right). \end{aligned} \quad (11)$$

On the other hand, let $\kappa = 1$ and $\tau_{i_N} = (l-1)/Nl$. Then we can get an upper bound of (7), that is,

$$I_2 = \log(1 + \rho|\bar{h}|^2) + \sum_{i=0}^{l-2} \log(1 + \rho|\bar{h}|^2 + \rho|h_{i_N}|^2). \quad (12)$$

By the C_p inequality,

$$\begin{aligned} &\prod_{i=0}^{l-2} (1 + \rho|\bar{h}|^2 + \rho|h_{i_N}|^2) \\ &\leq 2^{l-2} \left((1 + \rho|\bar{h}|^2)^{l-1} + \left(\rho \max_i \{h_{i_N}\}^2\right)^{l-1} \right) \\ &\doteq (1 + \rho|\bar{h}|^2)^{l-1} + \left(1 + \rho \max_i \{h_{i_N}\}^2\right)^{l-1} \\ &\doteq (1 + \rho|\bar{h}|^2)^{l-1} + \prod_{i=0}^{l-2} (1 + \rho|h_{i_N}|^2). \end{aligned} \quad (13)$$

So I_2 in (12) has an upper bound as

$$\begin{aligned} I_2 &\leq \log(1 + \rho|\bar{h}|^2) \\ &\quad + \log\left((1 + \rho|\bar{h}|^2)^{l-1} + \prod_{i=0}^{l-2} (1 + \rho|h_{i_N}|^2)\right). \end{aligned} \quad (14)$$

Then, mutual information I in (7) under the power constraints (4) has the relationship as $I_1 \leq I \leq I_2$. So proof is complete. \square

III. OUTAGE REGIONS IN SSDF PROTOCOL

Since network information theory only focuses on the information flow in a network, and it does not care the scheduling scheme and node's physical constraints, in SSDF protocol with joint decoding algorithm at relays, according to the round-robin scheduling scheme, we can take the N relays as a virtual relay (VR) with one receiver and one transmitter. VR can receive and transmit signals simultaneously, i.e., VR is full-duplexing. The $s \rightarrow r$ and $r \rightarrow d$ channels are changing in every time slots while $s \rightarrow d$ channel only changes from one frame to the next. Thus, the conclusion in [17] can be applied to SSDF protocol, i.e.,

$$I_{\max} \leq \max\{\min\{I(X_s; Y_r), I(X_s, X_r; Y_d)\}, I(X_s; Y_d)\} \quad (15)$$

where X denotes the transmitted signals in each node, and Y denotes the received signals in each node. Since joint decoding is applied to relays (they are connected by a wired network), each relay can inerrably get the decoding information of the other relays. So the achievability of equation (15) can be proven by using the Block-Markov encoding at source and the successive cancellation decoding at relays [17].

In the non-ergodic fading channels, performance of the connection is evaluated in terms of outage probability, which is defined as the event that the instantaneous mutual information does not support the intended rate [24], i.e., $\mathbf{O}_p \triangleq \{\mathbf{H} | I(x; y | \mathbf{H}) = \mathbf{H} < R\}$, where \mathbf{H} is a channel realization. The lower bound of \mathbf{O}_p 's probability is defined as outage probability $P_o(R, \rho)$.

Then, $P_o(R, \rho) = \Pr\left\{\max_{\mathbf{A}_x} I(x; y | \mathbf{H}) < R\right\}$. So under some channel realization \mathbf{H} , there are three outage events according to (15),

$$E_{s;r} : I(X_s; Y_r | \mathbf{H}) = \sum_{i=0}^{l-2} \log(1 + \kappa\rho|g_{i_N}|^2) < lR,$$

$$E_{s,r;d} : I(X_s, X_r; Y_d | \mathbf{H}) = \log(1 + \kappa\rho|\tilde{h}|^2) + \sum_{i=0}^{l-2} \log \left(1 + \kappa\rho|\tilde{h}|^2 + \frac{l\tau_{iN}}{M_{iN}}\rho|h_{iN}|^2 \right) < lR,$$

$$E_{s;d} : I(X_s; Y_d | \mathbf{H}) = \log(1 + \kappa\rho|\tilde{h}|^2) < R.$$

Then from (15), we conclude that the outage event of the whole network with SSDF protocol is

$$E_o : \max\{\min\{I(X_s; Y_r | \mathbf{H}), I(X_s, X_r; Y_d | \mathbf{H})\}, I(X_s; Y_d | \mathbf{H})\} < lR, \quad (16)$$

that is, $E_o = (E_{s;r} \cup E_{s,r;d}) \cap E_{s;d}$. From (16), we notice that $E_{s;r}$ is irrelevant with $E_{s,r;d}$ and $E_{s;d}$, and $E_{s,r;d} \subseteq E_{s;d}$. So

$$\begin{aligned} P(E_o) &= P((E_{s;r} \cup E_{s,r;d}) \cap E_{s;d}) \\ &= P((E_{s;r} \cap E_{s;d}) \cup E_{s,r;d}) \\ &= P(E_{s;r})P(E_{s;d}) + P(E_{s,r;d}) - P(E_{s;r})P(E_{s,r;d}) \\ &= P(E_{s;r})(P(E_{s;d}) - P(E_{s,r;d})) + P(E_{s,r;d}). \end{aligned} \quad (17)$$

(17) shows that $P(E_o)$ is an increasing function of $P(E_{s;r})$, $P(E_{s,r;d})$ and $P(E_{s;d})$. According to Lemma 1, when $\rho \rightarrow \infty$, the lower bounds of the three probability values are respectively

$$\begin{aligned} P(E_{s;r}) &\geq \Pr \left\{ \sum_{i=0}^{l-2} \log(1 + \rho|g_{iN}|^2) < lR \right\}, \\ P(E_{s,r;d}) &\geq \Pr \left\{ \max \left\{ \log(1 + \rho|\tilde{h}|^2)^l, \right. \right. \\ &\quad \left. \left. \log(1 + \rho|\tilde{h}|^2) + \sum_{i=0}^{l-2} (1 + \rho|h_{iN}|^2) \right\} < lR \right\}, \\ P(E_{s;d}) &\geq \Pr \left\{ \log(1 + \rho|\tilde{h}|^2) < R \right\}, \end{aligned} \quad (18)$$

and the upper bounds are respectively

$$\begin{aligned} P(E_{s;r}) &\leq \Pr \left\{ \sum_{i=0}^{l-2} \log \left(1 + \frac{l\rho}{2l-1} |g_{iN}|^2 \right) < lR \right\}, \\ P(E_{s,r;d}) &\leq \Pr \left\{ \max \left\{ \log \left(1 + \frac{l\rho}{2l-1} |\tilde{h}|^2 \right)^l, \right. \right. \\ &\quad \left. \left. \log \left(1 + \frac{l\rho}{2l-1} |\tilde{h}|^2 \right) + \sum_{i=0}^{l-2} \left(1 + \frac{l\rho}{2l-1} |h_{iN}|^2 \right) \right\} < lR \right\}, \\ P(E_{s;d}) &\leq \Pr \left\{ \log \left(1 + \frac{l\rho}{2l-1} |\tilde{h}|^2 \right) < R \right\}. \end{aligned} \quad (19)$$

We define another outage event $E_{r;d}$, which satisfies that $E_{s,r;d} = E_{s;d} \cap E_{r;d}$. From (18) and (19), we get the lower bound of $P(E_{r;d})$, that is,

$$P(E_{r;d}) \geq \Pr \left\{ \log(1 + \rho|\tilde{h}|^2) + \sum_{i=0}^{l-2} (1 + \rho|h_{iN}|^2) < lR \right\}, \quad (20)$$

and the upper bound

$$P(E_{r;d}) \leq \Pr \left\{ \log \left(1 + \frac{l\rho}{2l-1} |\tilde{h}|^2 \right) + \sum_{i=0}^{l-2} \left(1 + \frac{l\rho}{2l-1} |h_{iN}|^2 \right) < lR \right\}. \quad (21)$$

So we rewrite the network outage probability of (17) as

$$P_o = P(E_o) = P((E_{s;r} \cup E_{s,r;d}) \cap E_{s;d}). \quad (22)$$

Based on these conclusions, we then make a more detailed TRT analysis on the SSDF protocols.

IV. THROUGHPUT-RELIABILITY TRADEOFF ANALYSIS

The asymptotic relationship of R , ρ , and $P_o(R, \rho)$ has been well deduced in MIMO channels [19]. Our work proves that such relationship also holds true in SSDF protocol.

Theorem 1: For the one source, one destination and N relays SSDF block-fading cooperative channels with l ($l \geq N+1$) symbols per frame, there are k ($N \geq k \geq 0$, $k \in \mathbb{Z}$) operating regions, in which

$$\lim_{\substack{\rho \rightarrow \infty \\ (R, \rho) \in \mathbf{R}(k)}} \frac{\log P_o(R, \rho) - c(k)R}{\log \rho} = -g(k) \quad (23)$$

where $\mathbf{R}(k)$ means the k th operating region, $g(k)$ is referred to the reliability gain coefficient and $g(k)/c(k)$ is referred to the throughput gain coefficient.

Consider two cases, $(l-1)_N = 0$ and $(l-1)_N \neq 0$.

Case 1: $(l-1)_N = 0$

The k regions can be combined to two super operating regions, i.e.,

$$\begin{aligned} \mathbf{R}(k) &\triangleq \begin{cases} \left\{ (R, \rho) \mid \frac{(l-1)(k+1)}{lN} > \frac{R}{\log \rho} > \frac{(l-1)k}{lN} \right\}, & N > k \geq 0, \\ \left\{ (R, \rho) \mid 1 > \frac{R}{\log \rho} > \frac{l-1}{l} \right\}, & k = N, \end{cases} \end{aligned} \quad (24)$$

and $\{c(k), g(k)\}$ are defined according to $\mathbf{R}(k)$,

$$\{c(k), g(k)\} \triangleq \begin{cases} \left\{ 1 + \frac{lN}{l-1}, 1 + N \right\}, & N > k \geq 0, \\ \{1, 1\}, & k = N. \end{cases} \quad (25)$$

Case 2: $(l-1)_N = m$ ($0 < m < N$)

There are two extreme cases to give the outage probability bounds, i.e., the remaining m symbols are transferred through the best m relay channels and the worst m relay channels. They give the two bounds of the outage probability curves. When the best m source-relay channels are first used (BCFU), there are three super regions:

$$\begin{aligned} \mathbf{R}_1(k) &\triangleq \begin{cases} \left\{ (R, \rho) \mid \frac{(l-1+N-m)(k+1)}{lN} > \frac{R}{\log \rho} > \frac{(l-1+N-m)k}{lN} \right\}, & m > k \geq 0, \\ \left\{ (R, \rho) \mid \frac{(l-1-m)(k+1)+mN}{lN} > \frac{R}{\log \rho} > \frac{(l-1-m)k+mN}{lN} \right\}, & N > k \geq m, \\ \left\{ (R, \rho) \mid 1 > \frac{R}{\log \rho} > \frac{l-1}{l} \right\}, & k = N, \end{cases} \end{aligned} \quad (26)$$

and $\{c_1(k), g_1(k)\}$ are defined according to $\mathbf{R}_1(k)$, that is,

$$\{c_1(k), g_1(k)\} \triangleq \begin{cases} \left\{1 + \frac{lN}{l-1+N-m}, 1 + N\right\}, & m > k \geq 0, \\ \left\{1 + \frac{lN}{l-1-m}, 1 + \frac{(l-1)N}{l-1-m}\right\}, & N > k \geq m, \\ \{1, 1\}, & k = N. \end{cases} \quad (27)$$

When the worst m channels are first used (WCFU),

$\mathbf{R}_2(k)$

$$\triangleq \begin{cases} \left\{ \begin{aligned} & \left\{ (R, \rho) \mid \frac{(l-1-m)(k+1)}{lN} > \frac{R}{\log \rho} > \frac{(l-1-m)k}{lN} \right\}, & N-m > k \geq 0, \\ & \left\{ (R, \rho) \mid \frac{(l-1+N-m)(k+1)+mN-N^2}{lN} > \frac{R}{\log \rho} > \frac{(l-1+N-m)k+mN-N^2}{lN} \right\}, & N > k \geq N-m, \\ & \left\{ (R, \rho) \mid 1 > \frac{R}{\log \rho} > \frac{l-1}{l} \right\}, & k = N, \end{aligned} \right. \end{cases} \quad (28)$$

and $\{c_2(k), g_2(k)\}$ are defined according to $\mathbf{R}_2(k)$, that is,

$$\{c_2(k), g_2(k)\} \triangleq \begin{cases} \left\{1 + \frac{lN}{l-1-m}, 1 + N\right\}, & N-m > k \geq 0, \\ \left\{1 + \frac{lN}{l-1+N-m}, 1 + \frac{(l-1)N}{l-1+N-m}\right\}, & N > k \geq N-m, \\ \{1, 1\}, & k = N. \end{cases} \quad (29)$$

Proof: Note that all the variables have the same sense as defined in [19]. The proof also follows the same lines that of Lemma 2 in [19]. To get the proof, we should first find the lower bound and upper bound of $\log P_o(R, \rho)$, i.e.,

$$\begin{aligned} & \liminf_{\substack{\rho \rightarrow \infty \\ (R, \rho) \in \mathbf{R}(k)}} \frac{\log P_o(R, \rho) - c(k)R}{\log \rho}, \\ & \limsup_{\substack{\rho \rightarrow \infty \\ (R, \rho) \in \mathbf{R}(k)}} \frac{\log P_o(R, \rho) - c(k)R}{\log \rho}. \end{aligned} \quad (30)$$

Then, we use the inequalities of (18) and (19) to derive the two bounds of (30).

A. Lower Bound

Based on the channels model of SSDF protocol, we redefine the variables introduced by equations (5). For the direct channel, $\bar{\beta} \triangleq \log(1 + \rho|h|^2)/R$, and for the relay channels, $\alpha_j \triangleq \log(1 + \rho|g_j|^2)/R$ and $\beta_j \triangleq \log(1 + \rho|h_j|^2)/R$, where $j = 0, 1, 2, \dots, N-1$. Then let us focus on the inequalities in (18), we get the outage region

$$\mathbf{O}_l \triangleq \{\bar{\beta} \in \mathbb{R}^+, \alpha \in \mathbb{R}^{N+}, \beta \in \mathbb{R}^{N+}, \bar{\beta} < 1, \min \left\{ \frac{1}{l} \sum_{i=0}^{l-2} \alpha_{i_N}, \frac{1}{l} \left(\bar{\beta} + \sum_{i=0}^{l-2} \beta_{i_N} \right) \right\} < 1\} \quad (31)$$

where $\alpha = [\alpha_0, \alpha_1, \dots, \alpha_{N-1}]$, $\beta = [\beta_0, \beta_1, \dots, \beta_{N-1}]$.

According to (6), the joint PDF of vector $(\bar{\beta}, \alpha, \beta)$ is

$$\begin{aligned} p(\bar{\beta}, \alpha, \beta) &= p(\bar{\beta})p(\alpha_0) \cdots p(\alpha_{N-1})p(\beta_0) \cdots p(\beta_{N-1}) \\ &= \left(\frac{K}{\rho}\right)^{2N+1} 2^{\bar{\beta}R} 2^{\sum_{i=0}^{N-1} (\alpha_i + \beta_i)R} \times \\ &\quad \exp \left\{ -\frac{2^{\bar{\beta}R} - 1}{\rho} - \sum_{i=0}^{N-1} \frac{2^{\alpha_i R} - 1 + 2^{\beta_i R} - 1}{\rho} \right\}. \end{aligned} \quad (32)$$

By defining $f(\bar{\beta}, \alpha, \beta) \triangleq \bar{\beta} + \sum_{i=0}^{N-1} (\alpha_i + \beta_i)$, we can give the more compact form of the joint PDF,

$$\begin{aligned} p(\bar{\beta}, \alpha, \beta) &= K^{2N+1} e^{\frac{2N+1}{\rho}} \rho^{-(2N+1)} 2^{f(\bar{\beta}, \alpha, \beta)R} \\ &\quad \times \exp \left\{ -\frac{2^{\bar{\beta}R}}{\rho} - \sum_{i=0}^{N-1} \frac{2^{\alpha_i R} + 2^{\beta_i R}}{\rho} \right\}. \end{aligned} \quad (33)$$

It follows that

$$P_o(R, \rho) 2^{-c(k)R} \geq 2^{-c(k)R} \iiint_{\mathbf{O}_l} p(\bar{\beta}, \alpha, \beta) d\bar{\beta} d\alpha d\beta. \quad (34)$$

Search the subset $\mathbf{O}_{l, \epsilon_0} \subset \mathbf{O}_l$, that is,

$$\begin{aligned} \mathbf{O}_{l, \epsilon_0} &\triangleq \left\{ (\bar{\beta}, \alpha, \beta) \in \mathbf{O}_l \mid \exists \epsilon_0 > 0, \text{ s.t.} \right. \\ &\quad \left. \frac{\log \rho}{R} - \epsilon_0 \geq \max\{\bar{\beta}, \alpha_{\max}, \beta_{\max}\} \right\} \end{aligned} \quad (35)$$

where $\alpha_{\max} = \max\{\alpha_0, \dots, \alpha_{N-1}\}$ and $\beta_{\max} = \max\{\beta_0, \dots, \beta_{N-1}\}$. So (34) yields

$$\begin{aligned} P_o(R, \rho) 2^{-c(k)R} &\geq K^{2N+1} e^{\frac{2N+1}{\rho} - (2N+1)2^{-\epsilon_0 R}} \rho^{-(2N+1)} \times \\ &\quad 2^{-c(k)R} \iiint_{\mathbf{O}_{l, \epsilon_0}} 2^{f(\bar{\beta}, \alpha, \beta)R} d\bar{\beta} d\alpha d\beta. \end{aligned} \quad (36)$$

We define $\zeta_{\epsilon_0} \triangleq \arg \sup_{(\bar{\beta}, \alpha, \beta) \in \mathbf{O}_{l, \epsilon_0}} f(\bar{\beta}, \alpha, \beta)$. Because of the continuity of f , for some $\epsilon_1 > 0$, there must exist a ζ_{ϵ_0} 's neighborhood $I_{\epsilon_1} \subset \mathbf{O}_l$, in which $f(\bar{\beta}, \alpha, \beta) \geq f(\zeta_{\epsilon_0}) - \epsilon_1$. So in the intersection $\mathbf{O}_{l, \epsilon_0} \cap I_{\epsilon_1}$,

$$\begin{aligned} P_o(R, \rho) 2^{-c(k)R} &\geq K^{2N+1} e^{\frac{2N+1}{\rho} - (2N+1)2^{-\epsilon_0 R}} \rho^{-(2N+1)} \times \\ &\quad 2^{(f(\zeta_{\epsilon_0}) - c(k)R - \epsilon_1)R} \text{Vol}\{\mathbf{O}_{l, \epsilon_0} \cap I_{\epsilon_1}\}, \end{aligned} \quad (37)$$

which means that,

$$\begin{aligned} & \frac{\log P_o(R, \rho) - c(k)R}{\log \rho} \geq \\ & \frac{\log \left(e^{\frac{2N+1}{\rho} - (2N+1)2^{-\epsilon_0 R}} 2^{-\epsilon_1 R} \text{Vol}\{\mathbf{O}_{l, \epsilon_0} \cap I_{\epsilon_1}\} \right)}{\log \rho} + \\ & \frac{\log K^{2N+1} - (2N+1) + (f(\zeta_{\epsilon_0}) - c(k))R}{\log \rho}. \end{aligned} \quad (38)$$

To acquire $f(\zeta_{\epsilon_0})$ under the constraint $\mathbf{O}_{l,\epsilon_0}$, we first split $\mathbf{O}_{l,\epsilon_0}$ of (31) into two nonintersectant subsections, that is,

$$\begin{aligned} \mathbf{O}_{l,\alpha<\beta} &\triangleq \{\bar{\beta} \in \mathbb{R}^+, \alpha \in \mathbb{R}^{N^+}, \beta \in \mathbb{R}^{N^+}, \bar{\beta} < 1, \\ &\sum_{i=0}^{l-2} \alpha_{i_N} < \bar{\beta} + \sum_{i=0}^{l-2} \beta_{i_N}, \frac{1}{l} \sum_{i=0}^{l-2} \alpha_{i_N} < 1\}, \\ \mathbf{O}_{l,\alpha\geq\beta} &\triangleq \{\bar{\beta} \in \mathbb{R}^+, \alpha \in \mathbb{R}^{N^+}, \beta \in \mathbb{R}^{N^+}, \bar{\beta} < 1, \\ &\sum_{i=0}^{l-2} \alpha_{i_N} \geq \bar{\beta} + \sum_{i=0}^{l-2} \beta_{i_N}, \frac{1}{l} \left(\bar{\beta} + \sum_{i=0}^{l-2} \beta_{i_N} \right) < 1\}. \end{aligned} \quad (39)$$

Correspondingly, in the subset $\mathbf{O}_{l,\epsilon_0}$, we have

$$\begin{aligned} \mathbf{O}_{l,\alpha<\beta,\epsilon_0} &\triangleq \{(\bar{\beta}, \alpha, \beta) \in \mathbf{O}_{l,\alpha<\beta} | \exists \epsilon_0 > 0, \text{ s.t.} \\ &\frac{\log \rho}{R} - \epsilon_0 \geq \max\{\bar{\beta}, \alpha_{\max}, \beta_{\max}\}\}, \\ \mathbf{O}_{l,\alpha\geq\beta,\epsilon_0} &\triangleq \{(\bar{\beta}, \alpha, \beta) \in \mathbf{O}_{l,\alpha\geq\beta} | \exists \epsilon_0 > 0, \text{ s.t.} \\ &\frac{\log \rho}{R} - \epsilon_0 \geq \max\{\bar{\beta}, \alpha_{\max}, \beta_{\max}\}\}. \end{aligned} \quad (40)$$

Then,

$$f(\zeta_{\epsilon_0}) = \max \left\{ \sup_{(\bar{\beta}, \alpha, \beta) \in \mathbf{O}_{l,\alpha<\beta,\epsilon_0}} f(\bar{\beta}, \alpha, \beta), \sup_{(\bar{\beta}, \alpha, \beta) \in \mathbf{O}_{l,\alpha\geq\beta,\epsilon_0}} f(\bar{\beta}, \alpha, \beta) \right\}. \quad (41)$$

We partition the operating regions according to the value of $\log \rho / R$. Considering a simple situation where $(l-1)_N = 0$, the operating regions $\mathbf{R}_\delta(k)$ with $k \in \mathbb{Z}$ can be defined as

$$\mathbf{R}_\delta(k) \triangleq \begin{cases} \left\{ (R, \rho) \mid \frac{1}{\delta} > \frac{\log \rho}{R} > \frac{lN}{l-1} + \delta \right\}, & k = 0, \\ \left\{ (R, \rho) \mid \frac{lN}{(l-1)k} - \delta > \frac{\log \rho}{R} > \frac{lN}{(l-1)(k+1)} + \delta \right\}, & N > k > 0, \\ \left\{ (R, \rho) \mid \frac{l}{l-1} - \delta > \frac{\log \rho}{R} > 1 + \delta \right\}, & k = N, \\ \left\{ (R, \rho) \mid 1 - \delta > \frac{\log \rho}{R} > \delta \right\}, & \text{others} \end{cases} \quad (42)$$

where δ is an arbitrary small positive value and $\delta \geq \epsilon_0$.

In the first operating region $\mathbf{R}_\delta(0)$, $\log \rho / R$ is so large that $\bar{\beta}$, α_{\max} , and β_{\max} can not achieve. Otherwise they will be in \mathbf{O}_κ^c . So in subset $\mathbf{O}_{l,\alpha<\beta,\epsilon_0}$, let $\alpha_{\max} = lN/(l-1)$, and let other elements in α be zero. Let all elements in β are equal to $(\log \rho / R - \epsilon_0)$ to achieve the supremum of $f(\bar{\beta}, \alpha, \beta)$. Then,

$$\sup_{(\bar{\beta}, \alpha, \beta) \in \mathbf{O}_{l,\alpha<\beta,\epsilon_0}} f(\bar{\beta}, \alpha, \beta) = 1 + \frac{lN}{l-1} + \left(\frac{\log \rho}{R} - \epsilon_0 \right) N. \quad (43)$$

On the other hand, in the subset $\mathbf{O}_{l,\alpha\geq\beta,\epsilon_0}$, let $\beta_{\max} = N$, and let other elements in β be zero. Let all elements in α be $(\log \rho / R - \epsilon_0)$ to achieve the supremum of $f(\bar{\beta}, \alpha, \beta)$. Then,

$$\sup_{(\bar{\beta}, \alpha, \beta) \in \mathbf{O}_{l,\alpha\geq\beta,\epsilon_0}} f(\bar{\beta}, \alpha, \beta) = 1 + N + \left(\frac{\log \rho}{R} - \epsilon_0 \right) N. \quad (44)$$

According to (41),

$$f(\zeta_{\epsilon_0}) = 1 + \frac{lN}{l-1} + \left(\frac{\log \rho}{R} - \epsilon_0 \right) N. \quad (45)$$

In the operating region $\mathbf{R}_\delta(N)$, $\mathbf{O}_{l,\alpha\geq\beta,\epsilon_0} = \Phi$, and in $\mathbf{O}_{l,\alpha<\beta,\epsilon_0}$, all elements of α and β can reach $(\log \rho / R - \epsilon_0)$ simultaneously while remains the $\bar{\beta} = 1$. Then

$$f(\zeta_{\epsilon_0}) = 1 + 2 \left(\frac{\log \rho}{R} - \epsilon_0 \right) N. \quad (46)$$

For the case $k > N$,

$$f(\zeta_{\epsilon_0}) = \left(\frac{\log \rho}{R} - \epsilon_0 \right) (2N + 1). \quad (47)$$

At last, we focus on $N > k > 1$. To simplify the statement in this situation, we reorder the sequence of elements in α and β by the descendant order, that is, $\alpha_0 \geq \alpha_1 \geq \alpha_2 \geq \alpha_{N-1}$ and $\beta_0 \geq \beta_1 \geq \beta_2 \geq \beta_{N-1}$. Then in the subset $\mathbf{O}_{l,\alpha<\beta,\epsilon_0}$,

$$\alpha = \left(\underbrace{\frac{\log \rho}{R} - \epsilon_0, \dots, \frac{\log \rho}{R} - \epsilon_0}_{k \text{ times}}, \frac{lN}{l-1} - k \left(\frac{\log \rho}{R} - \epsilon_0 \right), 0, \dots, 0 \right), \quad (48)$$

while all elements in β are equal to $(\log \rho / R - \epsilon_0)$ and $\bar{\beta} = 1$. Then,

$$\sup_{(\bar{\beta}, \alpha, \beta) \in \mathbf{O}_{l,\alpha<\beta,\epsilon_0}} f(\bar{\beta}, \alpha, \beta) = 1 + \frac{lN}{l-1} + \left(\frac{\log \rho}{R} - \epsilon_0 \right) N. \quad (49)$$

By following the same way as in subset $\mathbf{O}_{l,\alpha\geq\beta,\epsilon_0}$, we get

$$\sup_{(\bar{\beta}, \alpha, \beta) \in \mathbf{O}_{l,\alpha\geq\beta,\epsilon_0}} f(\bar{\beta}, \alpha, \beta) = 1 + N + \left(\frac{\log \rho}{R} - \epsilon_0 \right) N. \quad (50)$$

So,

$$f(\zeta_{\epsilon_0}) = 1 + \frac{lN}{l-1} + \left(\frac{\log \rho}{R} - \epsilon_0 \right) N. \quad (51)$$

Combine above equations and let δ and ϵ_0 go to 0. Then we get the two super operating regions $\mathbf{R}(k)$ shown as (24). By plugging $f(\zeta_{\epsilon_0})$ into different operating regions, we get

$$\begin{aligned} \liminf_{\substack{\rho \rightarrow \infty \\ (R, \rho) \in \mathbf{R}(N > k \geq 0)}} \frac{\log P_o(R, \rho) - c(k)R}{\log \rho} &\geq -(N + 1) \\ &+ \left(1 + \frac{lN}{l-1} - c(k) \right) \times \liminf_{\substack{\rho \rightarrow \infty \\ (R, \rho) \in \mathbf{R}(N > k \geq 0)}} \frac{R}{\log \rho}, \\ \liminf_{\substack{\rho \rightarrow \infty \\ (R, \rho) \in \mathbf{R}(k = N)}} \frac{\log P_o(R, \rho) - c(k)R}{\log \rho} &\geq -1 \\ &+ (1 - c(k)) \times \liminf_{\substack{\rho \rightarrow \infty \\ (R, \rho) \in \mathbf{R}(k = N)}} \frac{R}{\log \rho}. \end{aligned} \quad (52)$$

B. Upper Bound

We now turn to the second inequality of (19) where we will follow the same expressions and definitions as the priori subsection except for the special announcement.

We introduce the following change of variables, i.e., $\bar{\beta} \triangleq \log(1 + \frac{l}{2l-1}\rho|h|^2)/R$, $\alpha_j \triangleq \log(1 + \frac{l}{2l-1}\rho|g_j|^2)/R$, and $\beta_j \triangleq \log(1 + \frac{l}{2l-1}\rho|h_j|^2)/R$. The outage region is then

$$\mathbf{O}_u \triangleq \{\bar{\beta} \in \mathbb{R}^+, \alpha \in \mathbb{R}^{N+1}, \beta \in \mathbb{R}^{N+1}, \bar{\beta} < 1, \min \left\{ \frac{1}{l} \sum_{i=0}^{l-2} \alpha_{iN}, \frac{1}{l} \left(\bar{\beta} + \sum_{i=0}^{l-2} \beta_{iN} \right) \right\} < 1\}. \quad (53)$$

Split the outage region into two nonintersectant subsets. Then

$$\begin{aligned} \mathbf{O}_{u,-\epsilon_0} &\triangleq \left\{ (\bar{\beta}, \alpha, \beta) \in \mathbf{O}_u \mid \exists \epsilon_0 > 0, \text{ s.t.} \right. \\ &\quad \left. \frac{\log \rho}{R} + \epsilon_0 < \max\{\bar{\beta}, \alpha_{\max}, \beta_{\max}\} \right\}, \\ \mathbf{O}_{u,\epsilon_0} &\triangleq \left\{ (\bar{\beta}, \alpha, \beta) \in \mathbf{O}_u \mid \exists \epsilon_0 > 0, \text{ s.t.} \right. \\ &\quad \left. \frac{\log \rho}{R} + \epsilon_0 \geq \max\{\bar{\beta}, \alpha_{\max}, \beta_{\max}\} \right\}, \end{aligned} \quad (54)$$

We define $f(\bar{\beta}, \alpha, \beta) \triangleq \bar{\beta} + \sum_{i=0}^{N-1} (\alpha_i + \beta_i)$, and let the functions $2^{-c(k)R} \iint p(\bar{\beta}, \alpha, \beta) d\bar{\beta} d\alpha d\beta$ in the two subsets be represented by $O_-(R, \rho)$, $O_+(R, \rho)$, respectively. Then,

$$\frac{\log P_o(R, \rho) - c(k)R}{\log \rho} \leq \frac{\log O_+(R, \rho)}{\log \rho} + \frac{\log \left(1 + \frac{O_-(R, \rho)}{O_+(R, \rho)} \right)}{\log \rho}. \quad (55)$$

In the subset $\mathbf{O}_{u,-\epsilon_0}$, to simplify the expressions, we define another two variables $K_u \triangleq \frac{2l-1}{l}K$ and $e_u \triangleq e^{\frac{2l-1}{l}}$.

$$\begin{aligned} O_-(R, \rho) &\leq K_u^{2N+1} e_u^{\frac{2N+1}{\rho} - 2^{\epsilon_0 R}} \rho^{-(2N+1)} 2^{-c(k)R} \\ &\quad \times \iint_{\mathbf{O}_{u,-\epsilon_0}} 2^{f(\bar{\beta}, \alpha, \beta)R} d\bar{\beta} d\alpha d\beta \\ &\leq K_u^{2N+1} e_u^{\frac{2N+1}{\rho} - 2^{\epsilon_0 R}} \rho^{-(2N+1)} \\ &\quad \times 2^{(f(\zeta_{-\epsilon_0}) - c(k))R} \text{Vol}\{\mathbf{O}_{u,-\epsilon_0}\}, \end{aligned} \quad (56)$$

where $\zeta_{-\epsilon_0} \triangleq \arg \sup_{(\bar{\beta}, \alpha, \beta) \in \mathbf{O}_{u,-\epsilon_0}} f(\bar{\beta}, \alpha, \beta)$. We turn to another two subsets, one is

$$\mathbf{O}_{u,\epsilon_1} \triangleq \left\{ (\bar{\beta}, \alpha, \beta) \in \mathbf{O}_u \mid \exists \epsilon_1 > 0, \text{ s.t.} \right. \\ \left. \frac{\log \rho}{R} - \epsilon_1 \geq \max\{\bar{\beta}, \alpha_{\max}, \beta_{\max}\} \right\}, \quad (57)$$

and the other is ζ_{ϵ_1} 's neighborhood I_{ϵ_2} , where we define $\zeta_{\epsilon_1} \triangleq \arg \sup_{(\bar{\beta}, \alpha, \beta) \in \mathbf{O}_{u,\epsilon_1}} f(\bar{\beta}, \alpha, \beta)$. Because of the continuity of f , for some $\epsilon_2 > 0$, there must exist a ζ_{ϵ_1} 's neighborhood I_{ϵ_2} , in

which $f(\bar{\beta}, \alpha, \beta) \geq f(\zeta_{\epsilon_1}) - \epsilon_2$. We use the conclusion from the priori subsection, i.e.,

$$O_+(R, \rho) \geq K_u^{2N+1} e_u^{\frac{2N+1}{\rho} - (2N+1)2^{-\epsilon_1 R}} \rho^{-(2N+1)} \times 2^{(f(\zeta_{\epsilon_1}) - c(k)R - \epsilon_2)R} \text{Vol}\{\mathbf{O}_{u,\epsilon_1} \cap I_{\epsilon_2}\}. \quad (58)$$

Then,

$$\begin{aligned} \frac{O_-(R, \rho)}{O_+(R, \rho)} &\leq e_u^{(2N+1)2^{-\epsilon_1 R} - 2^{\epsilon_0 R}} \times \\ &\quad 2^{(f(\zeta_{-\epsilon_0}) - f(\zeta_{\epsilon_1}) + \epsilon_2)R} \frac{\text{Vol}\{\mathbf{O}_{u,-\epsilon_0}\}}{\text{Vol}\{\mathbf{O}_{u,\epsilon_1} \cap I_{\epsilon_2}\}}. \end{aligned} \quad (59)$$

Note that the right hand side of (59) seem to be approaching infinity because the exponents of 2 grow polynomially with R which approaches infinity when ρ is approaching infinity. But they actually decay exponentially with $2^{\epsilon_0 R}$ for a given ϵ_0 .

So we obtain the conclusion as following,

$$\limsup_{\substack{\rho \rightarrow \infty \\ (R, \rho) \in \mathbf{R}(k)}} \frac{\log \left(1 + \frac{O_-(R, \rho)}{O_+(R, \rho)} \right)}{\log \rho} = 0. \quad (60)$$

Now, we should only find the supremum of $(\log O_+(R, \rho)) / \log \rho$. In region $\mathbf{O}_{u,\epsilon_0}$, there exists

$$O_+(R, \rho) \leq \left(\frac{K_u}{\rho} \right)^{2N+1} 2^{(f(\zeta_{\epsilon_0}) - c(k))R}. \quad (61)$$

So we get

$$\begin{aligned} \frac{\log P_o(R, \rho) - c(k)R}{\log \rho} &\leq \frac{\log K_u^{2N+1}}{\log \rho} - (2N+1) + \\ &\quad (f(\zeta_{\epsilon_0}) - c(k)) \frac{R}{\log \rho}. \end{aligned} \quad (62)$$

Take steps very similar to those outlined from (43) to (51), meanwhile make δ and ϵ_0 approach 0. Then,

$$\begin{aligned} \limsup_{\substack{\rho \rightarrow \infty \\ (R, \rho) \in \mathbf{R}(N > k \geq 0)}} \frac{\log P_o(R, \rho) - c(k)R}{\log \rho} &\leq -(N+1) \\ &\quad + \left(1 + \frac{lN}{l-1} - c(k) \right) \times \limsup_{\substack{\rho \rightarrow \infty \\ (R, \rho) \in \mathbf{R}(N > k \geq 0)}} \frac{R}{\log \rho}, \\ \limsup_{\substack{\rho \rightarrow \infty \\ (R, \rho) \in \mathbf{R}(k=N)}} \frac{\log P_o(R, \rho) - c(k)R}{\log \rho} &\leq -1 \\ &\quad + (1 - c(k)) \times \limsup_{\substack{\rho \rightarrow \infty \\ (R, \rho) \in \mathbf{R}(k=N)}} \frac{R}{\log \rho}. \end{aligned} \quad (63)$$

We get the proof in the case $(l-1)_N = 0$ by combining (52) and (63). While in the case $(l-1)_N = m$, since the remaining m symbols which are transmitted by m relays in a new round, if we select the m best relays and m worst relays according to the $s \rightarrow r$ channels quality, that is, $\alpha_0 \geq \alpha_1 \geq \dots \geq \alpha_{N-1} \geq 0$

and $\alpha_{N-1} \geq \alpha_{N-2} \geq \dots \geq \alpha_0 \geq 0$, two bounds can be acquired. Thus we have two definitions of $\mathbf{R}_\delta(k)$,

$$\mathbf{R}_{1,\delta}(k) \triangleq \begin{cases} \left\{ (R, \rho) \mid \frac{1}{\delta} > \frac{\log \rho}{R} > \frac{lN}{l-1+N-m} + \delta \right\}, & k = 0, \\ \left\{ (R, \rho) \mid \frac{lN}{(l-1+N-m)k} - \delta > \frac{\log \rho}{R} > \frac{lN}{(l-1+N-m)(k+1)} + \delta \right\}, & m > k > 0, \\ \left\{ (R, \rho) \mid \frac{lN}{(l-1-m)k+mN} - \delta > \frac{\log \rho}{R} > \frac{lN}{(l-1-m)(k+1)+mN} + \delta \right\}, & N > k \geq m, \\ \left\{ (R, \rho) \mid \frac{l}{l-1} - \delta > \frac{\log \rho}{R} > 1 + \delta \right\}, & k = N, \\ \left\{ (R, \rho) \mid 1 - \delta > \frac{\log \rho}{R} > \delta \right\}, & \text{others,} \end{cases} \quad (64)$$

$$\mathbf{R}_{2,\delta}(k) \triangleq \begin{cases} \left\{ (R, \rho) \mid \frac{1}{\delta} > \frac{\log \rho}{R} > \frac{lN}{l-1-m} + \delta \right\}, & k = 0, \\ \left\{ (R, \rho) \mid \frac{lN}{(l-1-m)k} - \delta > \frac{\log \rho}{R} > \frac{lN}{(l-1-m)(k+1)} + \delta \right\}, & N - m > k > 0, \\ \left\{ (R, \rho) \mid \frac{lN}{(l-1+N-m)k+mN-N^2} - \delta > \frac{\log \rho}{R} > \frac{lN}{(l-1+N-m)(k+1)+mN-N^2} + \delta \right\}, & N > k \geq N - m, \\ \left\{ (R, \rho) \mid \frac{l}{l-1} - \delta > \frac{\log \rho}{R} > 1 + \delta \right\}, & k = N, \\ \left\{ (R, \rho) \mid 1 - \delta > \frac{\log \rho}{R} > \delta \right\}, & \text{others.} \end{cases} \quad (65)$$

When δ is approaching to 0, we can see that $\mathbf{R}_{1,\delta}(k)$ transfers to the same form as (26) which has three super operating regions, so does $\mathbf{R}_{2,\delta}(k)$. The value of $f(\zeta_{\epsilon_0})$ fluctuates with the $\mathbf{R}_\delta(k)$. So we get $f_1(\zeta_{\epsilon_0})$ and $f_2(\zeta_{\epsilon_0})$ which correspond to $\mathbf{R}_{1,\delta}(k)$ and $\mathbf{R}_{2,\delta}(k)$ respectively, i.e.,

$$f_1(\zeta_{\epsilon_0}) = \begin{cases} 1 + \frac{lN}{l-1+N-m} + N \left(\frac{\log \rho}{R} \pm \epsilon_0 \right), & m > k \geq 0, \\ 1 + \frac{lN}{l-1-m} + \frac{lN-N-2mN}{l-1-m} \left(\frac{\log \rho}{R} \pm \epsilon_0 \right), & N > k \geq m, \\ 1 + 2 \left(\frac{\log \rho}{R} \pm \epsilon_0 \right) N, & k = N, \\ \left(\frac{\log \rho}{R} \pm \epsilon_0 \right) (2N + 1), & \text{others,} \end{cases} \quad (66)$$

$$f_2(\zeta_{\epsilon_0}) = \begin{cases} 1 + \frac{lN}{l-1-m} + N \left(\frac{\log \rho}{R} \pm \epsilon_0 \right), & N - m > k \geq 0, \\ 1 + \frac{lN}{l-1+N-m} - \frac{mN-N^2}{l-1+N-m} \left(\frac{\log \rho}{R} \pm \epsilon_0 \right) + N \left(\frac{\log \rho}{R} \pm \epsilon_0 \right), & N > k \geq N - m, \\ 1 + 2 \left(\frac{\log \rho}{R} \pm \epsilon_0 \right) N, & k = N, \\ \left(\frac{\log \rho}{R} \pm \epsilon_0 \right) (2N + 1), & \text{others.} \end{cases} \quad (67)$$

$c(k)$ and $g(k)$ can then be derived in the light of $f(\zeta_{\epsilon_0})$. Thus, we complete the proof. \square

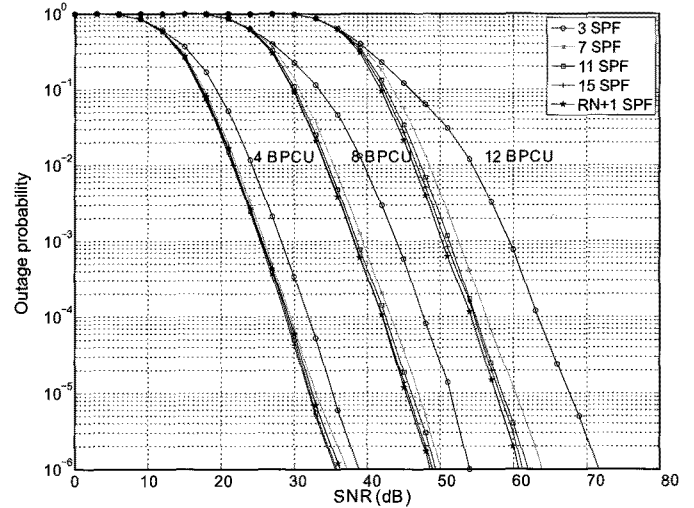

Fig. 3. Outage probability with different frame length in 2-relay scenario.

V. NUMERICAL RESULTS

In this section, we investigate the numerical results by using Monte-Carlo simulations. In SSDF, large frame length l causes a good system performance since a larger l means the more symbols are protected by relays and the more diversity gain can be obtained. So our first simulation will show the impact of the frame length on the outage probability. Then we focus on the outage probability analyzed by the TRT formulation and the concept of operating regions given by *Theorem 1* to explain the asymptotic trends exhibited by the outage probability curves.

A. Frame Length Impact on The Outage Probability Curves

In 2-relay scenario, we give the outage probability curves under different information rate, i.e., 4, 8, and 12 BPCU. To exhibit the effect of frame length, we consider situations of 3, 7, 11, 15 symbols per frame (SPF). Due to round-robin scheme, only $1/l$ can not be protected by relays in a frame. We can conclude that frame length l contributes largely to the performance of outage probability. The longer the frame length is, the better the performance of outage probability is.

On the other hand, if l is large enough, the advantage brought by l will weaken since $\lim_{l \rightarrow \infty} 1/(l + \Delta l) = 1/l$ when there is a Δl growth in frame length. Fig. 3 shows that we can adopt $l = RN + 1$ as the upper bound of frame length in simulations. Meanwhile, the feature of round-robin scheme determines that $l \geq N + 1$. So we choose $N + 1$ as the lower bound of frame length in simulations. In the following numerical experiments, we only take these two kinds of frame length into account.

B. TRT Prediction on Outage Probability Curves

The result of TRT formulation gives the bound of $P_o(R, \rho)$ and hints that it may achieve this bound when ρ approaches to infinity, that is,

$$\log P_o(R, \rho) = c(k)R - g(k) \log \rho \text{ for } (R, \rho) \in \mathbf{R}(k). \quad (68)$$

The priori subsection has emphasized that frame length has distinct influences on the outage curves. Nevertheless, another in-

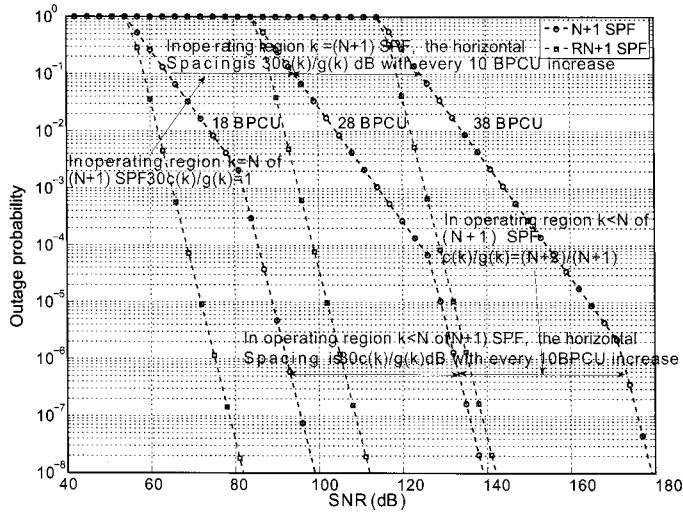

Fig. 4. Outage probability predicted by TRT formulation with frame length $(N + 1)$ and $(RN + 1)$ in 2-relay scenario. In this figure, $(l - 1)_N = 0$.

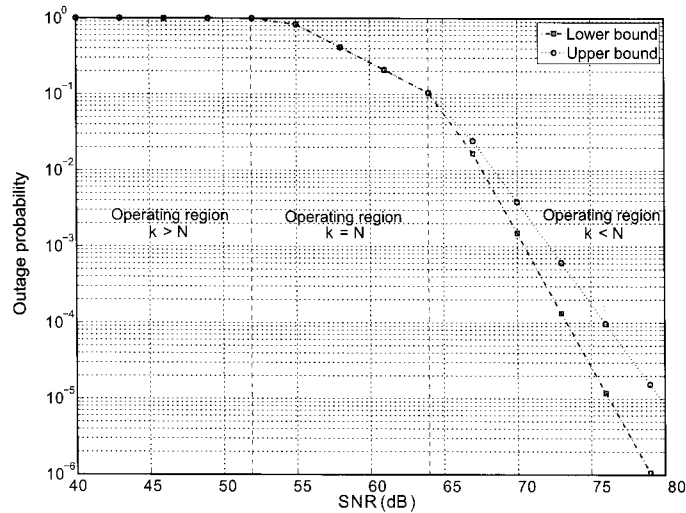

Fig. 5. Outage probability predicted by TRT formulation with 18 BPCU and 6 SPF in 2-relay scenario. In this figure, $(l - 1)_N \neq 0$.

fluence on the outage probability is whether $(l - 1)_N = 0$ or not. *Theorem 1* implies that it is more intractable when $(l - 1)_N \neq 0$, and gives the two sets of operating regions, which directly leads to the two bounds of $P_o(R, \rho)$. Our simulations take the two situations into account.

Firstly, let us have an in-depth study on the theoretic outage probability curves predicted by TRT. By applying the concept of operating regions, TRT rule gives more useful information than DMT rule on the asymptotic trends exhibited by the outage probability curves. Generally speaking, SSDF protocol is an imitated process of multi-antenna. In $\mathbf{R}(N)$, it can be seen as an SISO system, while in $\mathbf{R}(k < N)$, it mimics a MISO system. So the multiplexing gain can not exceed 1. In [23], the authors point out that the slope of each segmented line represents the reliability gain coefficient $g(k)$, which corresponds to the largest diversity gain of $\mathbf{R}(k)$. In the operating region k , there is an relationship, i.e., $\Delta \log \rho \approx c(k)/g(k)\Delta R$. So in the outage probability vs SNR(dB) curves, the horizontal spacing in decibels between two outage probability curves with a ΔR rate

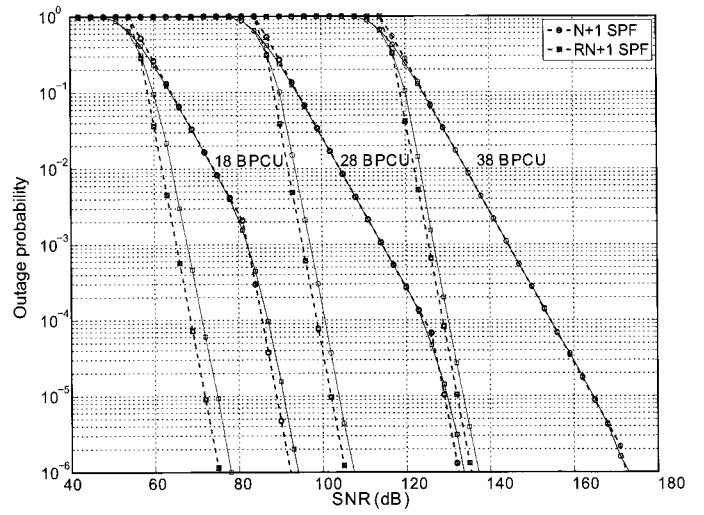

Fig. 6. Outage probability curves in two-relay scenario when $(l - 1)_N = 0$ (solid), along with the piecewise linear approximation (dashed) suggested by the TRT. Two kinds of frame length (the shortest and the longest frame) are taken into account.

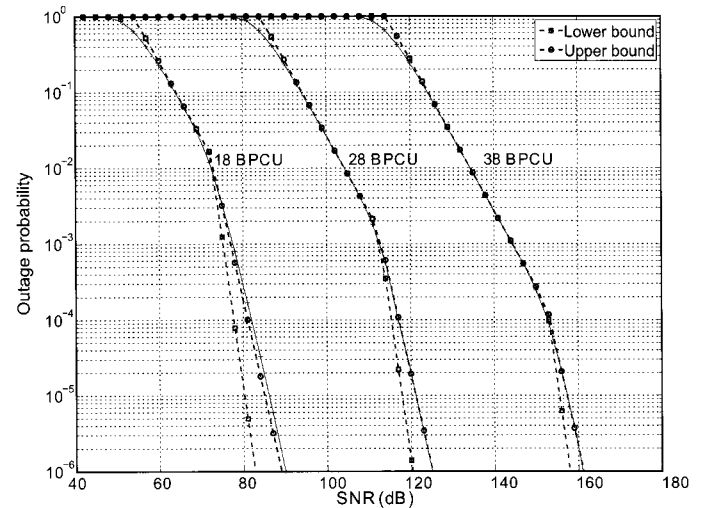

Fig. 7. Outage probability curves in two-relay scenario when $(l - 1)_N \neq 0$ (solid), along with the two bounds of the piecewise linear approximation (dashed) suggested by the TRT with 4 SPF.

difference is give by $3\Delta R/t(k)$, where $t(k) = g(k)/c(k)$ is the throughput gain coefficient.

Figs. 4 and 5 are the theoretic results predicted by TRT formulation. Fig. 4 shows the case when $(l - 1)_N = 0$ where $l = N + 1$ and $l = RN + 1$ are considered. More detail analysis is focused on the case when $l = N + 1$ in Fig. 4, which exhibits the relationship between ΔR and $\Delta \rho$ in different operating regions. Fig. 5 shows the case $(l - 1)_N \neq 0$. When $k < N$, there are lower bound and upper bound corresponding to the case that the best source-relay channels first use (BCFU) and the case that the worst source-relay channels first use (WCFU) respectively. From Fig. 5, we can observe the outage probability in each operating region when $(l - 1)_N \neq 0$. The regions of $k > N$ can be looked as outage region in which the outage probability is always equal to 1, and the difference between BCFU and WCFU happens in the operating regions when $k < N$ if $(l - 1)_N \neq 0$.

At last, we will use the formulation (68) to show that TRT rule

can linearly approach the simulative outage probability curves in each operating region. According to [23], for operating point $(R, \rho) \in \mathbf{R}(k)$, We should find the smallest value of ϵ such that $\rho^k/2^R \leq \epsilon$ and $2R/\rho^{k+1} \leq \epsilon$. The smaller ϵ is, the better the approximation becomes. So we consider 18, 28, and 38 BPCU with different SPF in 2-relay scenarios. In each BPCU, we consider $(N+1)$ SPF and $(RN+1)$ SPF when $(l-1)_N = 0$, while $(N+2)$ SPF when $(l-1)_N \neq 0$. Fig. 6 and 7 are the simulations under the cases when $(l-1)_N = 0$ and $(l-1)_N \neq 0$ respectively. As $\rho \rightarrow \infty$, TRT formulation (shown as dashed lines) exhibits the linear asymptotic trends to the numerical experiments (shown as solid lines).

VI. CONCLUSION

We base our works on the Azarian and Gamal's elegant TRT formulation concluded from MIMO systems [23] to throw a light on the asymptotic interplay between R , $\log \rho$, and $P_o(R, \rho)$ in DF protocols. By applying symbol based round-robin scheduling scheme, we get SSDF protocol which is used as the model to study TRT rule in DF protocols. Network information theory is applied to the model to obtain the system outage regions. Then we prove that TRT formulation also exists in SSDF cooperative system and deduce the corresponding operation regions. Simulations validate our deduction on the condition that SNR is large enough.

REFERENCES

- [1] J. N. Laneman and G. W. Wornell, "Distributed space-time-coded protocols for exploiting cooperative diversity in wireless networks," *IEEE Trans. Inf. Theory*, vol. 49, no. 10, pp. 2415–2425, Oct. 2003.
- [2] J. N. Laneman, D. N. C. Tse, and G. W. Wornell, "Cooperative diversity in wireless networks: Efficient protocols and outage behavior," *IEEE Trans. Inf. Theory*, vol. 51, no. 12, pp. 3062–3080, Dec. 2004.
- [3] R. U. Nabar, F. W. Kneubuhler, and H. Bölcskei, "Performance limits of amplify-and-forward based fading relay channels," in *Proc. IEEE Int. Conf. Acoustics, Speech and Signal Processing*, vol. 4, Montreal, QC, Canada, May 2004, pp. 565–568.
- [4] R. U. Nabar, H. Bölcskei, and F. W. Kneubuhler, "Fading relay channels: Performance limits and space-time signal design," *IEEE J. Sel. Areas Commun.*, vol. 22, no. 6, pp. 1099–1109, Aug. 2004.
- [5] J. Li and W. Chen, "Power allocation in the high SNR regime for a multicast cell with regenerative network coding," *IEEE Commun. Lett.*, vol. 13, no. 4, pp. 271–273, 2009.
- [6] J. Li and W. Chen, "Joint power allocation and precoding for network coding based cooperative multicast systems," *IEEE Signal Process. Lett.*, vol. 15, pp. 817–820, 2008.
- [7] M. Janani, A. Hedayat, T. Hunter, and A. Nosratinia, "Coded cooperation in wireless communications: Space-time transmission and iterative decoding," *IEEE Trans. Signal Process.*, vol. 52, no. 2, pp. 362–371, Feb. 2004.
- [8] G. Kramer, M. Gastpar, and P. Gupta, "Cooperative strategies and capacity theorems for relay networks," *IEEE Trans. Inf. Theory*, vol. 51, no. 9, pp. 3037–3063, Sept. 2005.
- [9] K. Azarian, H. El-Gamal, and P. Schniter, "On the achievable diversity-multiplexing tradeoff in half-duplexing cooperative channels," *IEEE Trans. Inf. Theory*, vol. 51, no. 12, pp. 4152–4172, Dec. 2005.
- [10] J. Li and W. Chen, "On the diversity-multiplexing tradeoff of cooperative multicast system with wireless network coding," *J. of Commun. Netw.*, 2009.
- [11] S. Yang and J.-C. Belfiore, "Towards the optimal amplify-and-forward cooperative diversity scheme," *submitted to IEEE Trans. Inf. Theory*, Mar. 2006.
- [12] M. Yuksel and E. Erkip, "Cooperative wireless systems: A diversity-multiplexing tradeoff perspective," *IEEE Trans. Inf. Theory*, vol. 53, no. 10, pp. 3371–3393, 2006.
- [13] T. M. Cover and A. A. El-Gamal, "Capacity theorems for the relay channel," *IEEE Trans. Inf. Theory*, vol. 25, no. 5, pp. 572–584, Sept. 1979.
- [14] T. M. Cover and G. S. L. Leung, "An achievable rate region for the multiple-access channel with feedback," *IEEE Trans. Inf. Theory*, vol. 27, no. 3, pp. 292–298, May 1981.
- [15] L. H. Ozarow, "The capacity of the white gaussian multiple access channel with feedback," *IEEE Trans. Inf. Theory*, vol. 30, no. 4, pp. 623–629, July 1984.
- [16] T. M. Cover, "Comments on broadcast channels," *IEEE Trans. Inf. Theory*, vol. 44, no. 6, pp. 2524–2530, Oct. 1998.
- [17] P. Gupta and P. R. Kumar, "Towards an information theory of large networks: An achievable rate region," *IEEE Trans. Inf. Theory*, vol. 49, no. 8, pp. 1877–1893, Aug. 2003.
- [18] L. Zheng and D. N. C. Tse, "Diversity and multiplexing: A fundamental tradeoff in multiple antenna channels," *IEEE Trans. Inf. Theory*, vol. 49, no. 5, pp. 1073–1096, May 2003.
- [19] K. Azarian and H. El Gamal, "The throughput-reliability tradeoff in block-fading MIMO channels," *IEEE Trans. Inf. Theory*, vol. 53, no. 2, pp. 488–501, Feb. 2007.
- [20] R. Narasimhan, "Finite-SNR diversity-multiplexing tradeoff for correlated Rayleigh and Rician MIMO channels," *IEEE Trans. Inf. Theory*, vol. 52, no. 9, pp. 3965–3979, Sept. 2006.
- [21] E. Staufner, Ö. Oyman, R. Narasimhan, and A. Paulraj, "Finite-SNR diversity-multiplexing tradeoffs in fading relay channels," *IEEE J. Sel. Areas Commun.*, vol. 25, no. 2, pp. 245–257, Feb. 2007.
- [22] J. Li and W. Chen, "On the throughput-reliability tradeoff analysis in amplify-and-forward cooperative channels," in *Proc. IEEE ICC*, Beijing, China, May 2008.
- [23] J. Li and W. Chen, "Throughput-reliability tradeoff Analysis in amplify-and-forward cooperative channels," *submitted to IEEE Trans. Inf. Theory*.
- [24] L. Ozarow, S. Shamai, and A. Wyner, "Information-theoretic considerations in cellular mobile radio," *IEEE Trans. Veh. Technol.*, vol. 43, no. 3, pp. 359–378, May 1994.



Jun Li was born in 1980. He received B.S. degree in Electrical Engineering from Jilin University, Changchun, China, in 2001, the M.Sc. degree in Electronic Engineering from Nanjing University of Science and Technology, Nanjing, China, in 2004, and the Ph.D. in Electric Engineering from Shanghai Jiaotong University in 2009. Then he joins Shanghai Bell lab as a technical staff. He is now working as a postdoctoral fellow in University of New South Wales, Australia. He is the Technical Program Committee Member for IEEE-ICCSC 2008 and ISCSCT 2008. He has published 8 papers in IEEE journals and conferences. His interests include network information theory, channel coding theory, and cooperative communications.



Wen Chen was born in 1967. He received B.S. and M.Sc. from Wuhan University, China in 1990 and 1993, respectively. He received the Ph.D. from University of Electro-Communications, Tokyo, Japan in 1999. He was a research fellow of Japan Society for the Promotion of Sciences (JSPS) from 1999 through 2001. In 2001, he joined University of Alberta, Canada, starting as a post-doctoral fellow in Information Research Lab and continuing as a research associate in Department of Electrical and Computer Engineering. Since 2006, he has been a Full Professor in Department of Electronic Engineering, Shanghai Jiaotong University, China, where he is also the Director of Institute for Signal Processing and Systems. He was Awarded the Ariyama Memorial Research Prize in 1997, the PIMS Post-Doctoral Fellowship in 2001. He received the honors of "New Century Excellent Young Scholar in China" in 2006 and "the Pujiang Excellent Scholar in Shanghai" in 2007. He is elected to the vice general secretary of Shanghai Institute of Electronics in 2008. He is in the editorial board of the International Journal of Wireless Communications and Networking, and serves Journal of Communications and EURASIP Journal on Wireless Communications and Networking as guest editors. He is the Technical Program Committee chair for IEEE-ICCSC 2008, the General Conference Chair for IEEE-ICIS 2009. He has published more than 60 papers in IEEE and IEICE journals and conferences. His interests cover network coding, cooperative communications, OFDM coding, and MIMO-OFDM precoding.