

Series Resonant ZCS- PFM DC-DC Converter using High Frequency Transformer Parasitic Inductive Components and Lossless Inductive Snubber for High Power Microwave Generator

Soon-Kurl Kwon[†], Bishwajit Saha^{*}, Sang-Pil Mun^{*},
Kazunori Nishimura^{**} and Mutsuo Nakaoka^{*,***}

[†]Kyungnam University, Masan, Korea

^{**}Hiroshima Institute of Technology, Hiroshima, Japan

^{***}Industrial College of Technology University, Japan

ABSTRACT

Conventional series-resonant pulse frequency modulation controlled DC-DC high power converters with a high-frequency transformer link which is designed for driving the high power microwave generator has the problem of hard switching commutation at turn-on and turn-off of active power switching devices. This problem is due to the influence of the magnetizing current of the high-frequency transformer. This paper presents a novel prototype for a high-frequency transformer using parasitic parameters with a lossless inductive snubber and a series resonant capacitor assisted series-resonant zero current switching pulse frequency modulated DC-DC power converter, which is designed using a high power magnetron for microwave ovens. In order to implement a complete and efficient soft switching commutation, the performance of the new converter topology is practically confirmed and evaluated in the prototype of a power microwave generator.

Keywords: Series resonant inverter, High frequency transformer link, Voltage doubler rectifier, Magnetron, ZCS-PFM

1. Introduction

With great advances of power semiconductor switching devices such as MOSFETs, IGBTs, and ESBTs as well as

high-frequency passive circuit components, the leading development of the high-frequency resonant pulse inverter type switching mode DC-DC power conversion circuits and systems have attracted special interest for high voltage DC power applications ^{[1]-[5]}. High-frequency resonant pulse soft-switching DC-DC converters using MOS gate power semiconductor devices are actively introduced in this new particular field of small power electronic applications. On the other hand, IGBTs or MOS gate bipolar transistors are more suitable for zero current switching (ZCS)

Manuscript received April 3, 2008; revised October 14, 2008

[†] Corresponding Author: soonkurl@kyungnam.ac.kr

Tel: +82-55-249-2633, Fax: +82-55-249-2839, Kyungnam Univ.

^{*}Dept. of Electrical Engineering of Kyungnam Univ.

^{**}Hiroshima Institute of Technology, Japan

^{***}Industrial College of Technology Univ., Japan

commutation rather than zero voltage switching (ZVS) due to their associated inherent tail currents at turn off switching commutations [4]. Thus, the series resonant inverters and converters operating under the principle of ZCS commutation are practically recommended from the switching losses point of view.

Most conventional series-resonant circuit topologies of high frequency inverters can operate under a commutation principle of ZCS based on a discontinuous current mode (DCM) control. However, in high frequency transformer link topologies it is difficult to implement the DCM in the conventional type circuit due to the influence of the magnetizing current that flows through the high-frequency transformer's primary side. Especially, the influence of the magnetizing current is remarkable for the DC-DC converters with a capacitor type output-smoothing filter and a constant high-voltage load as in the power magnetron of microwave appliances.

This paper presents a high-frequency transformer with parasitic parameters and a lossless inductive snubber assisted series-resonant DC-DC power converter with a voltage doubler rectifier circuit, which can operate under ZCS commutation based on a pulse frequency modulation (PFM) in order to effectively improve the problem of the transformer magnetizing-inductive components-based hard switching commutation. This new circuit topology can actively utilize the transformer parasitic circuit components as leakage and magnetizing inductance to achieve ZCS operation with the aid of a lossless inductive snubber and series resonance capacitor in the high voltage transformer's primary side. The performance evaluations as the switching voltage and current waveforms of the power semiconductor switches, DC power regulation and power conversion efficiency characteristics are practically confirmed and evaluated as applied to the power magnetron of the microwave generator for plasma application.

2. Equivalent Circuit Model of Magnetron

The heart of any microwave generator is the high voltage system. Its purpose is to generate microwave energy. The high-voltage components accomplish this by stepping up AC line voltage to high voltage, which is then changed to an even higher DC voltage. This DC power is then converted to

the RF (microwaves) energy that cooks the food. Microwaves are very short waves of electromagnetic energy that travel at the speed of light. Microwaves used in microwave ovens are in the same family of frequencies as the signals used in radio and television broadcasting. Electromagnetic forms of energy, such as microwaves, radar waves, radio and TV waves, travel millions of miles through the emptiness of space without the need of any material medium through which to travel.

Fig. 1 indicates the input voltage vs. input current characteristics of the power magnetron. As shown in this figure, the magnetron has non-linear input characteristics, what can be represented with piecewise linear approximation which includes a high resistance area in a non-oscillating region and a low resistance area in the oscillating region for the magnetron. When the voltage between the anode and cathode exceeds about 7.4 kV (cut-off voltage), the magnetron anode current begins to flow from the anode to cathode. On the other hand, when the voltage between the anode and cathode is lower than the cut-off voltage the anode current flows slowly. The cut-off voltage of magnetron fluctuates a little with the operating temperature which depends on the characteristics of the ferrite magnet in the magnetron, which are not considered here for the approximate v-i characteristics.

The electrical equivalent circuit model of the magnetron can be simply represented by using pure resistances R_0 and R_1 , an ideal diode D , an ideal battery V_Z (cut-off voltage) and an ideal switch as shown in Fig. 2. As illustrated in this figure, the position of the ideal switch in the equivalent circuit of the magnetron is selected whether the voltage between the anode and cathode is higher than the cut off voltage or not. In this paper, stable microwave power is required for semiconductor manufacturing production in industrial applications and the magnetron is used under the condition of continuous oscillation. Therefore, only a stable oscillation state is considered for the converter operation.

3. Series-Resonant DC-DC Converter with High-Frequency Transformer Link

3.1 Operation in Discontinuous Current Mode

Fig. 3 shows the schematic circuit configuration of a

conventional type DC-DC power converter with a high-frequency transformer(HFT) link and voltage doubler circuit, which is designed for a high power magnetron drive in industrial power applications (this circuit is called circuit 1). This DC-DC converter circuit is composed of a high frequency high voltage transformer, resonant high-frequency full bridge inverter with a series resonant capacitor C_r in the primary side of the high frequency transformer, full-wave voltage doubler type rectifier circuit, current smoothing inductor L_o , and a magnetron to generate microwave power in the high frequency transformer's secondary side. The magnetron of Fig. 3 is represented by its electrical equivalent circuit shown in Fig. 2 under the condition of continuous oscillations. The circuit parameters and the design specifications of the circuit (see Fig. 3) are indicated in Table 1.

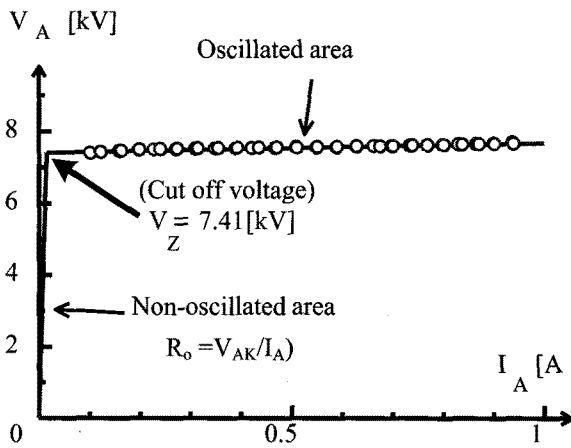

Fig. 1 Experimental characteristics of magnetron

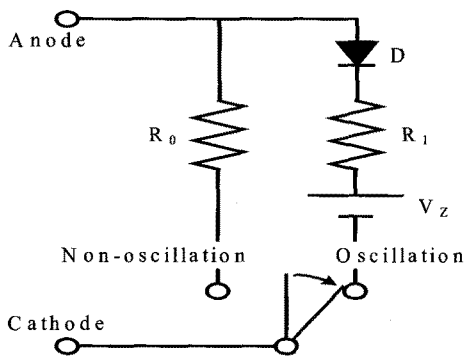

Fig. 2 Electrical equivalent circuit model of magnetron

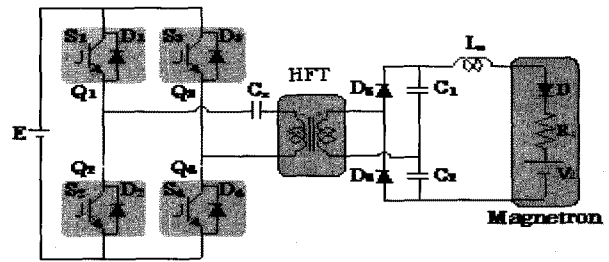

Fig. 3 High frequency link series resonant DC-DC converter(Circuit 1)

Table 1 Design specifications and circuit parameters of circuit 1

| Items | Symbol | Value |
|--|-------------|--------------|
| Equivalent DC voltage of input source | E | 283 V |
| Leakage inductance of HFT | L_t | 2.3 mH |
| Primary self-inductance of HFT | L_1 | 26.4 mH |
| Turn ratio of HFT | N_2 / N_1 | 20 |
| Capacitance of series resonant capacitor | C_r | 467.3 nF |
| Capacitance of output filter capacitor | C_1, C_2 | 11 nF |
| Inductance of output filter inductor | L_o | 0.3 H |
| Cut-off voltage of magnetron | V_z | 7.41 kV |
| Equivalent resistance of magnetron | R_1 | 266 Ω |

In the oscillating state of the magnetron, its input side DC voltage can be considered nearly constant since it is represented by a linear v-i characteristic with a small slope as indicated in Fig. 1. Thus, the microwave power from the magnetron is proportional to its anode current. Therefore, the output power of the magnetron can be regulated by controlling the anode current with a closed feedback loop. Consequently, runaway of the magnetron is prevented and stable high microwave power can be effectively generated and controlled.

The steady state voltage and current waveforms in DCM operation in the previously-developed series resonant DC-DC converter are illustrated in Fig. 4. In this case, the current through the transformer primary winding is discontinuous. As shown in Fig. 4, the gate pulse signal sequences of the IGBTs are designed to regulate the pulse frequency under constant on-time condition. The IGBTs are turned on with ZCS and turned off with hybrid ZVS & ZCS (IGBTs are turned off with ZVS and anti-parallel diodes are turned on with ZCS) in all power regulation ranges when the switching frequency of this DC-DC converter is less than half of the resonant frequency. This is decided by the

resonant capacitor and the leakage inductance of the high-frequency transformer. If the switching frequency is increased more than half of the resonant frequency, the bridge current of this converter becomes a continuous waveform and this converter operates in continuous current mode (CCM). Consequently, the operation becomes hard switching.

However, in the case of using a high-frequency transformer with leakage and magnetizing parasitic circuit parameters (L_l , L_m), it is actually difficult to realize the DCM operation to achieve a zero current soft commutation. In order to implement this operating mode, it is necessary that the magnetizing current through the high-frequency transformer primary winding be nearly zero. Nevertheless, the magnetizing current remarkably flows in the DC-DC converter with a capacitor input type output-smoothing circuit and a constant high voltage load as the magnetron is equal to zero. Because the output rectifier circuit is cut off when the secondary side voltage of the high-frequency transformer is less than the output-smoothing capacitor voltage, and the series resonant inverter is isolated separately from the voltage doubler rectifier with the capacitor input filter. In this case, only the magnetizing current of the transformer circulates through the circuit of the transformer's primary side during the cut off mode of the voltage doubler type rectifier. Consequently, the discontinuous current operating mode (see Fig. 5) of this converter can not appear and be realized practically.

3.2 Magnetizing Inductor Hard Switching Operating Mode

Fig. 5 shows the measured operating waveforms of the current flowing through each IGBT switch and the voltage across it of circuit 1 (see Fig. 3). In comparison with the simulation voltage and current waveforms in Fig. 4, the measured switch current waveforms observed in Fig. 5 are distorted.

It is easily proven that this power converter operates under a hard switching mode due to the remarkably confirmed high voltage surges in the operating current and voltage waveforms.

At turn-on switching transition, the high-frequency transformer's primary side current has an initial value due to the magnetizing current through the high-frequency high-voltage transformer.

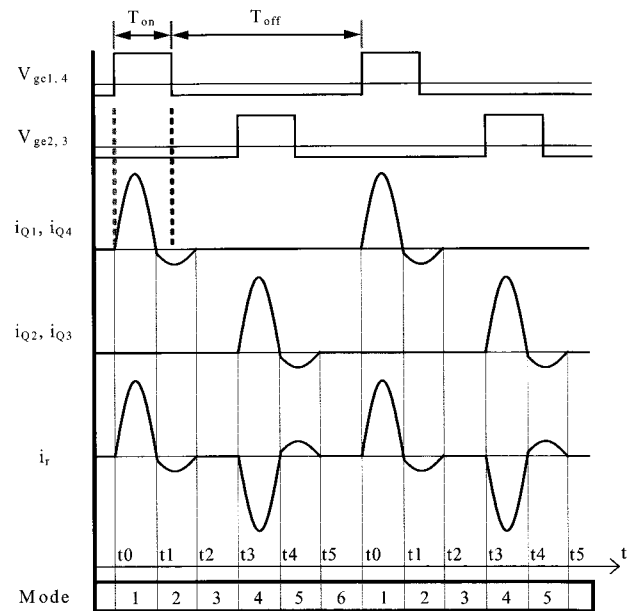

Fig. 4 Operating waveforms in discontinuous current mode

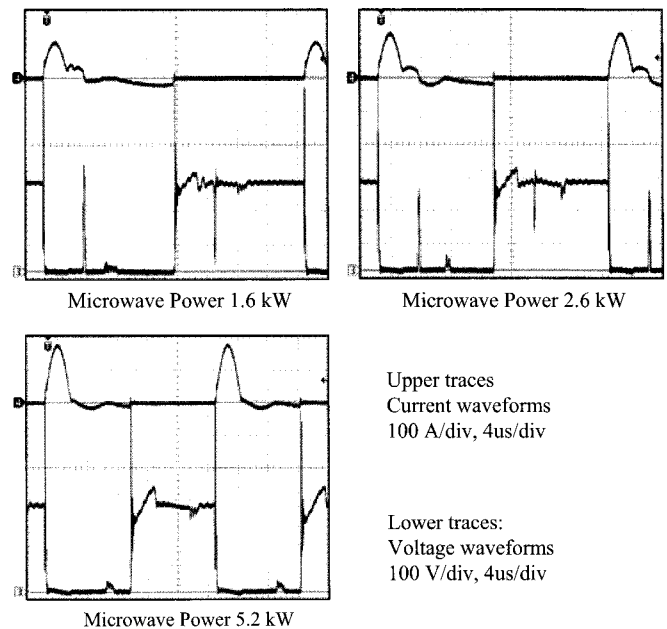

Fig. 5 Experimental voltage and current waveforms of Q1 (Circuit 1)

Therefore, the current flowing through the switches jumps to this initial value, and the IGBTs in the bridge arms of the series transformer resonant inverter has hard switching commutation at turn-on in all power regulation setting ranges. Extremely high voltage surges actually occur with this high di/dt stress. At turn-off switching transition,

the case which occurs while the current flowing through the IGBT switches is forcibly cut off to zero before the zero current crossing point. Consequently, the IGBT switches are turned-off at hard switching transitions.

4. Improved Series Resonant DC-DC Power Converter with Lossless Inductive Snubber

In order to solve the significant problem mentioned above, a single inductive snubber assisted series-resonant ZCS-PFM DC-DC power converter with a high-frequency transformer(HFT) link is proposed in Fig. 6 (this circuit is called circuit 2). This DC-DC power converter has a single inductive lossless snubber L_s in the input DC busline of the full bridge series resonant inverter. The current flowing through each IGBT switch rises gradually at turn-on with the aid of this inductive snubber, and ZCS turn-on commutation can be achieved completely.

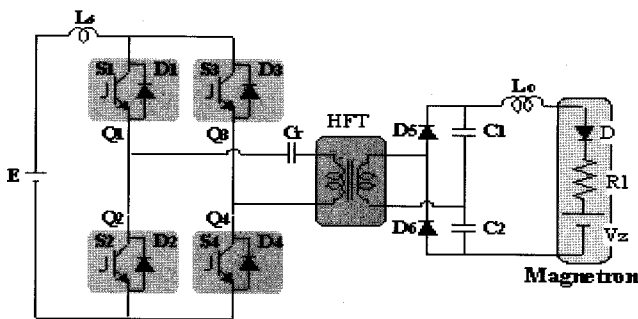

Fig. 6 Proposed soft switching DC-DC power converter (Circuit 2)

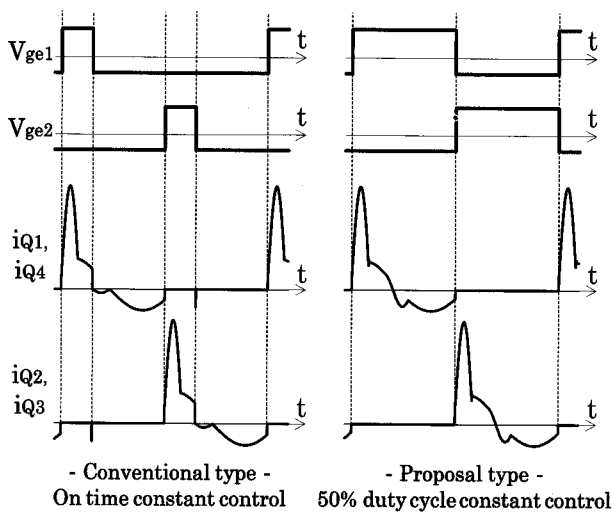

Fig. 7 50% duty cycle constant PFM control scheme

The gate pulse timing sequences of each IGBT of this DC-DC converter are illustrated in Fig. 7. The duty cycle of gate pulse signal of the IGBT is designed for a constant duty cycle of 50%. The pulse width of the gate signal varies with switching frequency. As shown in Fig. 8, the IGBT switches can be always turned off while a current continues to flow through the anti-parallel diodes and the primary winding of the high frequency transformer. Thereby, the IGBT switches can be turned off with ZVS & ZCS hybrid commutation. Furthermore, even though the dead time between two gate pulse signals is set to zero, the input DC busline of this newly developed DC-DC converter can not be shorted due to the effect of the single lossless inductive snubber connected in the input DC side of the full bridge inverter.

Table 2 Design specifications and circuit parameters of circuit 2

| Items | Symbol | Value [Unit] |
|--|-------------|--------------|
| Equivalent DC voltage of input source | E | 283 V |
| Lossless inductive snubber | L_s | 1 mH |
| Leakage inductance of HFT | L_t | 2.3 mH |
| Primary self-inductance of HFT | L_1 | 26.4 mH |
| Turn ratio of HFT | N_2 / N_1 | 20 |
| Capacitance of series resonant capacitor | C_r | 467.3 nF |
| Capacitance of output filter capacitor | C_1, C_2 | 11 nF |
| Inductance of output filter inductor | L_o | 0.3 H |
| Cut-off voltage of magnetron | V_z | 7.41 kV |
| Equivalent resistance of magnetron | R_1 | 266 Ω |

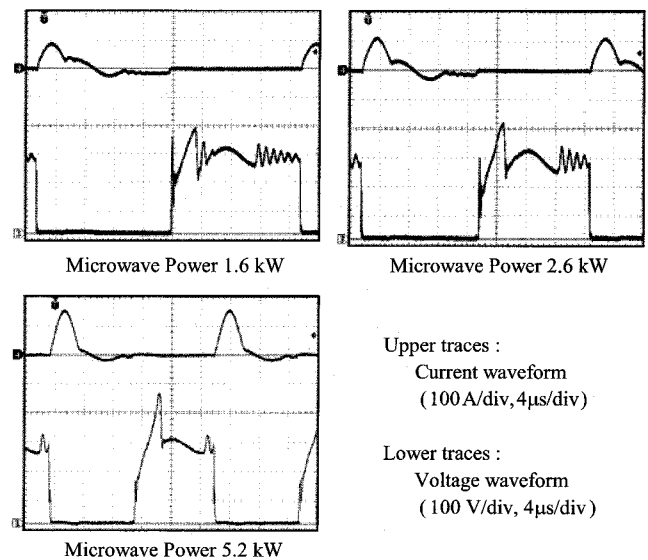

Fig. 8 Experimental voltage and current waveforms of Q1 (Circuit 2)

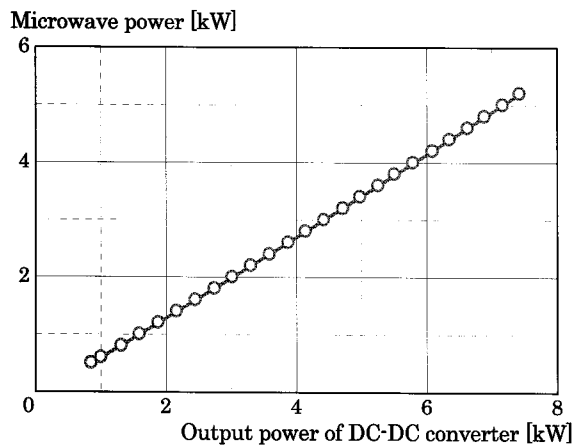

Fig. 9 Output power of DC-DC converter vs. microwave power

Therefore, it is possible for this DC-DC converter circuit to perform zero current soft switching commutation over a wide power regulation range in the PFM strategy. The design specifications of the DC-DC converter in this experiment are indicated in Table 2. The observed voltage and current operating waveforms of the IGBT switches in the proposed converter are shown in Fig. 8. Observing Fig. 8, it is easy to prove that this proposed DC-DC converter can operate under a principle of ZCS operation at both turn-on and turn-off transitions.

The microwave power regulation characteristics are shown in Fig. 9, while the measured efficiency characteristics for the output power settings of the circuit 1 and 2 are comparatively shown in Fig. 10. The power conversion efficiency of the proposed soft switching DC-DC converter is improved in comparison with that of conventional DC-DC converters in the wide range of high power settings.

5. Reducing Peak Current Stresses

When the switching frequency is more than half the resonant frequency, the conventional DC-DC converter operates at hard-switching transition mode in good condition. However, the proposed DC-DC converter operates at soft-switching transition even if the switching frequency is more than half the resonant frequency, because its soft-switching operation is based on continuous current mode.

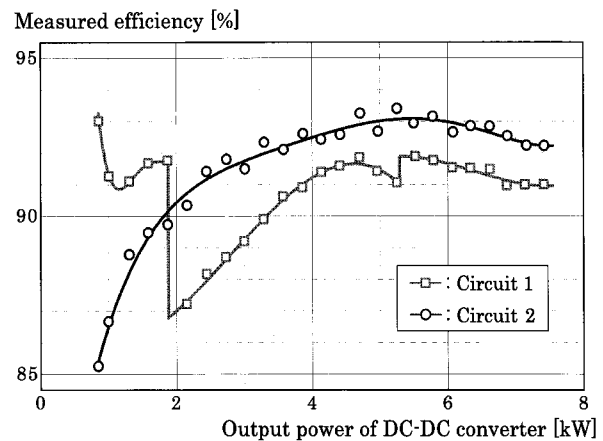

Fig. 10 Comparison of power conversion efficiency vs. output power characteristics for two converter topologies

The measured peak current values for a wide output power control range of the conventional and proposed DC-DC converter are indicated in Fig. 12. It is proven from this figure that the peak current value of IGBT on circuit 3 is lower than half of that of previous types over all power regulations.

The new design specification of this circuit is indicated in Table 3. These circuit parameters are designed to actively utilize the continuous current mode, in other words, the maximum switching frequency on circuit 3 is set near the resonant frequency of the resonant circuit to increase the utilization factor of electric power. Observing Fig. 11, it is confirmed that the peak values of the current flowing through the IGBT switches of circuit 3 are much lower than those of previous converter circuits (circuit 1 and circuit 2).

Table 3 New Design specifications and circuit parameters of circuit 2

| Items | Symbol | Value |
|--|---------------------------------|----------|
| Equivalent DC voltage of input source | E | 283 V |
| Lossless inductive snubber | L _s | 3.5 mH |
| Leakage inductance of HFT | L _ℓ | 11.3 mH |
| Primary self-inductance of HFT | L ₁ | 35.4 mH |
| Turn ratio of HFT | N ₂ / N ₁ | 20 |
| Capacitance of series resonant capacitor | C _r | 274.8 nF |
| Capacitance of output filter capacitor | C ₁ , C ₂ | 11 nF |
| Inductance of output filter inductor | L _o | 0.3 H |
| Cut-off voltage of magnetron | V _z | 7.41 kV |
| Equivalent resistance of magnetron | R ₁ | 266 Ω |

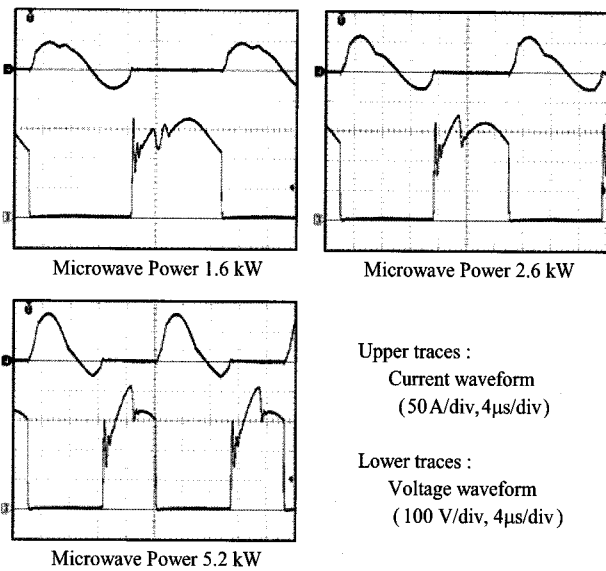

Fig. 11 Experimental voltage and current waveforms of Q1 (Circuit 3)

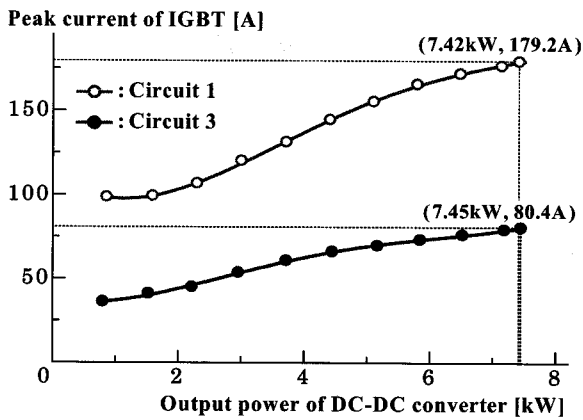

Fig. 12 Comparison of peak values of current flowing through IGBT

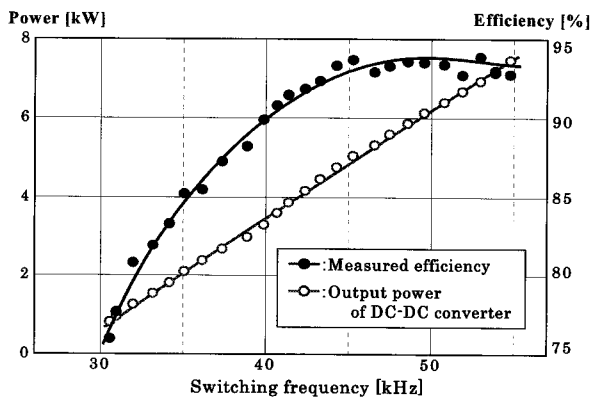

Fig. 13 Output power and measured efficiency vs. switching frequency characteristics with newly design specification of circuit 2

The measured peak current values for wide output power control range of conventional and the proposed DC-DC converter are indicated in Fig. 12. It is proven from this figure that the peak current value of the IGBT on circuit 3 is lower than half of previous types over all power regulation range. Efficiency improvement can be expected by improving the characteristics of IGBT switches with reduced peak current values and rated values. Fig. 13 shows the power conversion efficiency and the output power characteristics of the experimental prototype of the proposed DC-DC converter designed under the specifications of Table 3. The maximum value of the efficiency of circuit 3 shown in Fig. 13 is about 94.3[%], and this value is higher than that of circuit 2.

6. Conclusions

In this paper, a transformer parasitic parameter and a lossless inductive snubber assisted series-resonant ZCS-PFM DC-DC converter was proposed in order to improve the significant problems of hard switching commutation at turn-on and turn-off of the active power switching devices in a series-resonant PFM controlled DC-DC power converter with a high-frequency high-voltage transformer link. Based on the experimental results of the proposed pulse frequency modulated DC-DC power converter with a high-frequency high-voltage transformer, it was actually confirmed that all the active power switches could achieve ZCS commutation operation. ZCS commutation could be implemented within the DC power regulation range and high power conversion efficiency could be performed in a wide power regulation range. The transformer parasitic circuit components as leakage and magnetizing inductive components were effective to achieve soft switching (ZCS) operation with the aid of a single lossless inductive snubber. The peak values of the current flowing through the IGBT switches could be reduced by more than half of conventional DC-DC converters over all power regulation ranges by actively utilizing the continuous current mode operation with proper design selection of circuit parameters.

This paper was sponsored by Kyungnam University Research Fund 2007

References

- [1] A. Harada, "How to Use C.W. Magnetrons", *Proceedings of Microwave Effect and Application Symposium*, Japan, August 2001.
- [2] T. Matsushige, E. Miyata, M. Ishitobi, and M. Nakaoka, "Voltage-Clamped Soft-Switching Inverter-Fed DC-DC Converter for Microwave Oven and Utility AC Side Harmonic Current Evaluations", *Proceedings of IEEE-IAS International Appliance Technical Conference, IATC*, pp. 185-195, Kentucky, USA, May 2000.
- [3] T. Myoi, M. Ishitobi, L. Gamage, and M. Nakaoka, "Lossless Inductive Snubber-Assisted Series Resonant DC-DC Converter with ZCS-PFM Control Scheme", *Proceedings of International Power Electronics and Motion Control Conference (EPE-PEMC)*, Dubrovnik, Croatia, September 2002.
- [4] E. Hiraki, M. Nakaoka, "Practical Power Loss Analysis Simulator Development of Switching Mode Power Converter Using Measured Characteristic Values of Power Semiconductor Devices", *The Trans. of Institute of Electrical Engineering of Japan, IEEJ*, Vol. 122-D, No. 12, December 2002.
- [5] Yuzurihara, A. Takayanagi, and H. Fujikawa, "Microwave Generator System for Plasma Application (Vol. 2)", *Kyosan Technical Circular*, Vol. 53, No. 3, 2002.
- [6] Shibata, "Industrial Microwave Power Engineering", *Denkishoin Publishers Co., Ltd.*, December 1986.
- [7] K. Takahashi, "Base and Application of High Frequency", *Tokyo Denki University Book Press*, October, 1990.

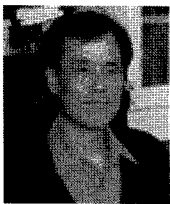

Soon-Kurl Kwon Received Ph. D (Dr-Eng) degree in Electrical Engineering from Young-Nam University, Daegu, Republic of Korea. He joined the Electrical Engineering Department of Kyungnam University, Masan, Republic of Korea, in 1983 as a professor. He

was a visiting professor of Virginia Polytechnic Institute and State University, USA in 1997. His research interests include application developments of power electronics circuits and system. He is a member of the KIEE and KIPE.

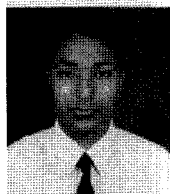

Bishwajit Saha received his B.Sc. degree in Electrical and Electronic Engineering in 2004 from Dhaka University of Engineering & Technology, Bangladesh. He received his M. Sc. degree in the Department of Electrical Engineering, Kyungnam University, Masan,

Republic of Korea. His research interests and research development includes DC-DC power converter topologies, high frequency inverters applications and renewal energy related power conditioner. He is a student member of IEEE and member of

IEB-Bangladesh.



Sang-Pil Mun received his B.S. degree in Electrical Engineering from Pukyong University, Pusan, Korea in 1997 and M.S. and Ph.D. degrees in Electrical Engineering from Kyungnam University, Masan, Korea in 1999 and 2003 respectively. He joined the Electrical Energy Saving Research Center (EESRC), Kyungnam University from 2003~2005 as a researcher. Since 2006 he is an interim full-time instructor in the Department of Electrical Engineering, Kyungnam University. His research interests are in the areas of photovoltaic power generation systems, power electronics, and soft-switching technology. He is a member of the KIEE, KIPE, KIIEE.



Kazunori Nishimura was born in Ehime, Japan, 1965. He received his B.S. from the Department of Electronics Engineering, Yamaguchi University. He received his M.E. and Doctor of Information Engineering degree from the Department of Information Systems,

Hiroshima City University, Japan. Now he is an associate professor in the Hiroshima Institute of Technology, Japan. His current research interests are in Modern Power Electronics; Soft-switching Technique for High frequency Power Conversion systems.



Mutsuo Nakaoka received his Ph.D. degree in Electrical Engineering from Osaka University, Osaka, Japan in 1981. He joined the Electrical and Electronics Engineering Department of Kobe University, Kobe, Japan in 1981 and served as a professor in the

Department of Electrical and Electronics Engineering, The Graduate School of Engineering, Kobe University, Kobe, Japan. Since 1995, he has been a professor of the Electrical and Electronics Engineering Department, the Graduate School of Science and Engineering, Yamaguchi University, Yamaguchi, Japan and Hyogo College of Industrial Technology, Hyogo, Japan. His research interests include application developments of power electronics circuits and systems. Prof. Dr.-Eng. Nakaoka received the 2001 Premium Prize Paper Award from IEE-UK, 2001/2003 IEEE-IECON Best Paper Award, the third paper award in 2000 IEEE-PEDS, 2003 IEEE-IAS James Melcher Prize Paper Award, Best Paper Award of International Appliance Technical Conference. He is now a chairman of the IEEE Industrial Electronics Society Japan Chapter. He is an active member of the, IEE-J, IEICE-J, Solar Energy Institute of Engineers, European Power Electronics Association, IEIE-J, KIPE, JIPE and IEEE.