

Spatial Multiuser Access for Reverse Link of Multiuser MIMO Systems

Oh-Soon Shin* *Regular Member*

ABSTRACT

Spatial multiuser access is investigated for the reverse link of multiuser multiple-input multiple-output (MIMO) systems. In particular, we consider two alternative approaches to spatial multiuser access that adopt the same detection algorithm at the base station: one is a closed-loop approach based on singular value decomposition (SVD) of the channel matrix, whereas the other is an open-loop approach based on space-time block coding (STBC). We develop multiuser detection algorithms for these two spatial multiuser access schemes based on the minimum mean square error (MMSE) criterion. Then, we compare the bit error rate (BER) performance of the two schemes and a single-user MIMO scheme. Interestingly, it is found that the STBC approach can provide much better BER performance than the SVD approach as well as than a single-user MIMO scheme.

Key Words : Minimum mean square error (MMSE), Multiple-Input multiple-output (MIMO), Singular value decomposition (SVD), Space-time block coding (STBC), Spatial multiuser access

I. Introduction

Multiple-input multiple-output (MIMO) systems have received considerable attention as a means for achieving high data rate over wireless links^[1]. Various space-time processing architectures such as Bell Laboratories Layered Space-Time (BLAST) and space-time coding have been proposed to approach the theoretical capacity limit of MIMO systems^{[1]-[3]}. Most of these architectures have been designed to increase the data rate or improve the performance of a single user communication link, using spatial multiplexing and diversity techniques. However, most of wireless systems should accommodate multiple users, and the presence of multiple users causes co-channel interference (CCI). Traditional approach to handling CCI from multiple users is to adopt an orthogonal signaling scheme, such as time division multiple access (TDMA) and code division multiple access (CDMA). In MIMO systems, multiple transmit and receive antennas allow the space dimension to be used

for suppressing CCI as well as for achieving diversity gain. This motivates developments of effective spatial multiuser access schemes that can exploit the space dimension for accommodating multiple users in MIMO systems.

Two alternative approaches have been proposed for effective spatial multiuser access for multiple access channels or the reverse link of multiuser MIMO systems^{[4]-[6]}. In [4], a spatial multiuser access scheme has been proposed based on singular value decomposition (SVD) of channel matrices. This scheme separates the signals of multiple transmitting users in the space domain through the use of transmit and receive spatial processing based on SVD and multiuser detection. A similar approach has been presented in [5], where transmit and receive spatial filters are jointly optimized to maximize the signal-to-interference-plus-noise ratio (SINR) of all users. These schemes of [4] and [5] require closed-loop operation, since they need the channel state information at both the transmitters and receiver. Another approach in [6]

* 본 연구는 숭실대학교 교내연구비 지원으로 이루어졌음.

* 숭실대학교 정보통신전자공학부(ossin@ssu.ac.kr)

논문번호 : KICS2008-01-042, 접수일자 : 2008년 1월 21일, 최종논문접수일자 : 2008년 9월 19일

is an open-loop scheme based on space-time block coding (STBC), which eliminates the need for channel state information at the transmitters. Transmit antennas at each user terminal are independently utilized for space-time block coding (STBC) of transmit signals to achieve transmit diversity. The receive antennas are exploited to suppress CCI from multiuser signals using a multiuser detection technique.

For fair assessment of the SVD and STBC approaches, we develop a multiuser detector for each of the two approaches, based on a common criterion, minimum mean square error (MMSE). The SVD and STBC transmit processing schemes with a corresponding MMSE multiuser detector will be referred to as SVD-MMSE and STBC-MMSE schemes, respectively. To develop the STBC-MMSE scheme, in particular, we consider full rate STBCs for two and four transmit antennas presented in [7] and [8]. The bit error rate (BER) performance of the multiuser access schemes is compared with that of a single-user spatial multiplexing scheme called MMSE-BLAST [2]. Simulation results show that the STBC-MMSE scheme provides significant BER reduction over the MMSE-BLAST scheme, and achieves the greatest diversity gain among the three schemes. Moreover, the STBC-MMSE scheme is also found to outperform even the SVD-MMSE scheme for a wide range of signal-to-noise ratio (SNR), especially for the large number of simultaneous users.

The remainder of this paper is organized as follows. Section II describes the reverse link of a multiuser MIMO system and channel models. In Section III, we derive the SVD-MMSE and STBC-MMSE spatial multiuser access schemes. In Section IV, simulation results are presented to compare the performance of the SVD-MMSE and STBC-MMSE with that of MMSE-BLAST. Finally, conclusions are drawn in Section V.

II. System and Channel Models

The reverse link of a multiuser MIMO system is considered in this paper. As illustrated in Fig. 1, each mobile station or user terminal is equipped with N_T transmit antennas, and the base station is equipped

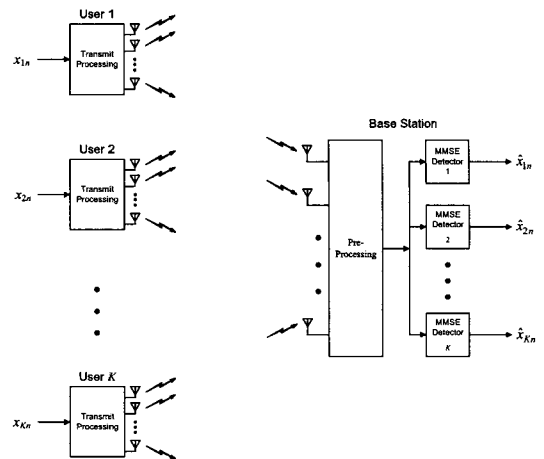

Fig. 1. Reverse link of a multiuser MIMO system

with N_R receive antennas. It is assumed that K users transmit signals simultaneously through individual N_T transmit antennas, and that the transmit signals experience uncorrelated frequency- nonselective fading. Let s_{kn} be an $N_T \times 1$ transmit signal vector for the k th user at the n th symbol duration, with each element being normalized to have unit average power. The corresponding received signal vector at the base station can be expressed as

$$\mathbf{r}_n = \sum_{k=1}^K \mathbf{H}_{kn} \mathbf{s}_{kn} + \mathbf{w}_n, \quad (1)$$

where \mathbf{H}_{kn} is an $N_R \times N_T$ channel matrix from the k th user to the base station for the n th symbol duration, and it is assumed that all elements of \mathbf{H}_{kn} are independent and identically distributed (i.i.d.) complex Gaussian random variables with zero mean and unit variance. Elements of $N_R \times 1$ noise vector \mathbf{w}_n at the n th symbol duration are assumed to be i.i.d. complex Gaussian random variables with zero mean and variance of σ^2 .

III. Spatial Multiuser Access

In this section, we derive the SVD-MMSE and STBC-MMSE spatial multiuser access schemes. For the SVD-MMSE scheme, we describe the SVD operation needed for constructing transmit signal vector and an MMSE multiuser detection algorithm in [4]. For the STBC-MMSE scheme, we describe the STBC

used for each user terminal, and develop an MMSE multiuser detection algorithm for the base station. We present derivations for two and four transmit antenna cases for rate one STBCs in [7] and [8]. However, the derivation procedure may be easily applied to other number of transmit antennas or to other forms of STBC. We assume that the channel is constant during each symbol for the SVD-MMSE and during each space-time code block for the STBC-MMSE. With this assumption, we will omit the symbol index n in the subsequent derivations, whenever it does not make any confusion.

3.1 SVD-MMSE

The channel matrix H_k can be decomposed using SVD as

$$H_k = \sum_{i=1}^{\min(N_T, N_R)} u_{ki} \lambda_{ki} v_{ki}^H, \quad (2)$$

where λ_{ki} is a singular value of H_k , u_{ki} and v_{ki} are corresponding unitary vectors, and $(\cdot)^H$ denotes the conjugate transpose operation. The SVD-MMSE scheme uses v_{ki} and u_{ki} associated to the maximum singular value as transmit filter and receive matched filter, respectively^[4]. Let λ_k be the maximum singular value for the k th user, and let v_k and u_k be the corresponding unitary vectors. The transmit signal vector is formed as $s_k = v_k x_k$, where x_k denotes the transmit symbol of the k th user. By matched filtering for the k th user, the received signal in (1) is processed as

$$y_k = u_k^H r = u_k^H \left(\sum_{j=1}^K H_j s_j + w \right) = \sum_{j=1}^K u_k^H u_j \lambda_j x_j + z_k, \quad (3)$$

where $z_k = u_k^H w$. From (3), the signals for all K users can be written in a vector form as

$$y = \Phi \Lambda x + z, \quad (4)$$

where $y = [y_1 \ y_2 \ \dots \ y_K]^T$, $x = [x_1 \ x_2 \ \dots \ x_K]^T$, $z = [z_1 \ z_2 \ \dots \ z_K]^T$, $\Lambda = \text{diag}(\lambda_1, \lambda_2, \dots, \lambda_K)$, and $(\cdot)^T$ denotes the transpose operation. The matrix Φ in (4) is a $K \times K$ matrix whose (i, j) element is defined as $[\Phi]_{ij} = u_i^H u_j$. From (4), the MMSE multiuser detection rule can be derived as

$$\hat{x} = \Lambda^{-1} (\Phi + \sigma^2 \Lambda^{-2})^{-1} y. \quad (5)$$

3.2 STBC-MMSE

In an STBC-MMSE scheme, STBC is performed on a data stream to construct transmit signals for each user. Let r be the code rate of STBC, then N_T/r symbol durations form a space-time code block.

1) *Case of Two Transmit Antennas ($N_T = 2$):* For two transmit antennas, a rate one orthogonal STBC has been presented in [7]. This STBC is known to provide full diversity gain without rate reduction. In the STBC, two transmit symbols are encoded across space and time, and a code block C can be expressed in a matrix form as

$$C = [c_1 \ c_2] = \begin{bmatrix} x_1 & -x_2^* \\ x_2 & x_1^* \end{bmatrix}, \quad (6)$$

where x_1 and x_2 denote two transmit symbols. Note that columns of C are associated with time domain, and rows of C with space domain or transmit antennas. That is, $c_1 = [x_1 \ x_2]^T$ is transmitted over the first symbol duration of a code block, and $c_2 = [-x_2^* \ x_1^*]^T$ over the second one. Transmit signal vectors of each user are constructed according to this rule. Hence, the transmit signal vectors s_{k1} and s_{k2} in (1) for the k th user can be expressed as

$$s_{k1} = [x_{k1} \ x_{k2}]^T, \quad s_{k2} = [-x_{k2}^* \ x_{k1}^*]^T, \quad (7)$$

where x_{k1} and x_{k2} denote transmit symbols for the k th user. Note that this transmission scheme is equivalent to double space-time transmit diversity (D-STTD) developed for four transmit antennas of a single user^[8].

MMSE detection is performed on the received signal vectors without any pre-processing, differently from the SVD-MMSE. For the MMSE detection, r_1 and r_2 in (1) are concatenated to construct a composite $2N_R \times 1$ received signal vector R as

$$R \equiv [r_1; r_2] = \sum_{k=1}^K G_k S_k + W, \quad (8)$$

where

$$G_k \equiv \text{diag}(H_k, H_k^*), \quad S_k \equiv [s_{k1}; s_{k2}^*], \quad W \equiv [w_1; w_2^*]. \quad (9)$$

In (8) and (9), notation $[v_1; v_2; \dots; v_N] = [v_1^T \ v_2^T \ \dots \ v_N^T]^T$ denotes the concatenation of N column vectors, and $\text{diag}(M_1, M_2, \dots, M_N)$ is a block diagonal matrix with N matrices forming diagonal blocks. The operation $(\cdot)^*$ in (8) and (9) for a matrix or vector represents complex conjugates of all elements. The reason for taking complex conjugates of r_2 in constructing R in (8) is to make all the components of S_k become linear combinations of x_{k1} and x_{k2} , which should be estimated using linear operations. From (8), the transmit symbol vectors $s_{k1} = [x_{k1} \ x_{k2}]^T$ ($k=1, 2, \dots, K$) can be estimated using linear operations. A weight vector T_k for estimating s_{k1} in the MMSE sense is given as the solution of a minimization problem:

$$T_k = \arg \min_T E[\|s_{k1} - TR\|^2], \quad (10)$$

which can be solved as

$$\begin{aligned} T_k &= E[s_{k1} R^H] (E[RR^H])^{-1} \\ &= E[s_{k1} S_k^H] G_k^H \left(\sum_{k=1}^K G_k E[S_k S_k^H] G_k^H + E[WW^H] \right)^{-1}, \end{aligned} \quad (11)$$

where $E[\cdot]$ denotes the statistical expectation. Correlation matrices $E[s_{k1} S_k^H]$, $E[S_k S_k^H]$, and $E[WW^H]$ in (11) can be computed using (7) and (9) as

$$E[s_{k1} S_k^H] = \begin{bmatrix} 1 & 0 & 0 & 1 \\ 0 & 1 & -1 & 0 \end{bmatrix}, \quad (12)$$

$$\begin{aligned} E[S_k S_k^H] &= \begin{bmatrix} 1 & 0 & 0 & 1 \\ 0 & 1 & -1 & 0 \\ 0 & -1 & 1 & 0 \\ 1 & 0 & 0 & 1 \end{bmatrix}, \\ E[WW^H] &= \sigma^2 I_{2N_r} \end{aligned}$$

which are independent of the user index k . Consequently, the MMSE estimate of the transmit symbol vector s_{k1} is found as

$$\widehat{s}_{k1} = T_k R. \quad (13)$$

2) *Case of Four Transmit Antennas* ($N_T = 4$): For four transmit antennas, an orthogonal rate one STBC does not exist for complex signal constellations. To preserve the rate one property, we employ a quasi-or-

thogonal rate one STBC presented in [9]. With the same notations as in (6), a code block for this STBC can be represented as

$$C = [c_1 \ c_2 \ c_3 \ c_4] = \begin{bmatrix} x_1 & -x_2^* & -x_3^* & x_4 \\ x_2 & x_1^* & -x_4^* & -x_3 \\ x_3 & -x_4^* & x_1^* & -x_2 \\ x_4 & x_3^* & x_2^* & x_1 \end{bmatrix}, \quad (14)$$

where c_n is the transmit symbol vector transmitted over the n th symbol duration of the code block. Hence, the transmit signal vectors s_{k1} , s_{k2} , s_{k3} , and s_{k4} in (1) for the k th user can be expressed as

$$\begin{aligned} s_{k1} &= [x_{k1} \ x_{k2} \ x_{k3} \ x_{k4}]^T, \\ s_{k2} &= [-x_{k2}^* \ x_{k1}^* \ -x_{k4}^* \ x_{k3}^*]^T, \\ s_{k3} &= [-x_{k3}^* \ -x_{k4}^* \ x_{k1}^* \ x_{k2}^*]^T, \\ s_{k4} &= [x_{k4} \ -x_{k3} \ -x_{k2} \ x_{k1}]^T. \end{aligned} \quad (15)$$

For the MMSE detection, r_1 , r_2 , r_3 and r_4 in (1) are concatenated to construct a composite $4N_r \times 1$ received signal vector R as

$$R = [r_1; r_2; r_3; r_4] = \sum_{k=1}^K G_k S_k + W, \quad (16)$$

where

$$\begin{aligned} G_k &= \text{diag}(H_k, H_k^*, H_k^*, H_k), \\ S_k &= [s_{k1}; s_{k2}; s_{k3}; s_{k4}], \\ W &= [w_1; w_2; w_3; w_4]. \end{aligned} \quad (17)$$

The MMSE weight vector T_k for estimating s_{k1} can be expressed as the same form as (11). Correlation matrices $E[s_{k1} S_k^H]$, $E[S_k S_k^H]$, and $E[WW^H]$ in this case can be computed using (15) and (17) as

$$\begin{aligned} E[s_{k1} S_k^H] &= [A \ B \ C \ D], \\ E[S_k S_k^H] &= \begin{bmatrix} A & B & C & D \\ -B & A & -D & C \\ -C & -D & A & B \\ D & -C & -B & A \end{bmatrix}, \\ E[WW^H] &= \sigma^2 I_{4N_r} \end{aligned} \quad (18)$$

where

$$A = \begin{bmatrix} 1 & 0 & 0 & 0 \\ 0 & 1 & 0 & 0 \\ 0 & 0 & 1 & 0 \\ 0 & 0 & 0 & 1 \end{bmatrix}, B = \begin{bmatrix} 0 & 1 & 0 & 0 \\ -1 & 0 & 0 & 0 \\ 0 & 0 & 0 & 1 \\ 0 & 0 & -1 & 0 \end{bmatrix}, \quad (19)$$

$$C = \begin{bmatrix} 0 & 0 & 1 & 0 \\ 0 & 0 & 0 & 1 \\ -1 & 0 & 0 & 0 \\ 0 & -1 & 0 & 0 \end{bmatrix}, D = \begin{bmatrix} 0 & 0 & 0 & 1 \\ 0 & 0 & -1 & 0 \\ 0 & -1 & 0 & 0 \\ 1 & 0 & 0 & 0 \end{bmatrix}.$$

IV. Numerical Results

In this section, the performance of the SD-MMSE and STBC-MMSE is compared with each other and with that of the MMSE-BLAST. The transmit symbols of all users are assumed to be modulated using quaternary phase shift keying (QPSK), and Monte Carlo simulations are conducted to estimate bit error rate (BER) performance of each scheme. The MMSE-BLAST is simulated using equations in [2] with MMSE nulling. It is assumed that the channel response is perfectly known to the transmitters and receiver for the SVD-MMSE scheme, but only to the receiver for the STBC-MMSE and MMSE-BLAST schemes. We use (N_T, N_R) to denote a MIMO system with N_T transmit antennas at each user terminal and N_R receive antennas at the base station. The SNR in each plot is defined as N_T/σ^2 , which is the ratio of the total received signal power to the noise power.

Fig. 2 shows the BER performance for a (2, 2) MIMO system. For the single user system ($K=1$), the SVD-MMSE scheme is shown to outperform the STBC-MMSE scheme due to beamforming gain from the closed-loop operation. Note that the overall data rate of MMSE-BLAST scheme is the same as those of STBC-MMSE and SVD-MMSE schemes with $K=2$. For the given range of SNR, both STBC-MMSE and SVD-MMSE schemes outperform the MMSE-BLAST. When $K=2$, the BER curve of STBC-MMSE scheme is steeper than that of SVD-MMSE scheme, and two curves are crossing around SNR = 10 dB. This indicates that the

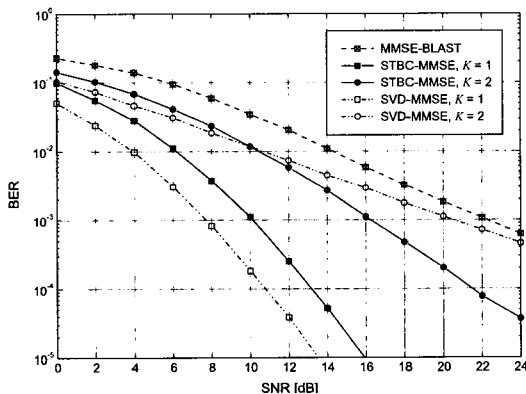

Fig. 2. BER performance for a (2, 2) MIMO system

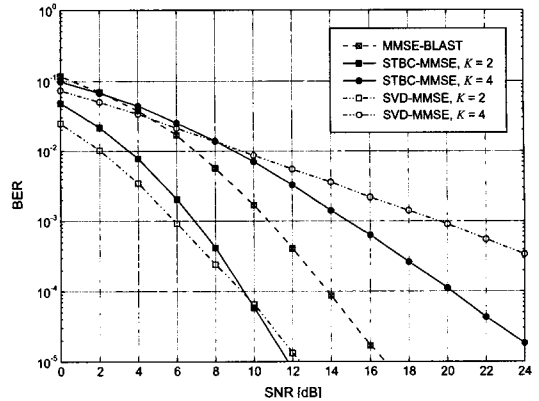

Fig. 3. BER performance for a (2, 4) MIMO system

STBC-MMSE scheme achieves greater diversity order than the SVD-MMSE scheme at the same transmission rate, since the slope of BER curve stands for the diversity order. This also implies that it is more effective to maximize diversity at each transmitter rather than to perform beamforming in the spatial multiuser access scenarios. The SNR gains of STBC-MMSE for $K=2$ are about 6 dB over MMSE-BLAST and 4 dB over SVD-MMSE at BER of 10^{-3} . Fig. 3 shows the BER performance for a (2, 4) MIMO system. Comparing Fig. 2 and Fig. 3 for the case of $K=2$, a (2, 4) system is shown to provide much lower BER than a (2, 2) system, due to two more degrees of freedom in the receive antenna dimension. For $K=2$, the STBC-MMSE scheme outperforms the SVD-MMSE scheme for the SNR greater than 10 dB. The BER plots for $K=4$ verify that the STBC-MMSE and SVD-MMSE can accommodate simultaneous transmissions of users up to the number of receive antennas. When $K=4$, the STBC-MMSE scheme is shown to outperform the SVD-MMSE scheme as much as 5 dB at BER of 10^{-3} .

The BER performance for a (4, 4) MIMO system is shown in Fig. 4. Similar performance trends are observed as in Fig. 2. The crossing points of the BER curves for the STBC-MMSE and SVD-MMSE schemes are also near SNR = 10 dB. The MMSE-BLAST scheme in this case has the same overall data rate with the STBC-MMSE and SVD-MMSE schemes with $K=4$. When $K=4$, the STBC-MMSE scheme achieves about 4 dB of SNR

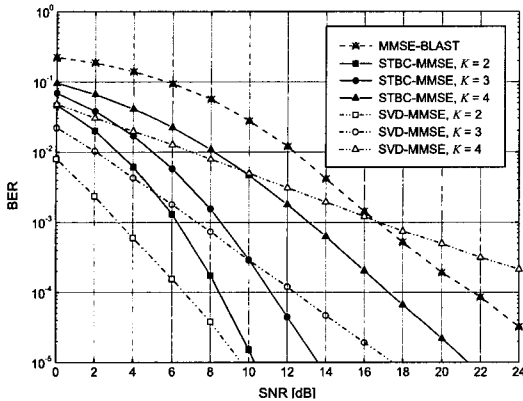

Fig. 4. BER performance for a (4, 4) MIMO system

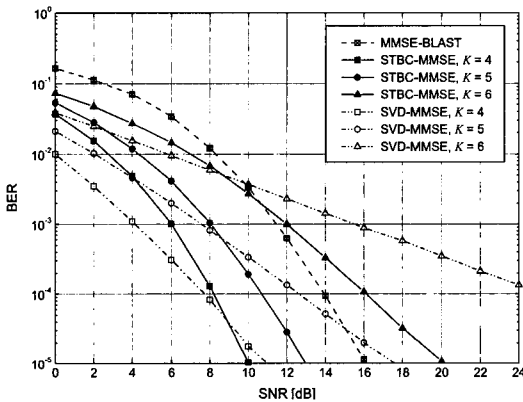

Fig. 5. BER performance for a (4, 6) MIMO system

gain compared with the SVD-MMSE and MMSE-BLAST schemes. Fig. 5 shows the BER performance for a (4, 6) MIMO system. In this case, the crossing points of the BER curves for the STBC-MMSE and SVD-MMSE schemes are near SNR = 9 dB. The STBC-MMSE scheme for $K=6$ is shown to provide a diversity order comparable to the SVD-MMSE scheme for $K=4$. The performance improvement of the STBC-MMSE scheme over the SVD-MMSE scheme is shown to increase with the number of users. When $K=6$, the STBC-MMSE scheme outperforms the SVD-MMSE scheme as much as 3.5 dB at BER of 10^{-3} .

Fig. 6 shows the BER performance for a (2, 2) MIMO system, when the three transmission schemes use the maximum-likelihood (ML) detection instead of the MMSE. The number of users K is set to 2 for the two multiuser access schemes. We can observe

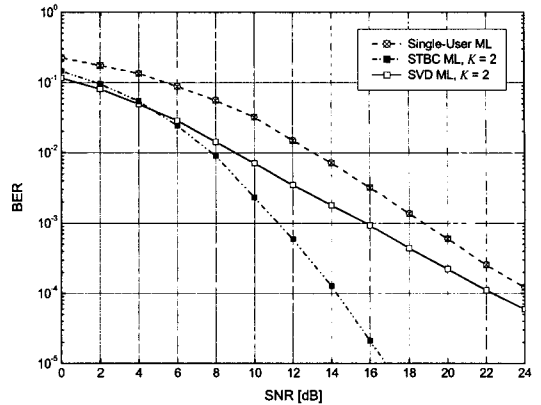

Fig. 6. BER performance for a (2, 2) MIMO system with ML detection

similar performance trends as in the case of the MMSE detection in Fig. 2.

V. Conclusions

In this paper, spatial multiuser access schemes have been investigated for the reverse link of multiuser MIMO systems. In particular, we have considered a closed-loop scheme, referred to as SVD-MMSE, and an open-loop scheme, referred to as STBC-MMSE. For the STBC-MMSE scheme, we have derived MMSE multiuser detectors for full rate STBCs with two and four transmit antennas. The performance of the SVD-MMSE and STBC-MMSE has been compared with each other and with that of the single-user MMSE-BLAST. Simulation results have shown that the STBC-MMSE can significantly outperform the SVD-MMSE as well as the MMSE-BLAST, especially for the large number of simultaneous users. The STBC-MMSE scheme has also been found to achieve the greatest diversity order among the three schemes at the same transmission rate. For instance, the SNR gain of the STBC-MMSE over the SVD-MMSE at the BER of 10^{-3} is shown to be about 5 dB for a (2, 4) MIMO system with four users, and 3.5 dB for a (4, 6) MIMO system with six users.

References

- [1] G. J. Foschini and M. J. Gans, "On limits of wireless communications in a fading environ-

- ment when using multiple antennas,” *Wireless Personal Commun.*, Vol.6, pp.315-335, Mar. 1998.
- [2] P. W. Wolniansky, G. J. Foschini, G. D. Golden, and R. A. Valenzuela, “V-BLAST: An architecture for realizing high data rates over the rich-scattering wireless channel,” in *Proc. URSI Int. Symp. Signals, Systems, and Electronics*, Pisa, Italy, Sept.-Oct. 1998, pp.295-300.
- [3] V. Tarokh, N. Seshadri, and A. R. Calderbank, “Space-time codes for high data rate wireless communication: performance criterion and code construction,” *IEEE Trans. Inform. Theory*, Vol.44, pp.744-765, Mar. 1998.
- [4] J. Kim and J. M. Cioffi, “Spatial multiuser access with antenna diversity using singular value decomposition,” in *Proc. IEEE Inter. Conf. Commun. (ICC)*, New Orleans, LA, USA, June 2000, pp.1253-1257.
- [5] J. Li, K. B. Letaief, Z. Ma, and Z. Cao, “Spatial multiuser access with MIMO smart antennas for OFDM systems,” in *Proc. IEEE Veh. Technol. Conf. (VTC) Fall*, Atlantic City, NJ, USA, Oct. 2001, pp.1553-1557.
- [6] A. F. Naguib, N. Seshadri, and A. R. Calderbank, “Application of space-time block codes and interference suppression for high capacity wireless systems,” in *Proc. Asilomar Conf. Signals, Systems, and Computers*, Pacific Grove, CA, USA, Nov. 1998, pp.1803-1810.
- [7] S. M. Alamouti, “A simple transmit diversity technique for wireless communications,” *IEEE J. Select. Areas Commun.*, Vol.16, pp.1451-1458, Oct. 1998.
- [8] Texas Instruments, “Double-STTD scheme for HSDPA systems with four transmit antennas: link level simulation results,” TSGR1#20(01) 0458, May 2001.
- [9] H. Jafarkhani, “A quasi-orthogonal space-time block code,” *IEEE Trans. Commun.*, Vol.49, pp.1-4, Jan. 2001.

신 오 순 (Oh-Soon Shin)

정회원

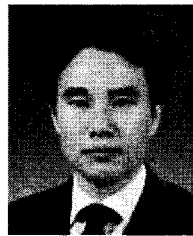

1998년 2월 서울대학교 전기공학
부 학사

2000년 2월 서울대학교 전기공학
부 석사

2004년 2월 서울대학교 전기 컴
퓨터공학부 박사

2004년 3월~2005년 9월 Harvard
Univ. 박사후연구원

2006년 4월~2007년 8월 삼성전자 통신연구소 책임연
구원

2007년 9월~현재 숭실대학교 정보통신전자공학부
전임강사

<관심분야> 통신이론, 통신시스템, 통신신호처리