

# Hospital Emergency Department Simulation for Resource Analysis

**Erhan Kozan<sup>†</sup>**

School of Mathematical Sciences  
Queensland University of Technology  
GPO Box 2434 Brisbane, Qld 4001, AUSTRALIA  
+617-3864 1029, Email: e.kozan@qut.edu.au

**Mel Diefenbach**

School of Mathematical Sciences  
Queensland University of Technology  
GPO Box 2434 Brisbane, Qld 4001, AUSTRALIA  
+617-3864 1029, Email: m.diefenbach@student.qut.edu.au

Selected paper APIEMS2006

**Abstract.** The Emergency Department (ED) is an integral part of hospitals. Admissions from the ED account for a significant proportion for a hospital's activity. Ensuring a timely and efficient flow of patients through the ED is crucial for optimising patient care. In recent years, ED overcrowding and its impact on patient flow has become a major issue facing the health sector. Simulation is rapidly becoming a tool of choice when examining hospital systems due to its capacity to involve numerous factors and interactions that impact the system. An analytical simulation model is used to investigate potential impacts by changing the following aspects of ED (physical layouts; number of beds; number and rate of patient arrivals; acuity of illness or injury of patients; access to radiology and pathology services; hospital staffing arrangements; and access to inpatient beds). Results of a significant numerical investigation at a hospital are also presented.

**Keywords:** Health Care Systems, Simulation, Emergency Department.

## 1. INTRODUCTION

The role of the Emergency Department has been changing over the last two decades as described by the Wellness Institute (2005). The treatments that the ED provides have been increasing over recent years. In 2002–2003, more than 3.8 million Australians went to an emergency department for treatment—10 per cent more than in 1998–1999. Triage is the assessment of a patient's urgency for medical treatment and there were significant variations in the percentage change in emergency department attendances by triage category. Nationally, attendances in triage categories 1, 2, 3 and 4 increased (by 2%, 45%, 24% and 5%, respectively), while triage category 5 attendances decreased by 11%. (Department of Health and Ageing (2005). These changes have increased the overall treatment times. However, number of beds has been decreased during this period and resulted with unexpected congestions in ED.

Specific elements along the path that patients follow

include some or all of the following stages: arrival; triage; record retrieval; physician assessment; imaging and laboratory studies; x-rays or medical resonance imaging; treatment planning; nursing activity; procedures (e.g. suturing and casting); decision to discharge or admit; access to inpatient beds and physicians. These stages generally occur in a sequential manner. Process delay at the one stage of patient flow in ED can have a significant impact on patient throughput and caused the bottlenecking of patients exiting the system. The positive flow of patients through the ED is affected by a variety of factors. Often there is an inability for patients to enter the system as a result of other patients already in the system being unable to exit, due to the interaction and dependence on other systems (within and external to the hospital), and the availability of resources to the ED.

The use of simulation to study aspects of hospital activities has been well documented in literature. Although the following outline is not exhaustive, it does highlight several issues in a hospital to which the method of simu-

---

<sup>†</sup> : Corresponding Author

lation can be applied. Hancock *et al.* (1978), S. McClean and Millard (1995) and G. Vassilacopoulos (1985) used simulation to examine the problem of capacity and bed management in hospitals. Cote (1999) used a discrete event simulation model to investigate the relationship between examining room capacity and patient flow, and Alessandra *et al.* (1978) examined patient flow to consider the effect changes on staffing and operational procedures had on queues in a family clinic. Blake *et al.* (1996) studied the Emergency Room and the issues contributing to waiting times, and Badri and Hollingsworth, (1992) also examined the Emergency Room, looking at the effect changes in operational procedures and staffing had on performance.

Almost all real-world systems will involve some sort of random variation. Deterministic models choose to ignore this and assume it does not affect the decision to be made, whereas stochastic models attempt to take random variation into account. Gove and Hewett (1995) examined the problem of capacity in hospitals and due to the complexity of the hospital and its departments, simulation was an ideal choice. A stochastic model was decided on, with simulation being the best method to represent the hospital and its variation. Vassilacopoulos (1985) also found simulation to be the most appropriate technique to determine bed occupancy in an in-patient department to meet a pre-determined demand for service.

Patient waiting time is also important when examining hospitals and their efficiency. Huang *et al.* (1995) used simulation to reduce the waiting time for a consultation and the length of treatment time in an Emergency Room. The scheduling and utilisation of current staff was examined with the aim of reducing waiting to desirable standards. The Emergency Department is a good example of a queuing system where patients must wait for various resources (i.e. doctors, nurses or X-ray equipment) to become available. However, although it is a good example, queuing theory cannot be used because of the complexity of the system. Hence computer simulation is a preferable choice to represent it.

A study by Kozan and Gillingham (1997) also used simulation to change parameters to find a solution to meet desired levels. Two ways to approximate an ideal solution of no patients waiting and total resource availability were examined.

Patients awaiting ambulance for discharging is a particularly a problem in Australia as shown by the Australasian College for Emergency Medicine (see Knox 2004). Schriver *et al.* (2003) showed that shortage of staff in the Emergency Department impacts the ability of the system to flow. Sometimes, surgery blocks scheduled by surgeons cause irregularities and spikes in intensive care unit bed usage, triggering bottlenecks in the ED (see Barnard 2002). Emergency Departments are being flooded with people seeking treatment for nonurgent conditions as well. People are using Emergency Departments as their usual source of care or simply to get a second opinion (see Sarver *et al.* (2002)).

Some of the situations that may hinder the flow are able to be controlled and managed within the Emergency Department and others are well outside the control of the Emergency Department and an optimal solution must be achieved by trying to minimize the impact of these affecting processes and working within the confines.

There are a number of propositions and research into overcrowding within Emergency Departments and several suggestions as to the improvement of these systems. There are alternate reasons for hospital management to desire an improvement in the flow of the Emergency Department, including financial gain, smoother running of the hospital, and a less stressful and pressured environment for staff. Gonzalez-Martinez *et al.* (1997) offers computer software to assist in increasing the quality of service in an ED.

Technology can be employed in a variety of ways to increase patient care and simultaneously reduce waiting and service times. Nozar (2003) reports on automation of the consultation process specifically and its beneficial input to patient care. It allows physicians to focus on patient care by reducing paperwork and enables patients to be more informed. New South Wales Health (2001) is committed to ensuring effective discharge. The discharge from an inpatient bed as soon as that decision is made that helps increase the flow of patients through the entire hospital, including the Emergency Department. Bagust *et al.* (1999) used a simulation model to model a hospital and determine occupancy rates that would pose considerable risk to patients requiring immediate admission. McHardy *et al.* (2005) and (2004) have developed a simulation model to measure efficiency of ICU.

The performance can be measured by one or more of the following performance indicators: waiting time; post discharge decision time; use of ambulance diversion, bed utilization and access block. The Australasian College for Emergency Medicine -ACEM- (2000) has waiting time performance indicator thresholds for Australian Emergency Departments to meet. The EDs are expected to attain at least the levels indicated for percentage of patients seen within the guidelines for waiting times.

## 2. COMPLEXITY OF THE PROBLEM

The following characteristics of the system make the problem complex and unique:

- the arrival, diagnosis and treatment of patients are unscheduled and there is no option to not treat an arriving patient. There is no prior knowledge of patterns of the arriving patients that will be requiring treatment in the ED in a given period of time;
- the assignment of the next arrival to enter the system is determined by a priority rule. Patients are triaged and seen according to need. ACEM (2000) and ACEM (2001) give the Australasian Triage Scale and the recommended maximum time between arrival in the ED queue and the commence-

ment of treatment. The assumption is that if these patients are not seen within this time their condition will degenerate requiring further time in the system when they are finally treated;

- the times waiting for each stage in the ED are also critical to optimise the system. Staffing resources queues are priority based allowing pre-emption, that is, patient treatment may be interrupted for treatment of a higher priority with the intent of returning to complete treatment; and
- accurate data is required for the flow of each patient through the Emergency Department. The path that a patient would follow with specific presenting symptoms is different for each patient (see Connelly and Bair (2004) for details).

The complexity of the model is increased by the decisions of how to model the patient characteristics at each stage. Due to the number of ways a patient could be split into categories (triage, presenting condition, diagnosis) each decision process had a number of options. For example it has been common thought that treatment times are based on triage category however it is proposed that by including the diagnosis in the determination of treatment times the result is more accurate and allows more detailed treatment paths to be modelled.

### 3. SIMULATION MODEL

Analytical models cannot easily represent the complex interactions caused by random events. Simulation is one of the most powerful analysis tools available for operation and the design of complex systems. The simulation model is developed for the purpose of understanding the behaviour of the emergency arrivals and/or evaluating various strategies for the operation of the call centres. The relationships among system's elements and the manner in which they interact determine how the overall system behaves and how well it fulfils its overall purpose (Pidd, 1996).

Some of the probability distributions may not be standard probability distributions like those used in queuing theory and other mathematical models; however, simulation allows us to include these non-standard distributions into the model. The potential for sensitivity analysis is almost limitless, so we investigate what improvements can be made to any bottlenecks if we have any and vary key parameters, such as the arrival times and service times.

This paper describes a simulation-based approach that allows Emergency Departments to more quickly develop, test, and refine robust plans for an ever increasing list of potential threats. The expectation of the computer simulation environment is to give Emergency Department planners a reference model to analyse risks, facilitate the coordination implementation and allocation of resources, identify weaknesses in service of resources.

Data was collected from existing information systems within the ED for 12 months. This resulted in 42,238 usable data points with 0.9776% being eliminated due to incorrect or missing data.

A simulation software (Extend V6, 2002) is used for developing the model and analysing the results. It contains a simple interface with predesigned 'blocks' being used to piece together the model. Simulation model statements of Extend are called blocks. Blocks define how the system operates. These 'blocks' consists of multiple queue types and variable adjustments which greatly simplifies the construction of a large simulation model. Each time a block is executed, the state of the system is changed. When a block is executed, an object called an entity must pass through the block. Entities typically represent items moving through the system such as patients. Similarly, a block's function normally corresponds to an operation in the real system. For example, consider the resource block: when an entity executes this block, resources (bed, doctors, etc.) are assigned to the entity in much the same manner as resources are assigned to a emergency call.

Specific elements along the path that patients follow include some or all of the following stages: arrival; triage; history taking/record retrieval; physician assessment; imaging and laboratory studies; x-rays or medical resonance imaging; treatment planning; nursing activity; procedures (e.g. suturing and casting); decision to discharge or admit; access to inpatient beds and physicians. These stages generally occur in a sequential manner. Process delay at the one stage can have a significant impact on patient throughput and caused the bottlenecking of patients exiting the system.

The positive flow is also affected by the followings: unable to release patients already in the system because of awaiting ambulance transfer; shortage of staff, surgery blocks scheduled by surgeons; people seeking treatment for non-urgent conditions; people are using Emergency Departments as their usual source of care or simply to get a second opinion. An optimal solution must be achieved by trying to minimize the impact of these affecting processes and working within the confines.

Therefore, simulation model is used to:

- examine hospital systems due to its capacity to involve a number of variables and interactions that impact the system;
- find problems that may arise with changes in the system without disruption to staff and patients;
- develop a decision support system to establish the benefit of operational changes and/or as a planning tool;
- analyse a rise in population requiring treatment through the ED and opening of alternative treatment facilities such as hospitals, after hours clinics and mental health facilities;
- analyse the effects of major crises such big accidents, disasters, terrorist attacks, etc. on the system; and

- investigate impact on the system of bed numbers changing, physician shifts, other staffing and facility changes.

In the model all arrivals join a single queue in the waiting room. Both ambulance arrivals and walk-ins join this single queue. This queue is a priority-FIFO queue with patients being seen in order of priority (Category 1 through to Category 5) with the patients within a category group being seen in order of arrival. Lower category patients are bumped down the queue every time a higher priority patient enters the ED. When both a bed and a doctor are available the patient at the top of the queue enters an ED bed. The patient remains in the bed for the treatment time and, if the patient is to be admitted, the post discharge decision time. All patients are then discharged home; to an inpatient bed; to the morgue; the observation ward; or transferred to an alternative hospital. Patient flow through the Emergency Department is given in Figure 1.

The simulation model was run for a period of 90

days and results averaged from 100 runs. Due to the system starting in an empty state the model had warm up periods that ranged between 7-14 days, but the system predominantly was in a steady state within 8-10 days.

A simplistic Extend model shows the basic path through the ED in the model in Figure 2. Patients were generated and combined into a single stream as they are triaged and enter the waiting room queue. The bed that the patient can enter is dependent on their category and patients wait in the resource queue until a doctor is available to take them to the bed and perform an initial consultation. If all beds are full Category 2 patients were routed to the corridor positions, otherwise they enter beds as normal. Once treatment was completed, the patients were discharged and doctors are released into the resource pool, available to see the next waiting patient.

#### 4. MODEL CHARACTERISTICS

The data and information required to formulate an

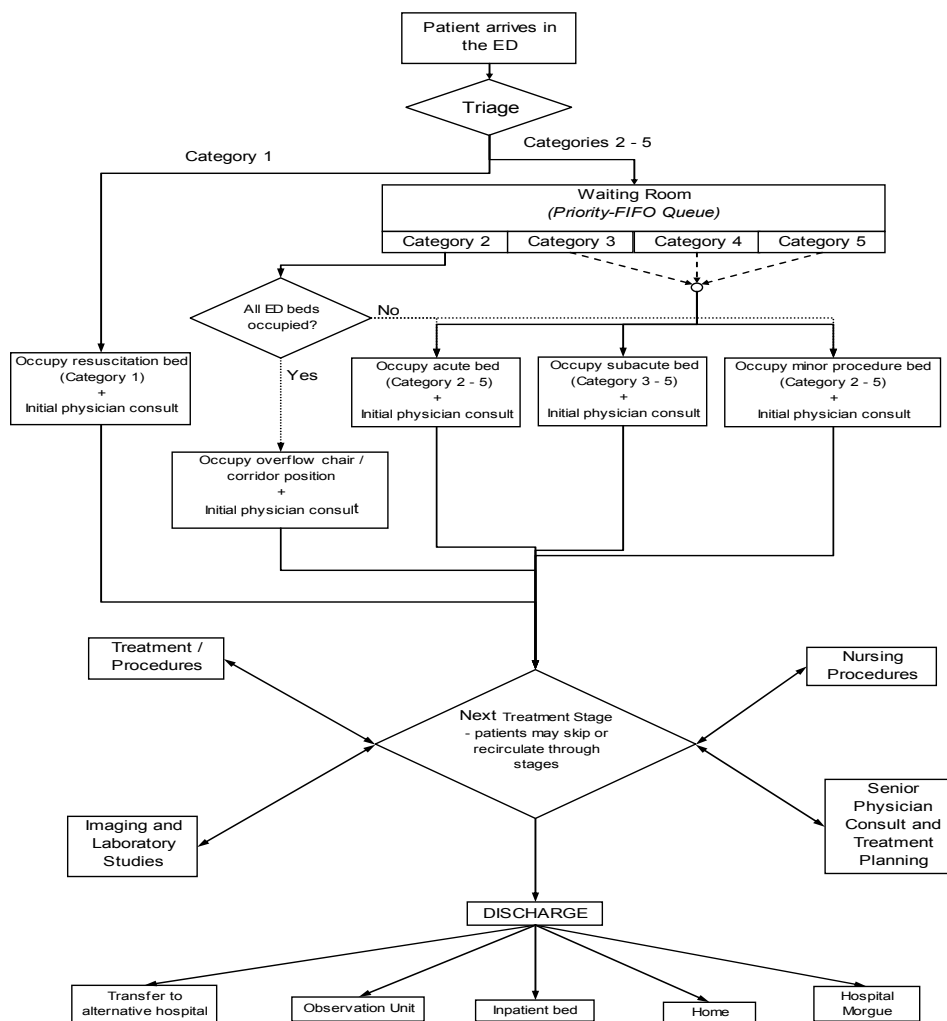

Figure 1. Patient flow through the ED.

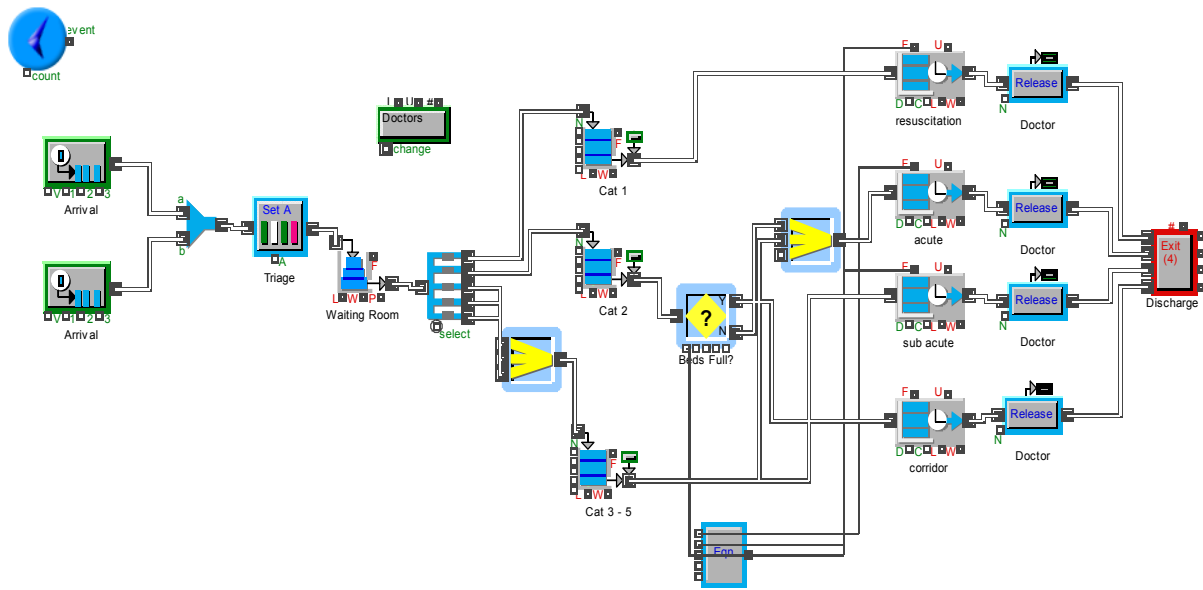

Figure 2. Patient flow through the ED by Extend.

effective model and details are given in this section.

### 4.1 Arrivals

The source of arrivals is considered to be unlimited. The number of patients to be actually treated at any one time is finite but the queue for treatment is infinite. There are effectively no limits to the patient arrivals with the only control being able to sometimes divert ambulances to alternative hospitals. Patients can be of either sex, of any age, and have any disease. These diseases can also be undiagnosed or in an acute phase of its natural course. The arrival, diagnosis and treatment of patients is unscheduled and there is not an option to not treat an arriving patient.

The interarrival times of patients presenting to the Emergency Department needs to be assessed. Patient arrivals are broken down into conditions and a distribution is determined for each of the following condition's interarrival times based on data: Multitrauma; Blood/Immune; Cardiac/Vascular; Diabetes/Endocrine; DNW Prior to Triage; Drug/Alcohol/Poisoning; ENT/Oral; Environmental/Temperature/MISC; Gastrointestinal; GP referred /Hosp transfer; Injury; Neurological; Eye; Nonemergent Review; Obstetrics/Gynaecology; Paediatric; Pain; Psychiatric/Behavioural; Regional Problems; Renal; Respiratory; and Urinary/Reproductive. The interarrival times necessitate study in order to determine the distribution accurately to optimize the model.

Arrivals are generated by their condition according to the distribution that best describes the data and are assigned a triage category. The arrivals are then assigned a treatment time and given inpatient admission status dependent on the triage category. The final assignment is the

post discharge decision time (PDDT), which is assigned from the single distribution that represents PDDT, only if the patient has a positive admission status. Each of the conditions has its own generator block to generate arrivals in the model based on the specific interarrival distribution.

As an example, a Category 4 patient with a gastrointestinal condition is generated in this paper. Gastrointestinal patients arrive with interarrival times according to a Weibull distribution with scale and shape parameters 180 and 0.914 respectively; this being the best fitting distribution. The Weibull distribution density function for gastrointestinal arrivals is given below:

$$f(x) = \frac{\alpha}{\beta} \left(\frac{x}{\beta}\right)^{\alpha-1} e^{-\left(\frac{x}{\beta}\right)^\alpha} = \frac{0.914}{180} \left(\frac{x}{180}\right)^{-0.086} e^{-\left(\frac{x}{180}\right)^{0.914}}$$

The percentages of each category for each condition are determined from the data and used to assign triage

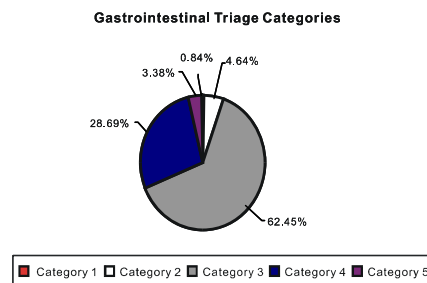

Figure 3. Gastrointestinal triage categories.

categories to the arrivals in the simulation model. Gastro-intestinal patients have the following breakdown of categories that is used to determine the triage category as shown in Figure 3. The minimum correlation between the historical and the simulated data for 4 random runs of 1 month was 0.994.

#### 4.2 Processing Times

The times waiting for each stage in the Emergency Department are also critical to creating a good model. Just as necessary is the time the patient spends in each stage of treatment. The patients, once being admitted to a treatment room, are then placed in other sub-queues as determined by their presenting condition. These sub-queues include staffing resources and diagnostic testing including phlebotomy and imaging.

Once the triage category has been assigned the treatment time and admission status is determined based on the category. The treatment times for Category 4 patients were analysed and the best fit was obtained by a Pearson VI distribution with scale and two shape parameters 355, 1.64, and 5.72 with the following density function:

$$f(x) = \frac{\left(\frac{x}{\beta}\right)^{p-1}}{\beta \left[1 + \left(\frac{x}{\beta}\right)^p\right]^{p+q}} = \frac{\left(\frac{x}{355}\right)^{0.64}}{355 \left[1 + \left(\frac{x}{355}\right)^7\right]^{7.36}} B(1.64, 5.72)$$

where B(p, q) is the beta function.

Figure 4 shows the probability density function for the data and the distribution.

If it is determined that the patient requires admission as an inpatient then the post discharge decision time is generated by an exponential distribution with mean 156 with the following density function:

$$f(x) = \frac{1}{\mu} e^{-\frac{x}{\mu}} = \frac{1}{156} e^{-\frac{x}{156}}$$

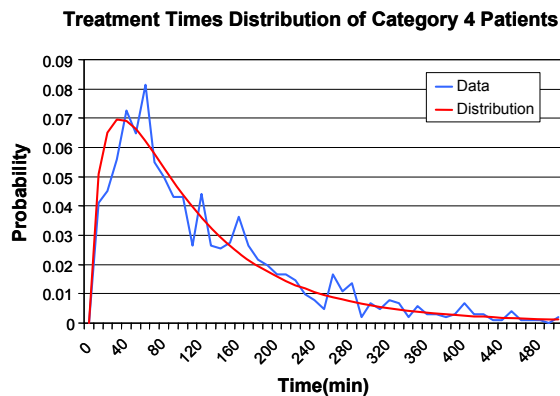

Figure 4. Treatment times distribution of Category 4 patients.

#### 4.3 Priorities

Staffing resources queues are priority based allowing pre-emption, that is, patient treatment may be interrupted for treatment of a higher priority with the intent of returning to complete treatment.

#### 4.4 Paths of the Patients

Data is required on the paths that each patient will take through the Emergency Department, which can be evaluated from chart reviews. One study used the chart reviews and billing records to create patient-care-directed algorithms that defined the path that a patient would follow with specific presenting symptoms. Patients in the model follow paths through the ED as shown in Figures 1 and 2. As can be seen paths are highly dependant on triage category.

#### 4.5 Patterns of the Arriving Patients

Due to the possibility of the patient presenting with any condition or disease and being in any stage of that disease, patients have a variable time in the system. There are guidelines that advise of, and physicians' experiences would dictate as to the expected length of time required for treatment of any presenting conditions. There is no prior knowledge of the arrivals that will be requiring treatment in the Emergency Department in a given period of time. This creates an online system which complicates the model and adds complexity to applying optimal schedules combined with the stochastic nature of the system. The number of patients attending the Emergency Department has shown cyclical patterns and patterns evolving from other phenomenon. The model determined process times from 12 months of historical data by breaking up the patients into categories based on characteristics including condition, time of day, triage category, admission requirements, and productivity rates of the resources.

#### 4.6 Queuing Characteristics

The assignment of the next arrival to enter the system is determined by a priority rule. Patients are triaged and seen according to need. The Australasian College for Emergency Medicine gives the Australasian Triage Scale and the recommended maximum time between arrival in the Emergency Department queue and the commencement of treatment. The assumption is that if these patients are not seen within this time their condition will degenerate requiring further time in the system when they are finally treated. The triage staff (generally specially trained nurses) give each arrival a category rating and higher categorized patients are seen before lower ranked patients. The categories that patients are sorted into are given in Table 1, along with the recommended and desired times for the patient to be assessed by a physician.

**Table 1.** Australasian triage scale guidelines.

Category	Response	Description
1	Immediately	Immediately life threatening
2	10 minutes	Imminently life threatening
3	30 minutes	Potentially life threatening
4	60 minutes	Potentially serious
5	120 minutes	Less urgent

#### 4.7 Reneging

Patients may renege at any stage: prior to triage (balking); while waiting for initial consult; and at any time during stay in an ED bed either waiting for treatment, diagnostic results, or resources. Patients may also leave during treatment. Within the model patients may also balk at any of these stages and patients who left before treatment or during treatment exited the system based on the historical data. Once patients exit the system the resources are then free to treat waiting patients. Patients who leave the ED and return are treated as new arrivals and must wait in the queue as such. Future studies will include more detailed analysis of balking as from observation it has been noticed that patients do not often inform staff of their intention to leave and time of departure is not as accurate for these patients as other patients and therefore resources are not used as efficiently as possible.

#### 4.8 Resources

The resources modelled are both physicians and beds. Patients could only enter the ED system from the waiting room if both resources were available. Physicians are modelled as resources that represented multitasking and simultaneous patient treatment. Physicians in the ED include interns, junior residents, senior residents, registrars and consultants. The registrars and consultants supervise junior staff, consult patients as required and initiate and oversee the treatment of Category 1 and 2 patients. Interns are first year doctors who are able to treat Category 3-5 patients under supervision. Generally, interns can see 1-2 patients simultaneously. Junior and senior residents can treat Category 3-5 patients with supervision as required and form part of the team treating Category 1 and 2 patients. Junior and senior residents can see 2-3 and 2-4 patients simultaneously respectively. The ED has 24 standard treatment areas ranging in equipment available for use. There are an additional 13 corridor positions for stretchers and 3 recliner chairs to be used as overflow treatment areas in cases of critical overcrowding. The ED consisted of resuscitation beds (Category 1 only); acute beds (Category 2-5); subacute beds (Category 3-5); minor procedure rooms (Category 2-5). Future works will include allocating additional resources including nursing staff and diagnostic resources.

#### 4.9 Assumptions

Assumptions in the model included:

- patients who did not wait for treatment used no resources and these arrivals were generated as a condition without balking assumptions;
- overflow beds and chairs were only used for Category 1 and 2 patients if there were no standard treatment rooms available;
- arrival patterns did not vary according to day of the week or other seasonal or subsidiary variations;
- treatment times were dependent on triage category;
- registrars and consultants were considered always available to initiate treatment on Category 1 and 2 patients and were sufficient to consult patients as required and supervise the junior staff;
- the waiting room queue is a priority-FIFO queue with patients with a more pressing need for treatment being seen before lower ranked categories, but in order of arrival within a category;
- all patients are considered equal in the model for inpatient bed placement-triage categories no longer dominate queue position but rather transfer to an inpatient bed depends on availability in the target ward and length of time waiting for bed;
- time between registration and triage assessment is considered negligible and arrival and triage times are considered to be in equivalent in the model.
- preemption occurs in patient treatment procedures and consultations if the resources are required more urgently-this is not reflected in the model due to insufficient patient paths but reflected in overall treatment time distributions and is left for future study.

### 5. OUTPUTS

The following Extend outputs from the model included:

- utilization of the trainee doctors (Figure 5)
- percentage of patients seen within recommended time (Figure 6);
- utilization of the different bed types (Figure 7);
- number of patients waiting (Figure 8).

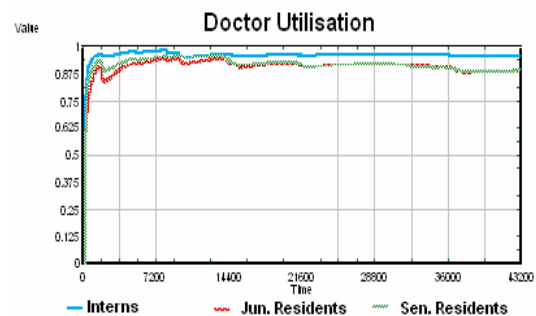
**Figure 5.** Doctor utilisation.



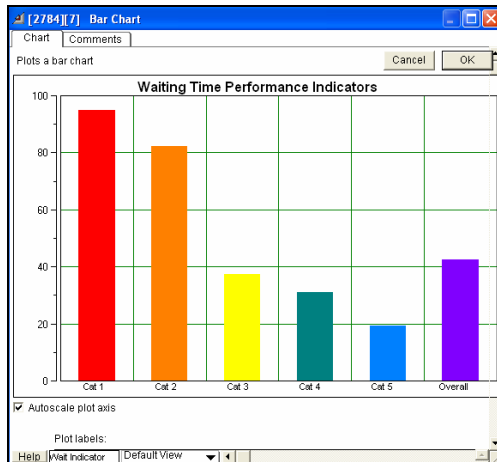

Figure 6. Patients seen within the recommended times.

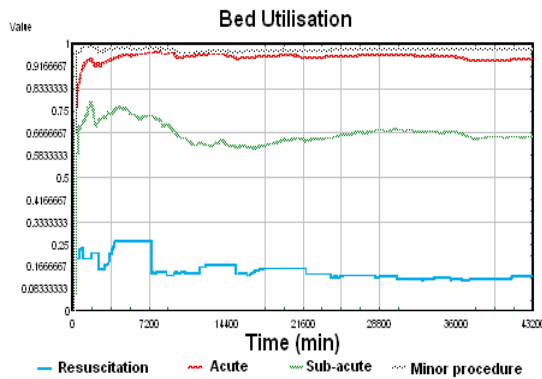

Figure 7. Bed utilisation.

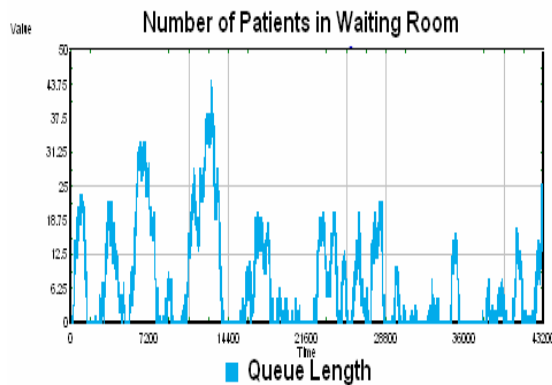

Figure 8. Number of patients in waiting room.

It is found that the variables of average queue length, average waiting time and number of preempted patients are closely related and any one of these could be used to approximate the other. While minimizing these variables the number of patients treated is decreased so the process of balancing the number of patients treated and the number of patients rejected is the main aim of the hospital.

A sensitivity analysis is performed to determine the

effect of changing specific parameters in the system on output variables in the proposed models. The simulation model parameters that were modified in this sensitivity analysis were the arrival rates of patients and the number of beds. Their effect on percentage of patients seen within the recommended time was measured. This analysis is only performed on parameters directly affecting it. The number of beds in the ED is currently 24. In this analysis the number of beds was varied between 17 and 31. The sensitivity analysis of number of beds and number of doctors are varied from -30% to +30% of the current numbers in steps of 5% and the results are summarized in Figure 9.

Taking into account both sensitivity analyses it can be concluded that the system is sensitive to a change in beds and doctors. Furthermore as the data used was only for a short period we can conclude that any increase in accuracy of the input parameters will have effects on the results observed.

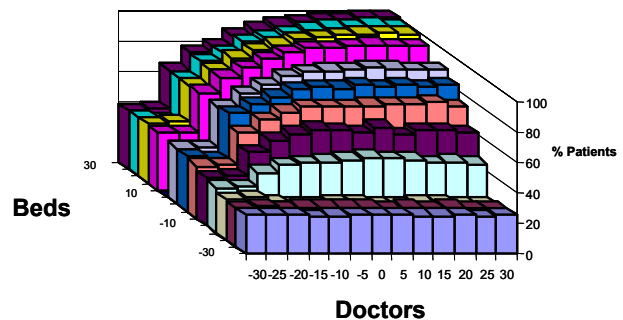

Figure 9. Percentage of patients seen within the recommended times.

Table 2 shows the outputs from the simulation of 100 runs for a period of 90 days for bed utilization, doctor utilization, and overall waiting time performance. As can be seen the model is consistent but has variations due to

Table 2. Mean and Variance of Model Outputs.

	Mean	SD
Resuscitation Bed Utilisation	10.63%	1.15%
Acute Bed Utilisation	95.45%	1.80%
Sub-Acute Bed Utilisation	98.62%	0.70%
Intern Utilisation	98.39%	0.82%
Junior Resident Utilisation	96.87%	1.79%
Senior Resident Utilisation	96.83%	1.85%
Category 1 Waiting Time Performance	94.14%	2.30%
Category 2 Waiting Time Performance	59.14%	3.97%
Category 3 Waiting Time Performance	44.10%	5.43%
Category 4 Waiting Time Performance	22.77%	8.11%
Category 5 Waiting Time Performance	18.40%	8.89%
Overall Waiting Time Performance	39.05%	5.92%



the stochastic nature of the system and the lack of more detailed information of patient paths. Work is continuing in the area of creating a model that will include more finer details of the patient flow and characteristics. Variance is greater in the lower triage categories which is realistic as these patients waiting times are dependent on a number of interacting factors in the ED including arrival patterns, complexity of patient load, resources available, demand of patients on the system, access block, and general flow of the ED.

## 6. CONCLUSIONS

The Princess Alexandra Hospital is used as a case study for the models developed. It is found that statistically significant distributions could be fitted to most of the parameters of the model. Extend is found to be a valuable tool to describe the system because of its flexibility and visual nature. Also useful were its input and output analysis tools. It is expected that a more complex simulation model could be constructed using this software in the future.

Future works will more deeply investigate the performance of patient waiting times, resource utilization, access block and costs in order to determine a multiple criteria weighted objective that combines all potential objectives.

It is also found that varying the number of beds and physicians in the ED has an exponential effect on variables within the system. Varying the arrival rate in the ED also had an exponential effect on variables. This is important in decision making and bed allocation.

A decision support system could use the results gained as its basis. By combining the output variables using user specified weightings, different objectives could be minimised or maximised. This would be helpful to determine arrival rates that indicate a new bed is needed, and the best allocation policy between EDs, etc.

It is difficult to put a monetary value on the effects of patients that were rejected, preempted, and had lengthy delays. The effect of this still needs to be compared in some way to a change in operational procedures or a change in the amount of resources in the system, which have fairly accurate monetary costs associated with them. An investigation into this would aid a decision support system and allow alternatives to be compared quantitatively.

More detailed patient information about the processes in the system would allow a more accurate simulation model. This would also lead to comparison of alternative operational procedures.

## REFERENCES

Australasian College for Emergency Medicine (ACEM) (2000), The Australasian triage scale, [www.acem.org.au](http://www.acem.org.au).

- [www.acem.org.au/open/documents/triage.htm](http://www.acem.org.au/open/documents/triage.htm).
- Australasian College for Emergency Medicine (ACEM) (2001), Standard terminology, [www.acem.org.au/open/documents/standard.pdf](http://www.acem.org.au/open/documents/standard.pdf).
- Australasian College for Emergency Medicine (ACEM), (1998), Emergency department design guidelines, [www.acem.org.au/open/documents/ed design](http://www.acem.org.au/open/documents/ed%20design).
- Alessandra A. J., Grazman T. E., Parameswaran R. and Yavas U. (1978), Using Simulation in Hospital Planning, *Simulation*, **30**(2), 62-67.
- Badri M. A. and Hollingsworth J. (1993), A Simulation Model for Scheduling in the Emergency Room, *International Journal of Operations and Production Management*, **13**, 13-24.
- Bagust, A., Place, M. and Posnett, J. W. (1999), Dynamics of bed use in accommodating emergency admissions: stochastic simulation model, *BMJ*, **319**, 155-158.
- Barnard, A., (2002), Study Ties Crowded Emergency Rooms to Surgeons' Schedules, Boston Globe, Boston.
- Blake J. T., Carter M. W. and Richardson S. (1996), An Analysis of Emergency Wait Times Issues via Computer Simulation, *INFOR* 1996, **34**, 263-273.
- Connelly, L. G. and Bair, A. E. (2004), Discrete event simulation of emergency department activity: A platform for system-level operations research, *Academic Emergency Medicine*, **11**(11), 1177-1185.
- Cote M. J. (1999), Patient Flow and Resource Utilisation in an Outpatient Clinic, *Socio-Economic Planning Sciences*, **33**, 231-245.
- Department of Health and Ageing (2005), The state of our public hospitals, <http://www.health.gov.au/internet/wcms/publishing.nsf/Content/health-ahca-sooph>.
- Estey, A., Ness, K., Saunders, L. D., Alibhai, A. and Bear, R. A. (2003), Understanding the causes of overcrowding in emergency departments in the capital health region in Alberta, *Canadian Journal of Emergency Medicine*, **5**(2).
- Extend\_6, (2002), <http://www.imaginetthatinc.com>.
- Gonzalez-Martinez, M., Borges, J. A., Navarro, J. and Rodriguez, N. J. (1997), An automatic resource scheduling system (ARSS), *Computers and Industrial Engineering*, **33**, 295-298.
- Gove D. and Hewett D. (1995), A Hospital Capacity Planning Model, *OR Insight*, **8**(2), 12-14.
- Hancock W. M., Magerlain D. B, Storer R. H. and Martin J. B. (1978), Parameters Affecting Hospital Occupancy and Implications for Facility Sizing, *Health Services Research*, **13**, 276-289.
- Huang X. M., Taylor C. and Stewart I. (1995), Computer Simulation of A&E Department, *OR Insight*, **8**(2), 18-23.
- Hughes, M., Carson, E., Morgan, C. and Silvester, P. (2005), Evaluating control in a surgical progressive-care system, *Control Engineering Practice*, **13**(9), 1123-1128.

- Kao E. P. C. and Tung G. G. (1981), Bed Allocation on a Public Health Care Delivery System, *Management Science*, **27**, 507-520.
- Knox, D. I. (2004), Australia's emergency departments "at or over maximum capacity", a real emergency, [www.acem.org.au/](http://www.acem.org.au/).
- Kozan, E. and Gillingham, S. (1997), An Application of a Simulation Model to the Maternity Ward System of the Wesley Hospital, *International Congress on Modelling and Simulation*, **4**, 1035-1041, Australia.
- Landro, L. (2001), Emergency rooms hope new technology will ease their trauma, *Wall Street Journal*, **13**, July, B1.
- McClellan S. and Millard P. H. (1995), A Decision Support System for Bed-occupancy Management and Planning Hospitals, *IMA Journal of Mathematics Applied in Medicine and Biology*, **12**, 249-257.
- McHardy S., Kozan E. and Cook D. (2004), Modelling of Intensive Care Units and Operating Theatre in Public Hospitals, *The Fifth Asia-Pacific Industrial Engineering and Management Systems Conference*, 13.3.1-13.3.18, Australia.
- McHardy S., Kozan. E. and Cook. D. (2005), Robust Reactive Scheduling Model as Applied to a Public Hospital ICU, *Proceedings of the 18<sup>th</sup> National Australian Society for Operations Research and 11<sup>th</sup> Australian Optimisation*, 75-81.
- Nozar, R. A. (2003), The impact of EMRs can be felt right at the patient's bedside, *Managed Healthcare Executive*, **13**(9), 48-49.
- NSW Health (2001), Shared responsibility for patient care between hospitals and the community: an effective discharge policy, [www.health.nsw.gov.au/policy/gap/publications/pdf/dischpolicy.pdf](http://www.health.nsw.gov.au/policy/gap/publications/pdf/dischpolicy.pdf)
- Pidd M. (1996), Tools for Thinking: Modelling in Management Science, John Wiley and Sons, West Sussex.
- Sarver, J. H., Cydulka, R. K. and Baker, D. W. (2002), Usual source of care and nonurgent emergency department use, *Academic Emergency Medicine*, **9**(9), 916.
- Schriner, J. A., Talmadge, R., Chuong, R. and Hedges, J. R. (2003), Emergency nursing: Historical, current, and future roles', *Journal of Emergency Nursing*, **29**(5), 431-439.
- Vassilacopoulos G. (1985), A Simulation Model for Bed Allocation to Hospital Inpatient Departments, *Simulation*, Nov, 233-241.
- Wellness Institute (2005), The evolving role of emergency, <http://www.wellnessinstitute.mb.ca/news/articles/evolvingemerg1004.php>.