

JPE 8-2-8

# Harmonic Optimization Techniques in Multi-Level Voltage-Source Inverter with Unequal DC Sources

M. Ghasem Hosseini Aghdam<sup>†</sup>, S. Hamid Fathi<sup>\*</sup> and Gevorg B. Gharehpetian<sup>\*</sup>

<sup>†</sup>Electrical Engineering Department, Amirkabir University of Technology, Tehran, Iran

## ABSTRACT

One of the major problems in electric power quality is the harmonic contents. There are several methods of indicating the quantity of harmonic contents. The most widely used measure is the total harmonic distortion (THD). Various switching techniques have been used in static converters to reduce the output harmonic content. This paper presents and compares the two harmonic optimization techniques, known as optimal minimization of the total harmonic distortion (OMTHD) technique and optimized harmonic stepped-waveform (OHSW) technique used in multi-level inverters with unequal dc sources. Both techniques are very effective and efficient for improving the quality of the inverter output voltage. First, we describe briefly the cascaded H-bridge multi-level inverter structure. Then, we present the switching algorithm for the inverter based on OHSW and OMTHD techniques. Finally, the results obtained for the two techniques are analyzed and compared. The results verify the effectiveness of the both techniques in multi-level voltage-source inverter with non-equal dc sources, clarifying the advantages of each technique.

**Keywords:** Multi-level inverter, OHSW technique, OMTHD technique, Unequal dc sources, Homotopy algorithm

## 1. Introduction

Multi-level inverter is recently used in many industrial applications such as ac power supplies, static VAR compensators, drive systems, etc <sup>[1-10]</sup>. One of the significant advantages of multi-level structure is the harmonic reduction in the output waveform without increasing switching frequency or decreasing the inverter output power. The output voltage waveform of a multi-level inverter is composed of a number of levels of voltages, typically obtained from capacitor voltage sources.

The so-called multi-level starts from three levels. As the number of levels increases, the output THD approaches zero. The number of achievable voltage levels, however, is limited by voltage unbalance problems, voltage clamping requirement, circuit layout, and packaging constraints. Therefore, an important key in designing an effective and efficient multi-level inverter is to ensure that the total harmonic distortion (THD) in the output voltage waveform is small enough <sup>[3-10]</sup>.

The well-known multi-level inverter topologies are: cascaded H-bridge multi-level inverter, diode-clamped multi-level inverter and flying capacitor multi-level inverter <sup>[4]</sup>.

The multi-level inverter composed of cascaded H-bridges with separate dc sources (SDCSs), hereafter

Manuscript received Nov. 21, 2007; revised Feb. 19, 2008

<sup>†</sup>Corresponding Author: h.aghdam@aut.ac.ir

Tel: +98-21-64543550, Fax: +98-21-66406469, Amirkabir Univ.

<sup>\*</sup>Amirkabir Univ. of Tech., Electrical Eng. Dept., Iran

called a cascaded multi-level inverter, appears to be superior to the other multi-level topologies in terms of its structure that is not only simple and modular but also requires the least number of components. This modular structure makes it easily extensible to higher number of output voltage levels without undue increase in power circuit complexity. In addition, extra clamping diodes or voltage balancing capacitors are not necessary<sup>[4,6]</sup>.

It is generally accepted that the performance of an inverter, with any switching strategy, can be related to the harmonic contents of its output voltage. Power electronics researchers have always studied many novel control techniques to reduce harmonics in such waveforms<sup>[4]</sup>. Up to now, in multi-level technology, several well-known modulation techniques have been used as follows<sup>[4]</sup>: Harmonic Optimization, Space Vector PWM (SV-PWM), and Carrier-Based PWM techniques.

The harmonic optimization techniques can be categorized into two methods: Optimal Minimization of the Total Harmonic Distortion (OMTHD) and Optimized Harmonic Stepped-Waveform (OHSW). OMTHD technique is based on minimization of THD by reducing all harmonics with no emphasis on any particular component, where as, OHSW is based on elimination of some specific harmonic components.

In this paper, OMTHD and OHSW techniques are applied to a cascaded multi-level inverter with non-equal dc sources. Usually, it is assumed that the dc sources are all equal, which will not probably be the case in practice even if the dc sources are nominally equal<sup>[3-4]</sup>. Here the dc sources are taken with different voltages for generality of the study. The study is performed for both cases focusing on harmonic content of the output voltage and the results obtained by the two techniques are compared. The paper is organized as follows: First the cascaded H-bridge multi-level inverter's structure and operation are briefly described. Then, the switching algorithms for the multi-level inverter, based on OHSW and OMTHD techniques are explained. Finally, the results obtained for the two techniques are analyzed and compared. Also, several informative results verify the effectiveness of both techniques in multi-level inverter with non-equal dc sources, clarifying the advantages of each technique.

## 2. Cascaded H-Bridge Multi-Level Inverter Structure

A cascaded multi-level inverter consists of a number of H-bridge (single-phase full-bridge) inverter units. The general function of this multi-level inverter is to synthesize a desired voltage from several separate dc sources (SDCSs), which may be obtained from solar cells, fuel cells, batteries, ultra-capacitors, etc. Fig. 1 shows a single-phase structure of a cascade multi-inverter with five SDCSs. Each dc source is connected to a single-phase full-bridge inverter. Each inverter can generate three different output voltages,  $+V_i$ , 0 and  $-V_i$  according to the states of the four switching devices. The ac output of full-bridge inverters are connected in series such that the synthesized voltage waveform is the sum of all individual inverter outputs. The number of output voltage levels in a cascaded multi-level inverter is then  $2S+1$ , where  $S$  is the number of dc sources. An example phase voltage waveform for an eleven-level cascaded multi-level inverter with five SDCSs ( $S=5$ ) and five full bridges is shown in Fig. 2. The output voltage is given by  $v_{an}=v_1+v_2+v_3+v_4+v_5$ . With a large of levels and an appropriate switching algorithm, the multi-level inverter results in an output voltage that is almost sinusoidal.

From the voltage waveform in Fig. 2, the voltage of the first step equals to  $V_1$ ; that of the second step equals to  $V_2$  and so on. These voltage levels are supplied by dc sources, whose amplitudes may be different. Considering the waveform in Fig. 2, there are three possible optimization methods to reduce the voltage THD: 1) step heights are optimized with equally spaced steps; 2) step spaces are optimized with the steps of equal height; and 3) optimizing both height and space of the steps. This paper will focus on method 2, with fixed, but not equal, step heights (dc source voltages) and optimizes the switching angles. To achieve these optimized angles, numerical calculation is employed as will be presented later.

## 3. Improving the Output Voltage

As indicated in Fig. 2, the output voltage is a stepped waveform in which  $\theta_1, \theta_2, \dots, \theta_s$  are switching angles and should be determined in order that some specific

harmonics are eliminated or THD is minimized. The Fourier series expansion of the output voltage with unequal dc sources is:

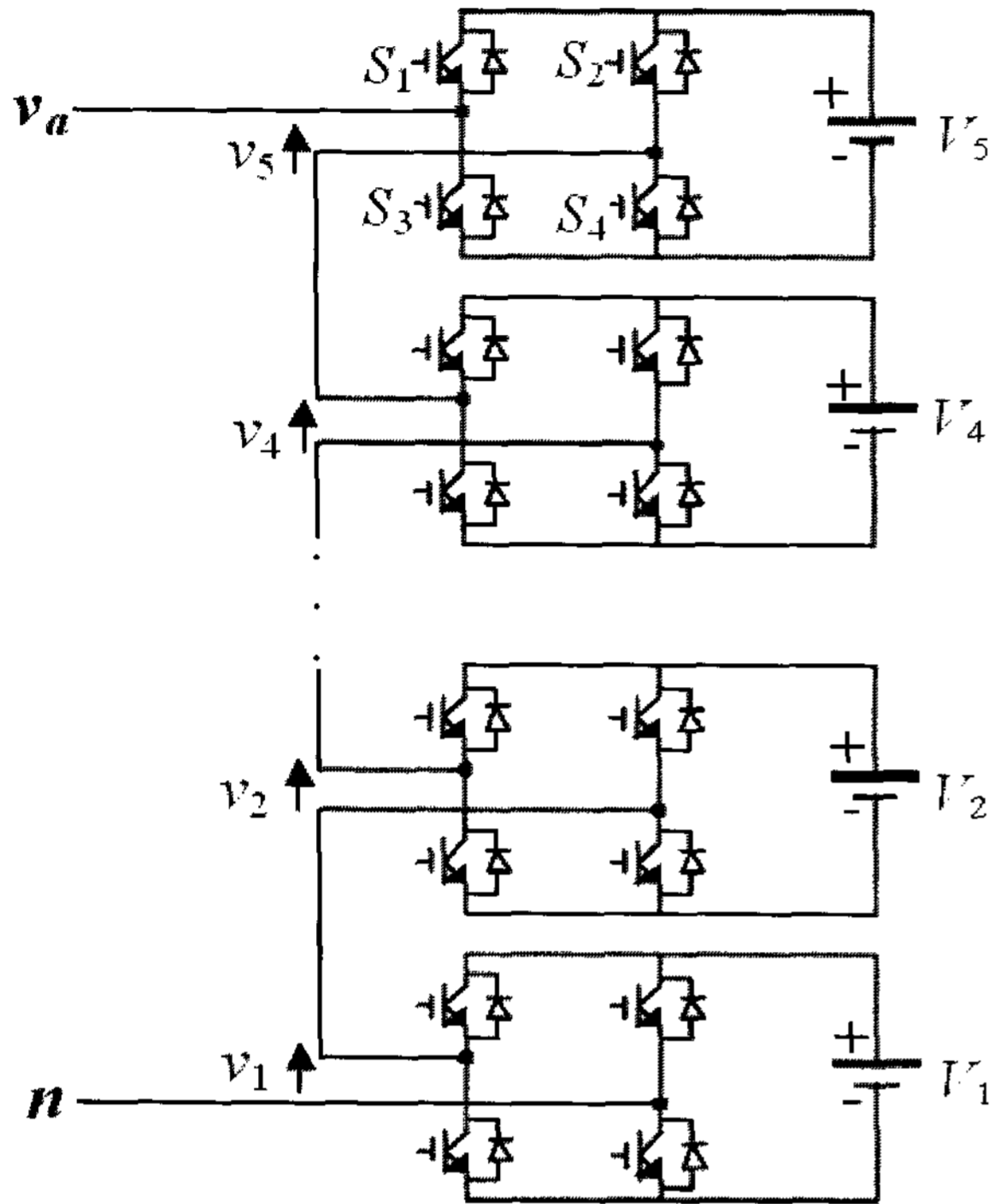

Fig. 1 Single-phase structure of a cascaded H-Bridge multi-level inverter with unequal dc sources

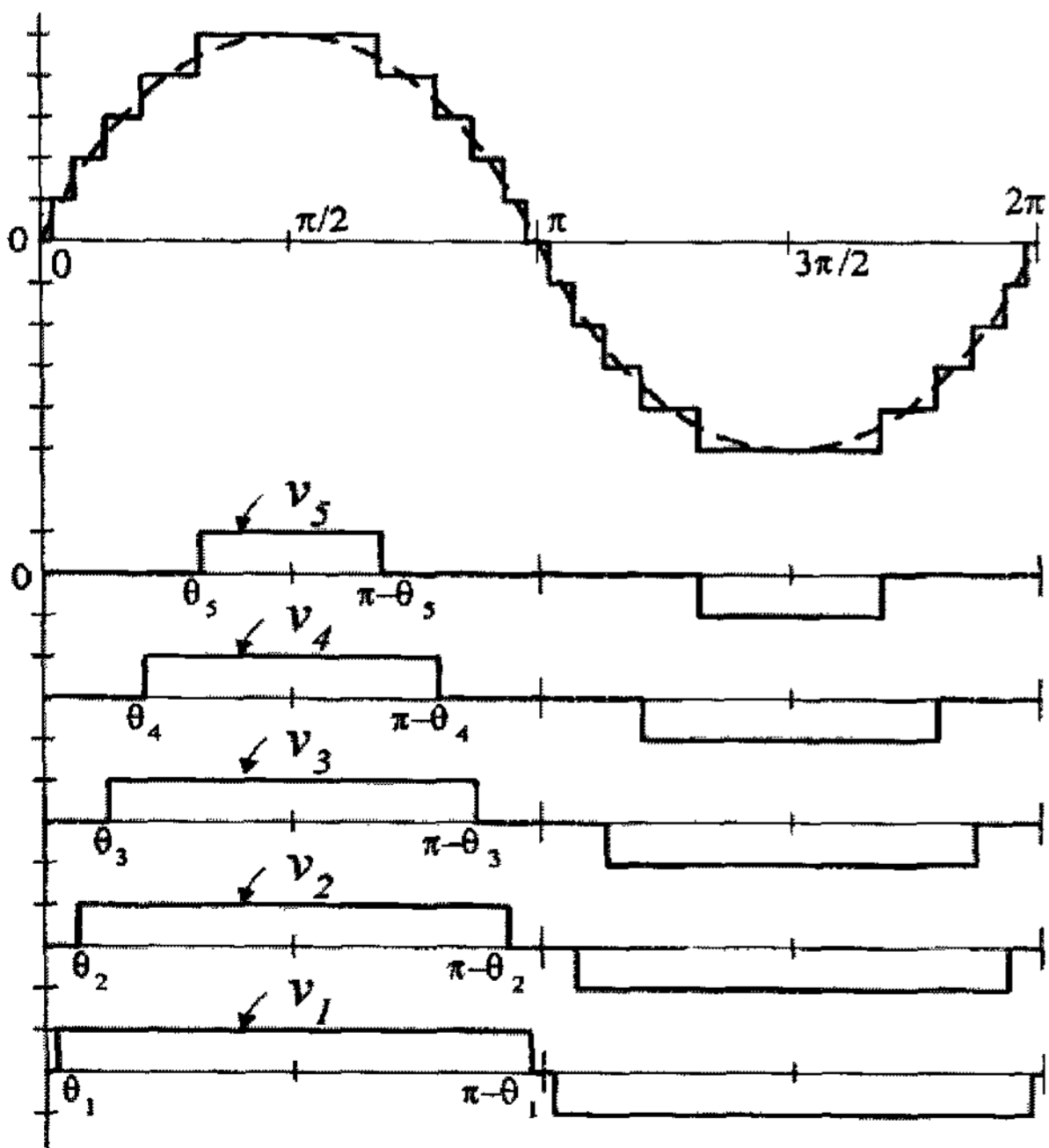

Fig. 2 Output voltage waveform of a cascaded eleven-level inverter

$$V_{om}(\omega t) = \sum_{n=1,3,5,\dots}^{\infty} \left[ \frac{4}{n\pi} \sum_{k=1}^S [V_k * \cos(n\theta_k)] \right] \sin(n\omega t) \quad (1)$$

which comprises the fundamental component:

$$V_f(\omega t) = V_f * \sin(\omega t) = \frac{4}{\pi} \left[ \sum_{k=1}^S V_k * \cos(\theta_k) \right] \sin(\omega t) \quad (2)$$

and the harmonic content:

$$V_n(\omega t) = \sum_{n=3,5,\dots}^{\infty} \left[ \frac{4}{n\pi} \sum_{k=1}^S [V_k * \cos(n\theta_k)] \right] \sin(n\omega t) \quad (3)$$

where  $n$  is odd harmonic order and  $V_k$  is the voltage of  $k^{\text{th}}$  dc source.

Once the generalized expression of output voltage and its harmonic content is specified, one can employ some harmonic reduction technique to determine the proper switching angles, which improve quality of the output waveform. The most commonly used harmonic reduction techniques are: 1- The optimized harmonic stepped-waveform (OHSW) technique, in which the switching angles are so selected that eliminate a number of specific (generally the lowest orders) harmonics [4, 6, 7, 8], 2- The optimal minimization of the total harmonic distortion (OMTHD) technique, in which the switching angles are determined so as to minimize the waveform THD. This reduces, generally, most of the harmonics, without completely eliminating a specific [4, 6].

These two techniques are very suitable in multi-level inverters to improve the output quality. By employing these techniques a low THD output waveform is possible without requiring any additional filtering circuit. Switching devices, in addition, turn on and off only once per cycle. This can overcome the switching loss problem, as well as EMI [4]. These two techniques are briefly explained, applied to the inverter and the results are compared in the following sections.

#### 4. Optimized Harmonic Stepped-Waveform (OHSW) Technique

The objective here is to determine the switching angles  $0^\circ < \theta_1 < \theta_2 < \dots < \theta_s < 90^\circ$  so as to eliminate (S-1) certain lower frequency harmonics from the output voltage

waveform while generating the desired fundamental component,  $V_f$ . This necessitates, mathematically, solving  $S$  equations derived from equation (1). The mathematical statement of these conditions is as follows:

$$\begin{aligned} \frac{4}{\pi} [V_1 \cos(\theta_1) + V_2 \cos(\theta_2) + \dots + V_S \cos(\theta_S)] &= V_f \\ [V_1 \cos(3\theta_1) + V_2 \cos(3\theta_2) + \dots + V_S \cos(3\theta_S)] &= 0 \\ [V_1 \cos(5\theta_1) + V_2 \cos(5\theta_2) + \dots + V_S \cos(5\theta_S)] &= 0 \\ &\vdots \\ [V_1 \cos(h\theta_1) + V_2 \cos(h\theta_2) + \dots + V_S \cos(h\theta_S)] &= 0 \end{aligned} \quad (4)$$

in which  $h$  is the highest order of the harmonics to be eliminated. Note that for three-phase, three-wire systems, and the triplen harmonics in each phase need not to be eliminated, as they are automatically cancelled in the line-to-line voltage.

Assuming  $V_{dc} = V_1 + V_2 + \dots + V_S$ ,  $m_a = V_f / (4V_{dc} / \pi)$  and  $V_{1dc} = V_1 / V_{dc}$ ,  $V_{2dc} = V_2 / V_{dc}$ , ...,  $V_{Sdc} = V_S / V_{dc}$ , equations (4) can be rewritten as:

$$\begin{aligned} [V_{1dc} \cos(\theta_1) + V_{2dc} \cos(\theta_2) + \dots + V_{Sdc} \cos(\theta_S)] &= m_a \\ [V_{1dc} \cos(3\theta_1) + V_{2dc} \cos(3\theta_2) + \dots + V_{Sdc} \cos(3\theta_S)] &= 0 \\ [V_{1dc} \cos(5\theta_1) + V_{2dc} \cos(5\theta_2) + \dots + V_{Sdc} \cos(5\theta_S)] &= 0 \\ &\vdots \\ [V_{1dc} \cos(h\theta_1) + V_{2dc} \cos(h\theta_2) + \dots + V_{Sdc} \cos(h\theta_S)] &= 0 \end{aligned} \quad (5)$$

$S$  equations have been set up, from which, the switching angles  $\theta_1, \theta_2, \dots, \theta_S$  can be calculated. These equations are nonlinear as well as transcendental in nature, which suggests a possibility of multiple solutions. Usually, the Newton-Raphson method [6, 8, 9], mathematical Resultant theory [3,7], and Homotopy algorithm [4-5] are used to solve such nonlinear equation systems. In this paper, Homotopy algorithm is used, which solves the transcendental equations with a much simpler formulation.

## 5. Optimal Minimization of Total Harmonic Distortion (OMTHD) Technique

The basic idea for this method, developed in [6] and confirmed by recent work of [7], is to adjust switching angles in order to minimize the output voltage THD. To

minimize the THD, it is necessary for its partial derivative to be zero with respect to each switching angle. This implies that the partial derivative of its square is also zero because the value of THD is always positive.

After development and some mathematical simplifications, the square THD of the chosen multi-level generalized waveform (periodic with odd quarter-wave symmetric characteristic) depicted in Fig. 2 is given by [6]:

$$\text{THD}^2 = \left[ \frac{\pi^2 \left( \sum_{k=1}^S V_k \right)^2 - \frac{2}{\pi} \left[ \theta_1 V_1^2 + \sum_{j=2}^S \theta_j \left( V_j^2 + 2V_j \sum_{i=1}^{j-1} V_i \right) \right]}{8 \left( \sum_{k=1}^S V_k \cos \theta_k \right)^2} \right]^{-1} \quad (6)$$

Differentiating  $\text{THD}^2$  and setting it equal to zero gives the value of switching angles for minimum THD.

$$\begin{aligned} \frac{\partial (\text{THD}^2)}{\partial (\theta_c)} = 0 \Rightarrow & \left[ \left( V_c^2 + 2V_c \sum_{i=1}^{c-1} V_i \right) \cdot \left( \sum_{k=1}^S V_k \cos \theta_k \right) \right] + \\ & \left[ V_c \sin \theta_c \left[ 2 \left( \theta_1 V_1^2 + \sum_{j=2}^S \theta_j \left( V_j^2 + 2V_j \sum_{i=1}^{j-1} V_i \right) \right) \right] - \pi \left( \sum_{k=1}^S V_k \right)^2 \right] = 0 \end{aligned} \quad (7)$$

where  $C=1, 2, \dots, S$ .

In [6], it is assumed that the dc sources were all equal. Also, in [6], there is no control on the fundamental component of the output voltage. This means that OMTHD technique is applied only for THD minimization with no constraint on the value of fundamental component; where as, the primary objective in any method of inverter control is adjustment of the fundamental component to the desired value.

In this paper, OMTHD technique is applied to the cascaded multi-level inverter with unequal dc sources to minimize THD while producing the desired fundamental component at the output. On the other hand, the fundamental component must have the desired value  $V_f$ . This implies that switching angles must also satisfy the



following equation:

$$\left[ V_{1dc} \cos(\theta_1) + V_{2dc} \cos(\theta_2) + \dots + V_{sdc} \cos(\theta_s) \right] = m_a \quad (8)$$

To solve the set of nonlinear transcendental equations (7) and (8) different methods such as the Newton-Raphson method [6-8], mathematical Resultant theory [3], and Homotopy algorithm [4-5] should be used. As previously mentioned, Homotopy algorithm is used in this paper, which solves the transcendental equations with a much simpler formulation.

## 6. Results and Discussion

To analyze the harmonic performance of the two techniques for purpose of comparison, several harmonic measures are possible. The total harmonic distortion (THD) is one of these measures, which evaluates the quantity of harmonic contents in the output waveform and is a popular performance index for power converters.

As an example for simulation, a seven-level inverter is considered, for which,  $S=3$  and the output voltage is controlled by three switching angles  $\theta_1, \theta_2$  and  $\theta_3$ . The principle parameters of this inverter are assumed as follows:

- dc source voltages are set to be  $V_1=63.00V$ ,  $V_2=51.00V$  and  $V_3=60.60V$ .
- The operation frequency is 50Hz.

Fig. 3 shows the switching angles  $\{\theta_1, \theta_2, \theta_3\}$  versus  $m_a$  for OHSW technique. Comparing Fig. 3 with the simulation and experimental results of [3] verifies the simulation results. The phase and line voltage THD of seven-level inverter with OHSW technique as a function of  $m_a$ , are shown in Fig. 4. As it can be seen in this figure, the minimum value of THD of phase voltage is at  $m_a=0.80$ , with a value of 11.61%. Also, the minimum value of THD of line voltage is at  $m_a=0.78$ , with a value of 6.07%.

Fig. 5 shows the switching angles  $\{\theta_1, \theta_2, \theta_3\}$  versus  $m_a$  for OMTHD technique. The phase and line voltage THD of seven-level inverter with OMTHD technique as a function of  $m_a$ , are shown in Fig. 6. It indicates that the minimum value of THD of phase voltage is 0.36% which

occurs at  $m_a=0.80$ . Also, the minimum value of THD of line voltage is 5.47% at  $m_a=0.78$ .

Fig. 7 and Fig. 8 show the THD of phase and line voltage versus  $m_a$  for both techniques.

Simulation results are summarized in Tables 1 and 2 for two specific values of  $m_a$ . In Table 1, the fundamental component, low order harmonics up to the thirteenth and THD of phase voltage waveform are shown for both techniques. Similar information for the line voltage is given in Table 2.

Despite of a very close performance by the two techniques, the results indicate that THD of output voltage is slightly less when OMTHD method is employed. On the other hand, OHSW method has the advantage of completely removing some low order harmonics of the output voltage, which are normally more troublesome and difficult to be filtered.

THD, as it is defined, measures only the amplitude of harmonics, and the frequency (harmonic order) is ignored. To include the impact of harmonic frequency, another index is used, known as weighted total harmonic distortion (WTHD) and defined by (9).

$$WTHD = \frac{1}{V_1} \left[ \sum_{n=2,3,\dots}^{\infty} \left( \frac{V_n}{n} \right)^2 \right]^{\frac{1}{2}} \quad (9)$$

where:

- $V_1$  is the amplitude of fundamental component,
- $n$  is the order of harmonic and
- $V_n$  is the amplitude of  $n^{\text{th}}$  harmonic.

The phase voltage WTHD of seven-level inverter with OHSW and OMTHD techniques as a function of  $m_a$ , are shown in Fig. 9. As it can be seen in this figure, the minimum value of WTHD of phase voltage for both methods is at  $m_a=0.80$ , with a value of 3.052% for OMTHD technique and 4.20% for OHSW technique.

A three-phase seven-level Y-connected cascaded inverter has been analyzed using power MOSFETs as the switching devices to verify the simulation results. This inverter is connected to a three-phase induction motor with the following parameters:

- Rated power: 3 hp
- Rated voltage: 220 V (rms line-to-line)

- Rated speed: 1725 rpm

In this work, the modulation index ( $m_a$ ) is set equal to 0.80. Note that the switching angles for each technique are taken from Fig. 3 and Fig. 5. The resulting voltages of OHSW technique are measured and are shown in Fig. 10(a). Also, the normalized fast Fourier transform (FFT) of the line voltage between phases  $a$  and  $b$  is shown in Fig. 10(b). It is noted that the triplen harmonics, fifth and seventh harmonics are removed as expected. The phase current in the motor produced by the voltages of Fig. 10(a) is shown in Fig. 10(c). Note that the harmonic content of the current is significantly reduced compared to the harmonic content of the voltage because of the filtering effect of the motor inductance. The THD in the current was computed and found to be 4.24%. The phase and line voltages of OMTHD method are shown in Fig. 11(a) and corresponding normalized FFT is plotted in Fig. 11(b). Also, the phase current in the motor produced by the voltages of Fig. 11(a) is shown in Fig. 11(c). The THD in the current was computed and found to be 4.08% which is less than the voltage THD due to filtering by the motor's inductance.

From these results, it can be noticed that:

1. The THD of output voltage waveform with OMTHD technique is expectedly less than that with OHSW technique. But the difference is considerably small, especially at low values of  $m_a$ .
2. A specified number of low order harmonics are completely cancelled in OHSW technique whereas in OMTHD technique there are some residual values of all harmonic including the low orders. This results in smaller size of output filter in OHSW technique, if it required.
3. In both methods, by observing Figs. 4, 6 and 9, the phase voltage THD is relatively high and increases dramatically, compared to the line voltage THD, as modulation index decreases. This is due to the presence of triplen harmonics in the phase voltage. Also, at the same modulation index, line voltage THD is much less than phase voltage THD. At  $m_a = 0.65$ , for example, the THD of seven-level OHSW output phase voltage is 32.78%, whereas the THD of its line voltage is 9.42%.
4. Despite the cancellation of some low order harmonics in OHSW method, WTHD of output voltage in OMTHD technique is less for a wide range of modulation indexes above 0.55. This is due to the higher amplitude of the most of none-eliminated harmonics in OHSW compared to those in OMTHD.

## 7. Conclusion

Optimal minimization of the total harmonic distortion (OMTHD) technique is used to minimize the THD of the output voltage waveform in a multi-level cascaded inverter. Also, the optimized harmonic stepped waveform (OHSW) technique can be used to eliminate a number lower order harmonics in a multi-level cascaded inverter. In this paper, OMTHD and OHSW techniques have been applied to a seven-level cascaded inverter with unequal dc sources with control on the fundamental component of the output voltage. It has been shown that both techniques are suitable for harmonic optimization of the output voltage. When THD is the measure of comparison, OMTHD technique is better and results in a slightly smaller value of THD. But OHSW technique is superior in that it eliminates a number of trouble some low order harmonics, while producing a THD not very larger than that of OMTHD technique.

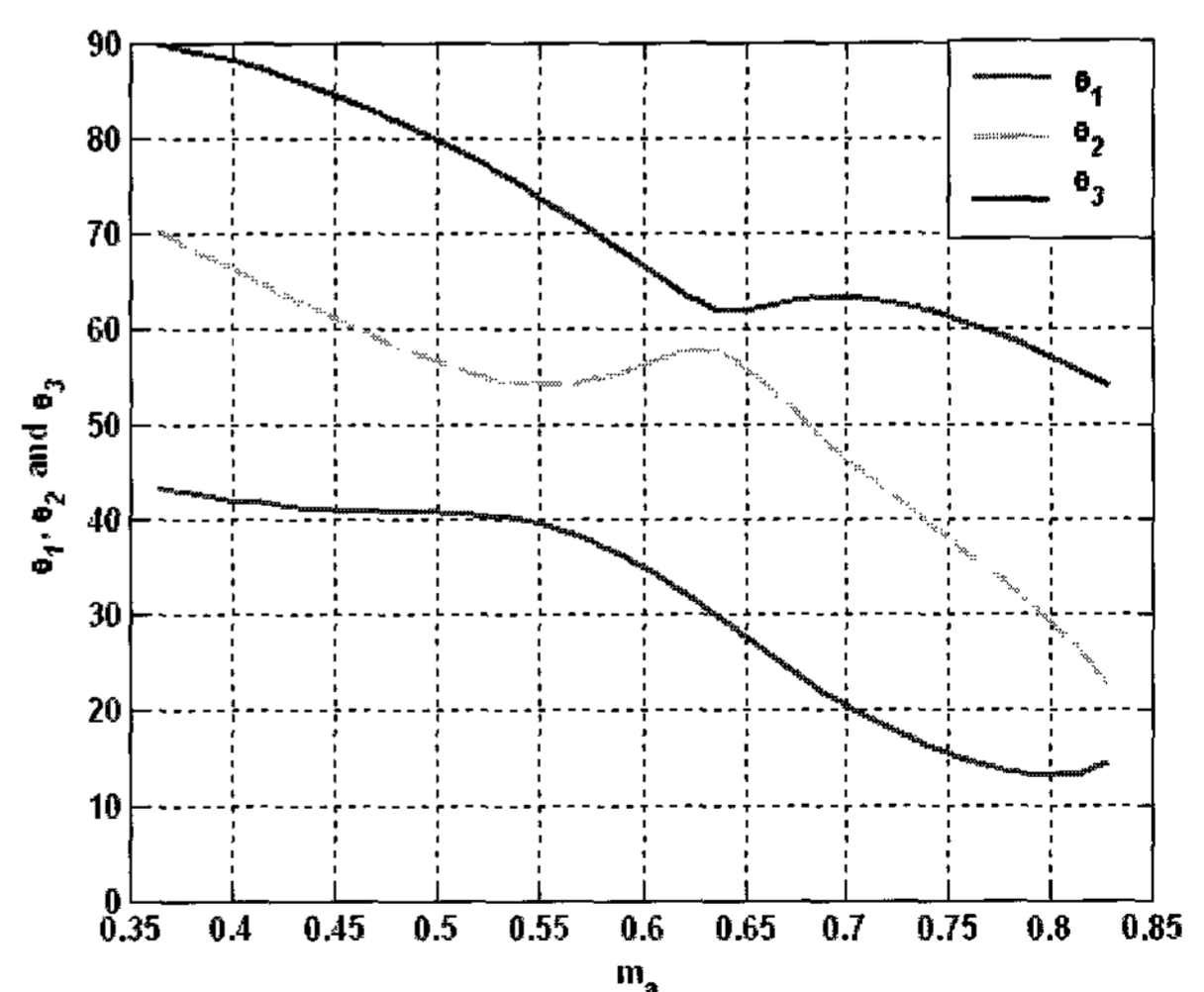

Fig. 3 Switching angles versus  $m_a$  for seven-level inverter (OHSW technique).

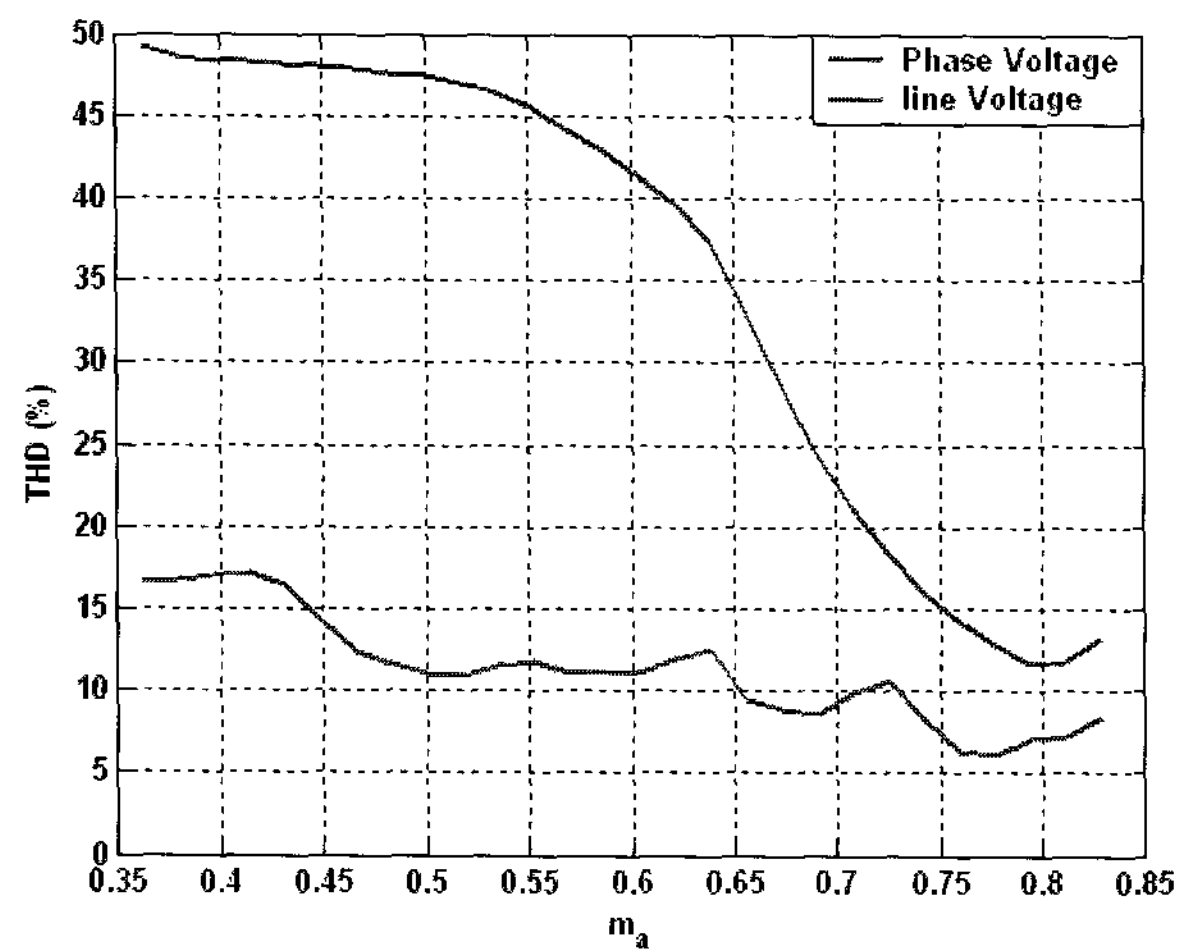

Fig. 4 Phase and line voltage THD as a function of  $m_a$  for seven-level inverter (OHSW technique)

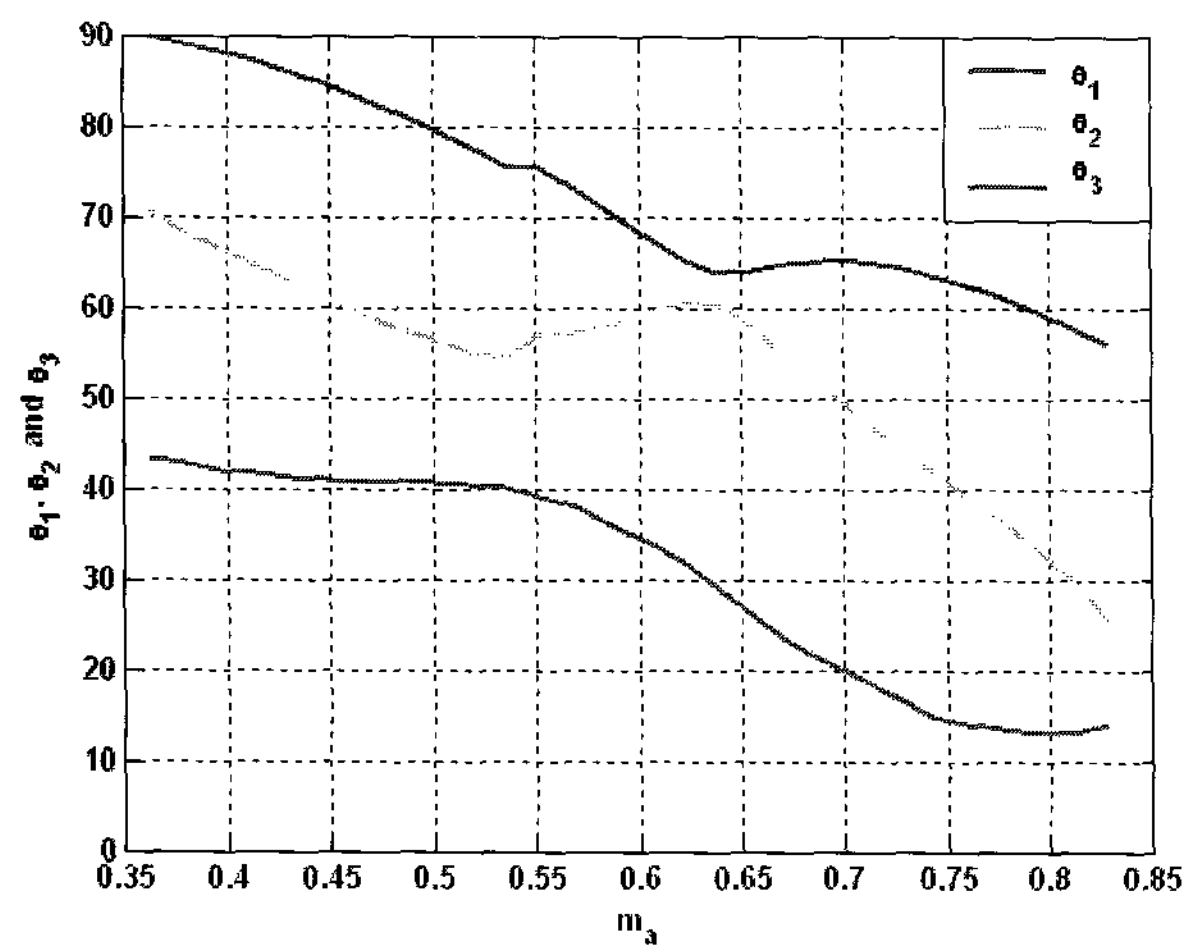

Fig. 5 Switching angles versus  $m_a$  for seven-level inverter (OMTHD technique)

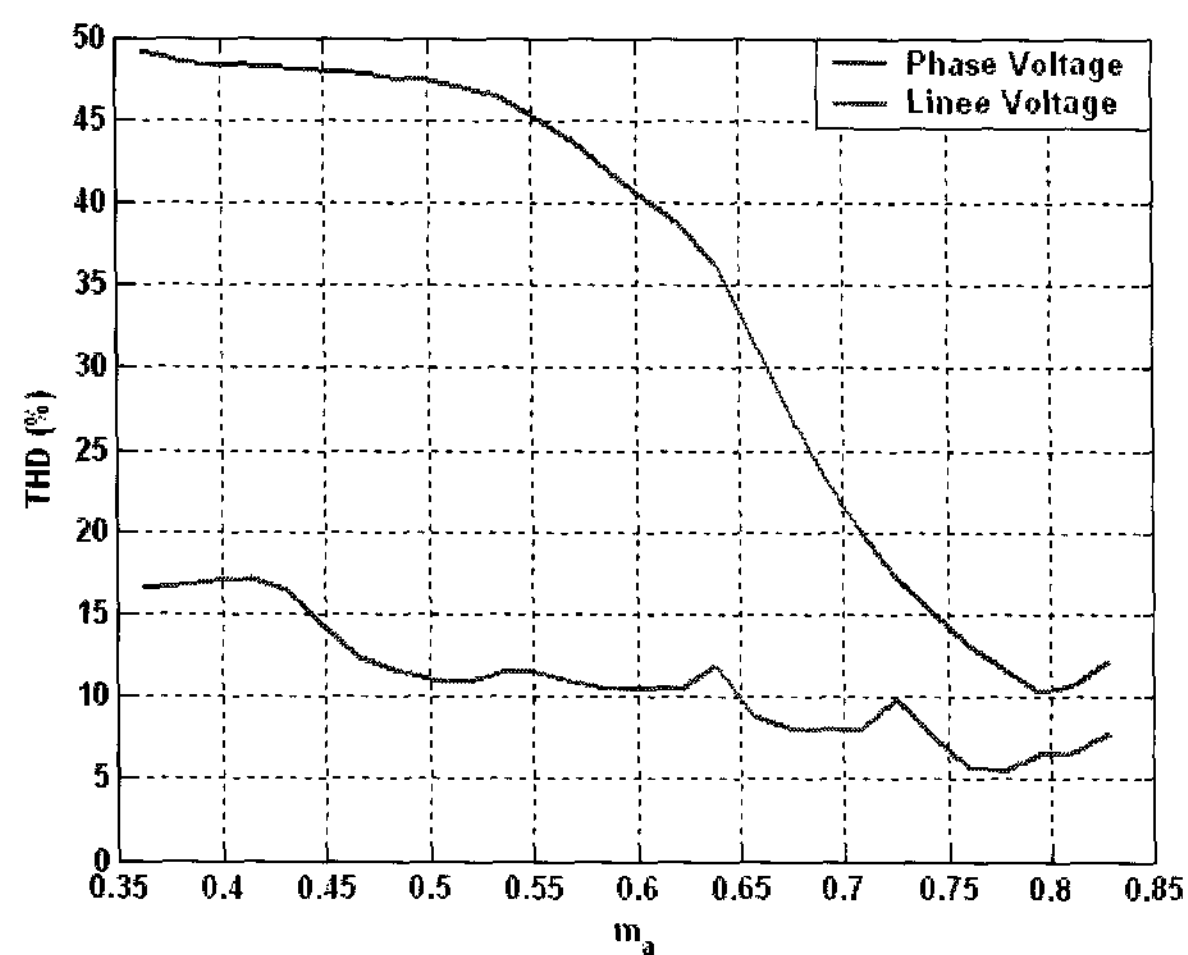

Fig. 6 Phase and line voltage THD as a function of  $m_a$  for seven-level inverter (OMTHD technique)

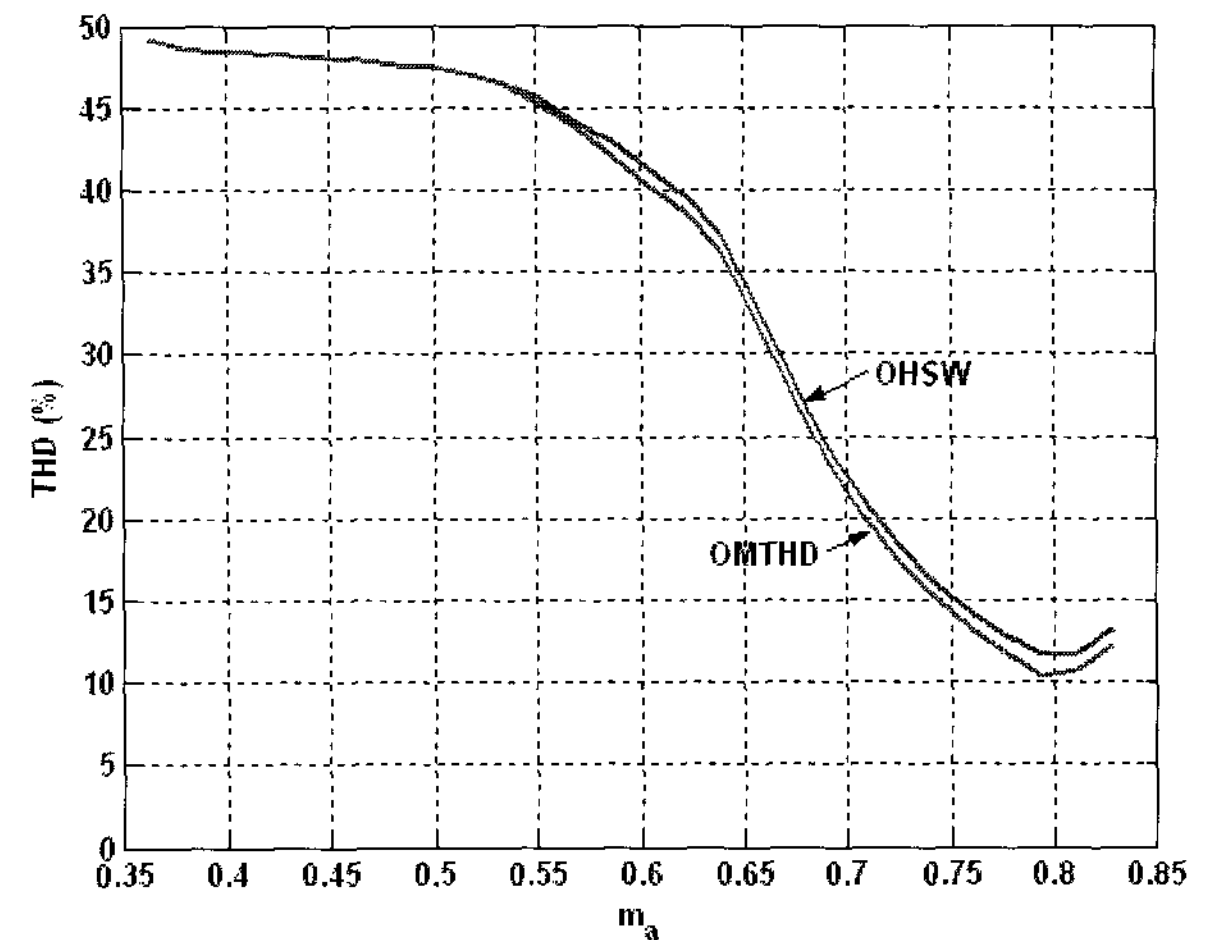

Fig. 7 Phase voltage THD as a function of  $m_a$  for seven-level inverter (OMTHD & OHSW technique)

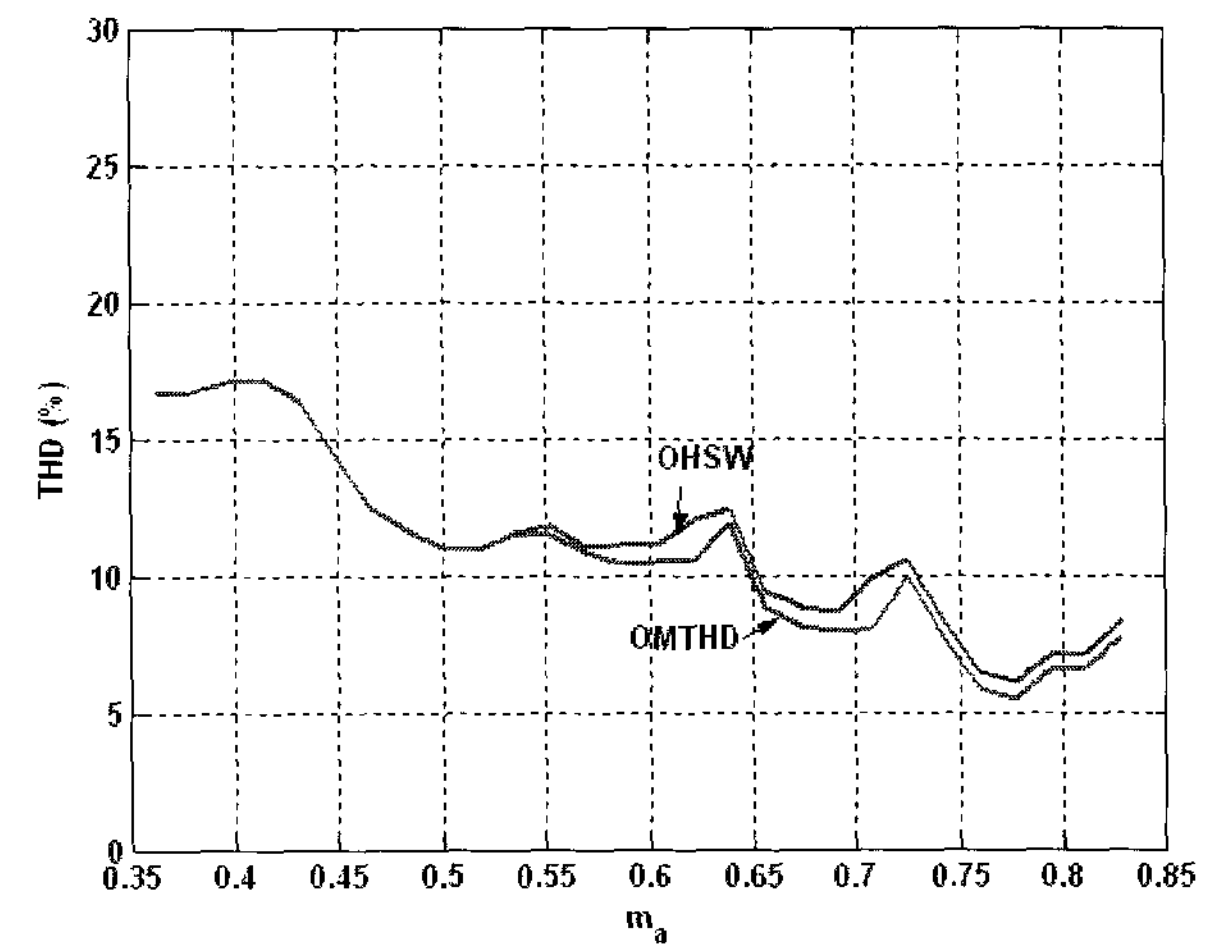

Fig. 8 Line voltage THD as a function of  $m_a$  for seven-level inverter (OMTHD & OHSW technique)

Table 1 Low frequency harmonic components of output phase voltage waveform of seven-level inverter by both techniques

(a)  $m_a=0.65$

Techniques	OMTHD Technique	OHSW Technique
Fundamental (V)	143.9	143.9
3 <sup>rd</sup> (% Fundamental)	28.89	28.88
5 <sup>th</sup> (% Fundamental)	1.99	0.00
7 <sup>th</sup> (% Fundamental)	2.49	0.00
9 <sup>th</sup> (% Fundamental)	5.35	12.15
11 <sup>th</sup> (% Fundamental)	6.17	4.07
13 <sup>th</sup> (% Fundamental)	7.17	7.81
THD %	31.97	32.78

(b)  $m_a=0.80$

Techniques	OMTHD Technique	OHSW Technique
Fundamental (V)	175.00	175.00
3 <sup>rd</sup> (% Fundamental)	4.77	2.79
5 <sup>th</sup> (% Fundamental)	0.38	0.00
7 <sup>th</sup> (% Fundamental)	0.29	0.00
9 <sup>th</sup> (% Fundamental)	5.35	6.65
11 <sup>th</sup> (% Fundamental)	1.36	0.17
13 <sup>th</sup> (% Fundamental)	0.17	1.91
THD %	10.36	11.61

Table 2 Low frequency harmonic components of output line voltage waveform of seven-level inverter by both techniques

(a)  $m_a=0.65$

Techniques	OMTHD Technique	OHSW Technique
Fundamental (V)	250.50	250.50
3 <sup>rd</sup> (% Fundamental)	0.00	0.00
5 <sup>th</sup> (% Fundamental)	0.79	0.00
7 <sup>th</sup> (% Fundamental)	1.29	0.00
9 <sup>th</sup> (% Fundamental)	0.00	0.00
11 <sup>th</sup> (% Fundamental)	4.01	4.02
13 <sup>th</sup> (% Fundamental)	5.78	7.79
15 <sup>th</sup> (% Fundamental)	0.00	0.00
17 <sup>th</sup> (% Fundamental)	0.17	0.42
19 <sup>th</sup> (% Fundamental)	0.71	1.01
THD %	8.82	9.42

(b)  $m_a=0.80$

Techniques	OMTHD Technique	OHSW Technique
Fundamental (V)	303.30	303.30
3 <sup>rd</sup> (% Fundamental)	0.00	0.00
5 <sup>th</sup> (% Fundamental)	0.18	0.00
7 <sup>th</sup> (% Fundamental)	0.13	0.00
9 <sup>th</sup> (% Fundamental)	0.00	0.00
11 <sup>th</sup> (% Fundamental)	0.36	0.17
13 <sup>th</sup> (% Fundamental)	0.07	1.91
15 <sup>th</sup> (% Fundamental)	0.00	0.00
17 <sup>th</sup> (% Fundamental)	2.51	4.50
19 <sup>th</sup> (% Fundamental)	0.24	0.24
THD %	6.50	7.10

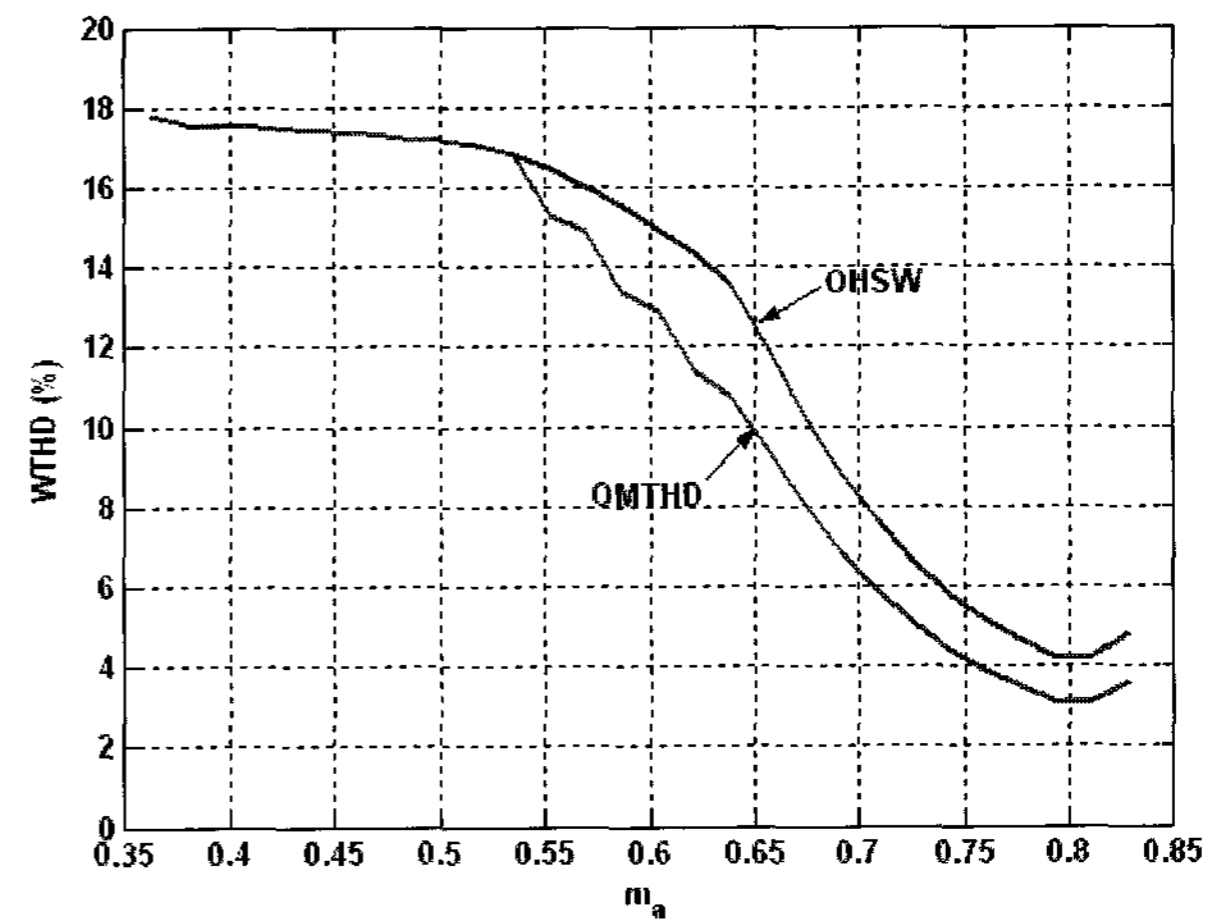
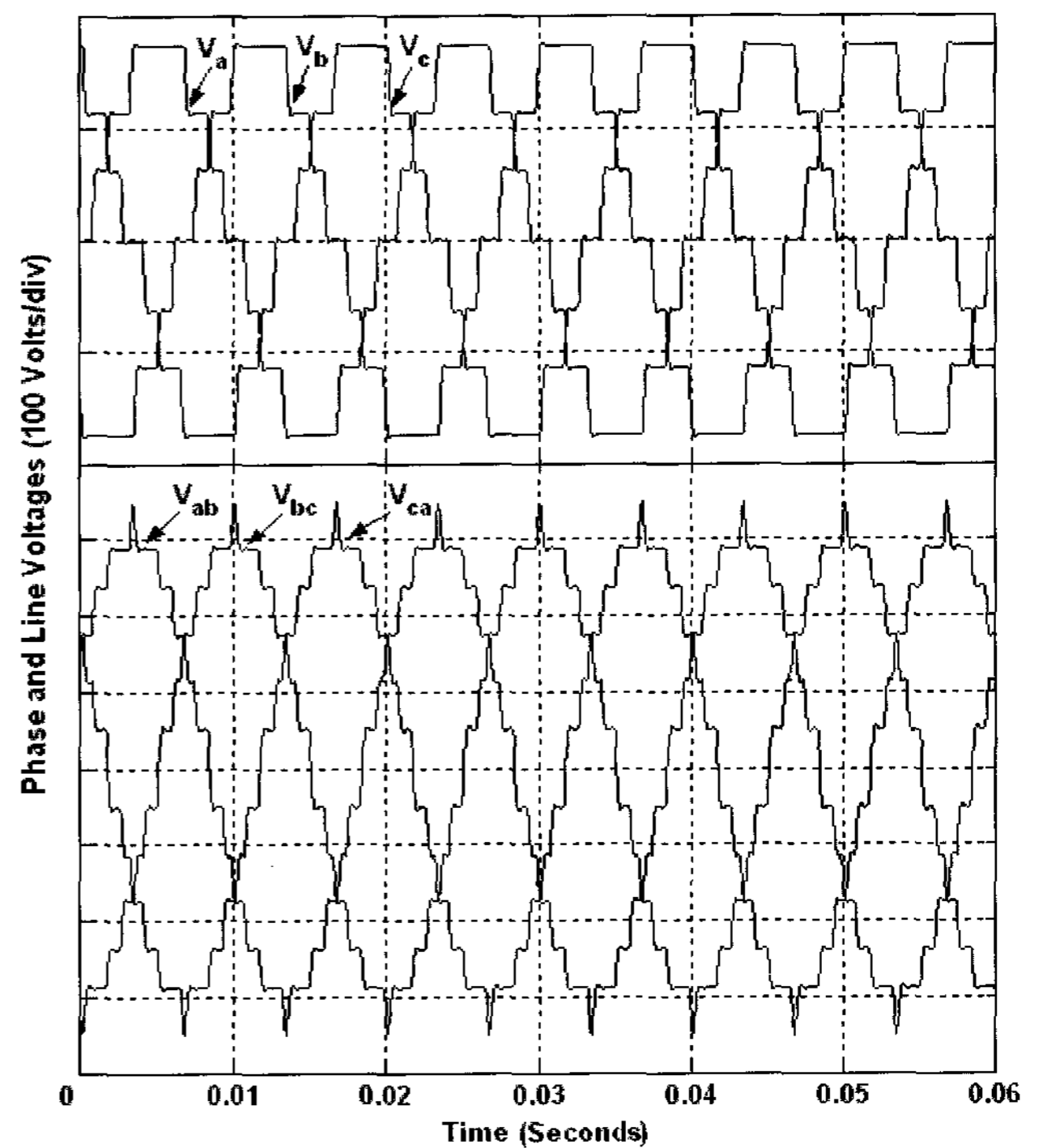
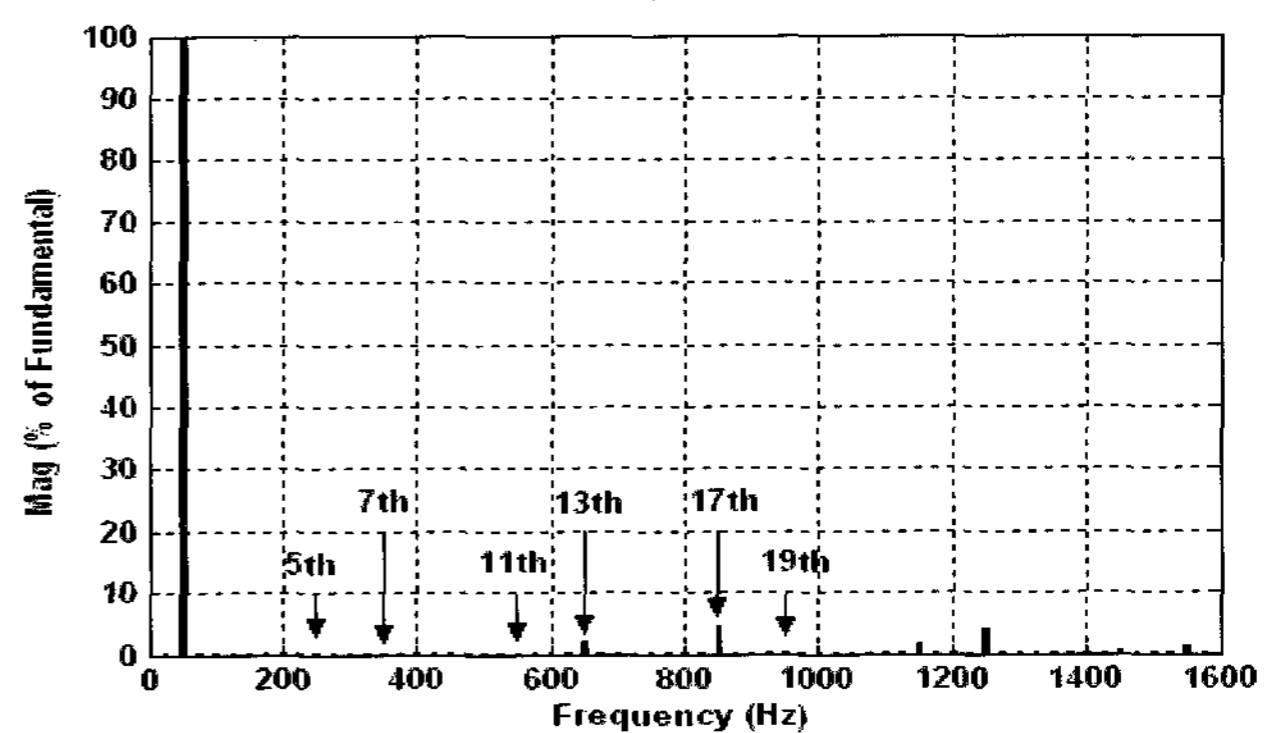

Fig. 9 Phase voltage WTHD as a function of  $m_a$  for seven-level inverter (OMTHD & OHSW technique)



(a)



(b)



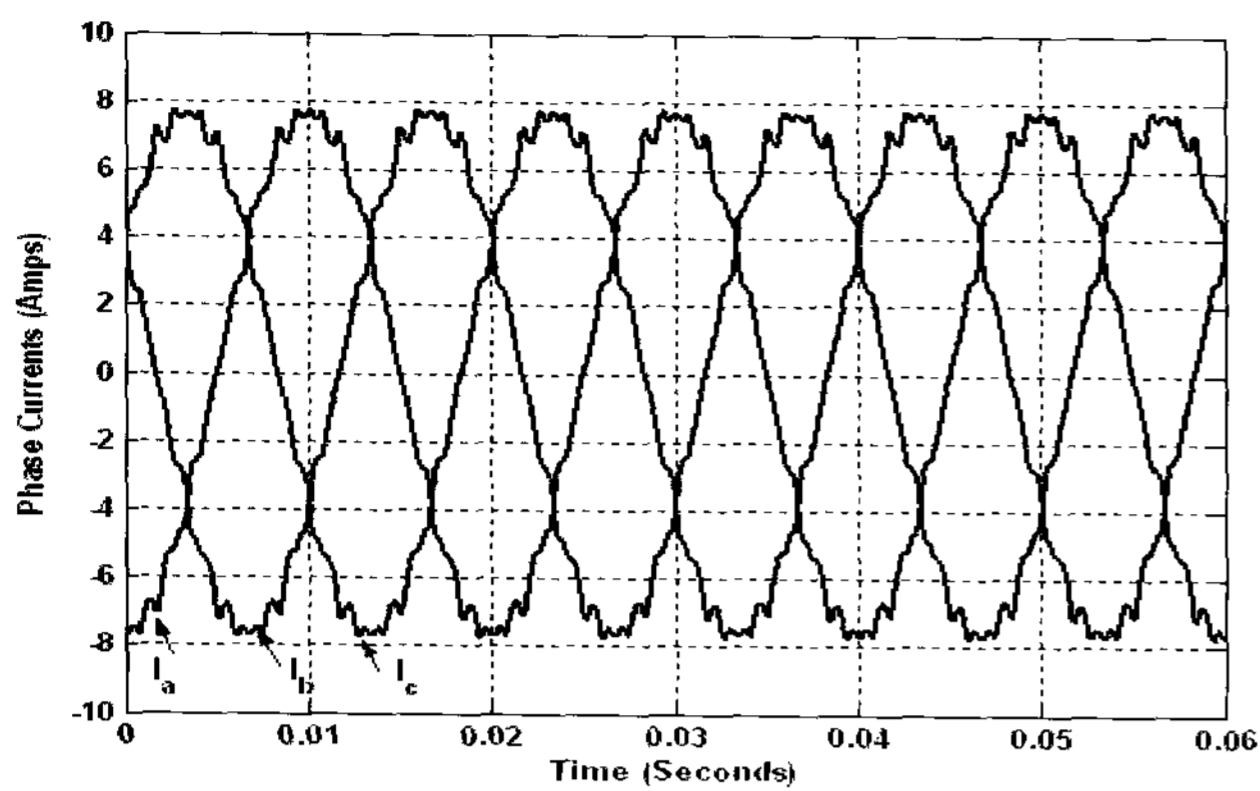

(c)

Fig. 10 OHSW technique (a) Three-phase voltage (phase and line) waveforms for  $m_a=0.80$ , (b) Normalized FFT of the line voltage between phases  $a$  and  $b$ , (c) Current Waveforms

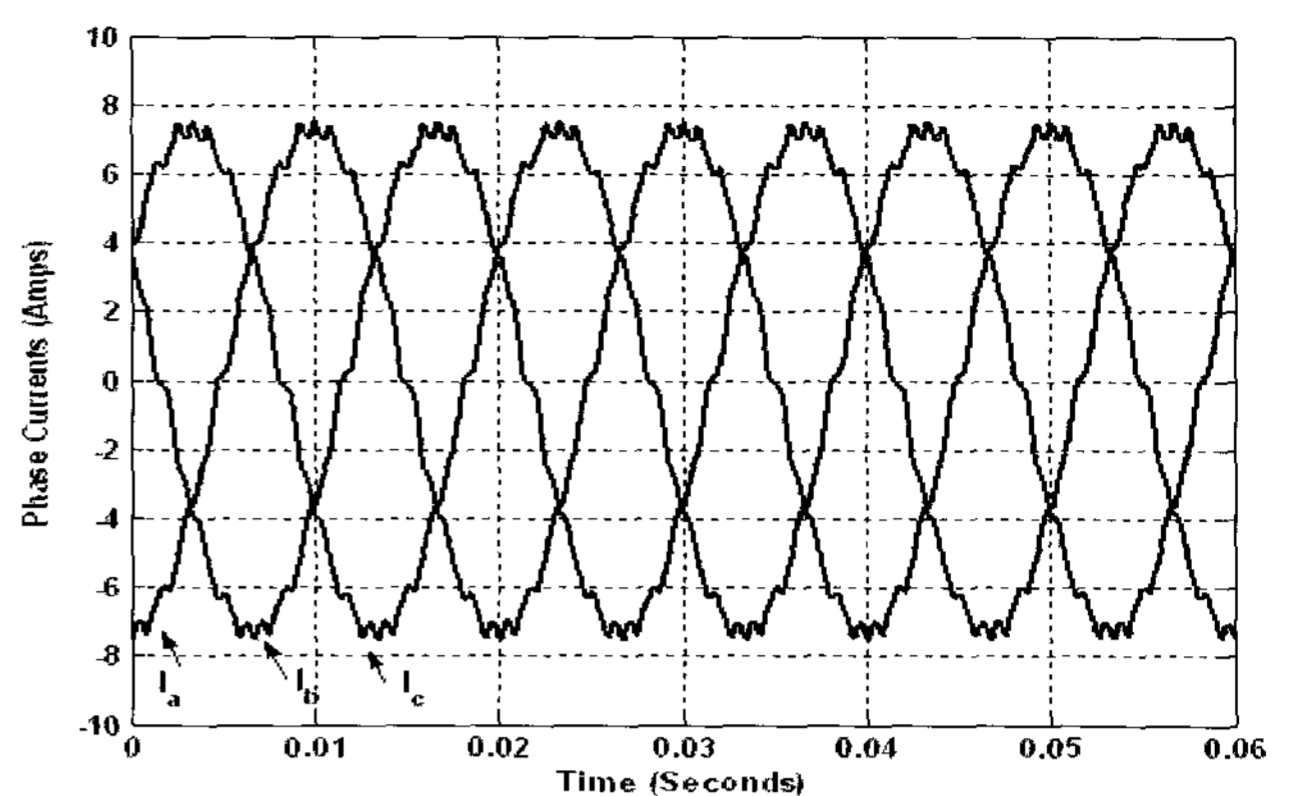

(c)

Fig. 11 OMTHD technique (a) Three-phase voltage (phase and line) waveforms for  $m_a=0.80$ , (b) Normalized FFT of the line voltage between phases  $a$  and  $b$ , (c) Current Waveforms

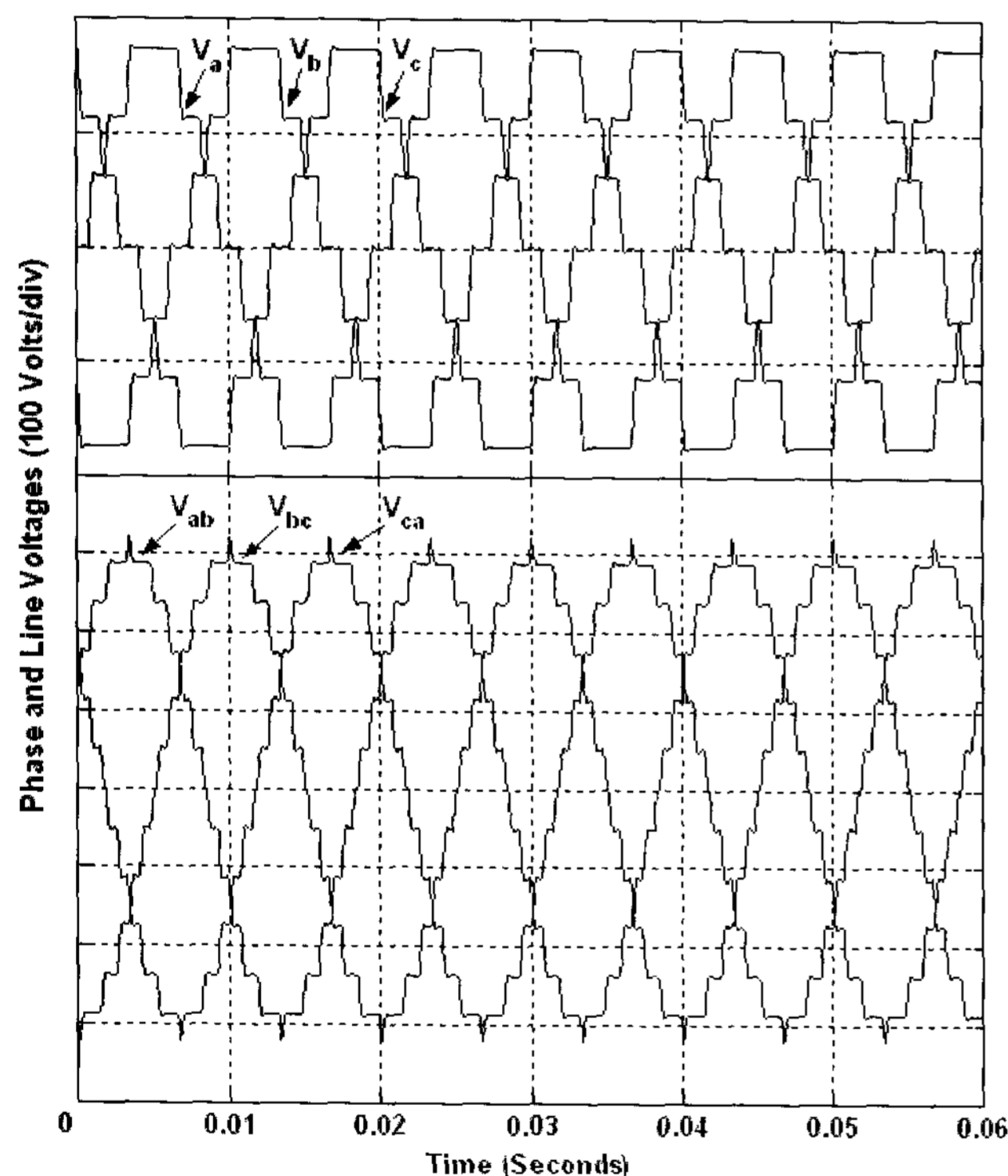

(a)

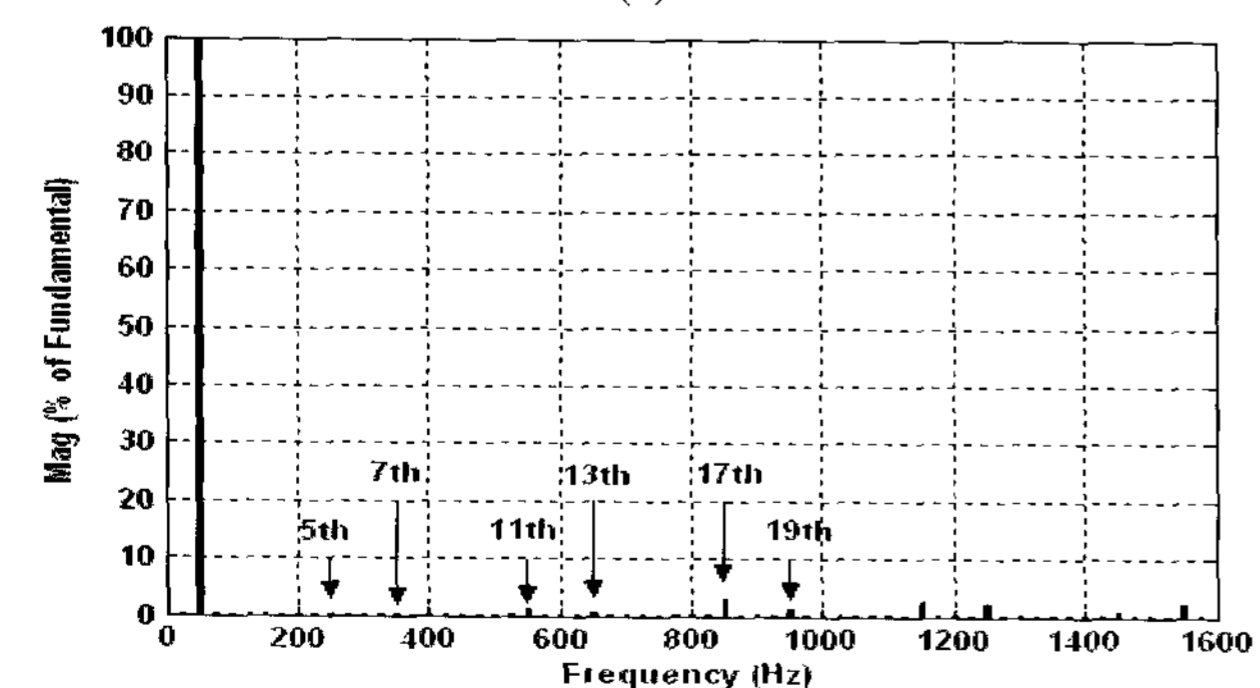

(b)

## References

- [1] F. Peng, "A Generalized Multilevel Inverter Topology with Self Voltage Balancing", IEEE Transactions on Industry Applications, Vol. 37, No. 2, pp. 611-618, March 2001.
- [2] J. Rodriguez, J. S. Lai, and F. Z. Peng, "Multilevel Inverters: A Survey of Topologies, Controls, and Applications", IEEE Transactions on Industrial Electronics, Vol. 49, No. 4, pp. 724-738, August 2007.
- [3] L. M. Tolbert, J. N. Chiasson, Z. Du, and K. J. McKenzie, "Elimination of Harmonics in a Multilevel Converter with Nonequal DC Sources", IEEE Transactions on Industry Applications, Vol. 41, No. 1, pp. 75-81, January/February 2005.
- [4] M. G. Hosseini Aghdam, S. H. Fathi, G. B. Gharehpetian, "Elimination of Harmonics in a Multi-Level Inverter with Unequal DC Sources Using the Homotopy Algorithm", 2007 IEEE International Symposium on Industrial Electronics (IEEE ISIE 2007), Vigo, Spain, pp. 578-583, June 4-7, 2007.
- [5] E. Guan, P. Song, M. Ye, and B. Wu, "Selective Harmonic Elimination Techniques for Multilevel Cascaded H-Bridge Inverters", The 6<sup>th</sup> International Conference on Power Electronics and Drive Systems (IEEE PEDS 2005), Kuala Lumpur, Malaysia, pp. 1441-1446, 28 November- 1 December 2005.
- [6] Y. Sahali, and M. K. Fellah, "Optimal Minimization of the Total Harmonic Distortion (OMTHD) Technique for the Symmetrical Multilevel Inverters Control", First National Conference on Electrical Engineering and its Applications (CNEA'04), Sidi-bel-Abbes, May 24-25, 2004.
- [7] J. N. Chiasson, L. M. Tolbert, K. J. McKenzie, and Z. Dou, "Elimination of Harmonics in a Multilevel Converter Using the Theory of Symmetric Polynomials and Resultants", IEEE

Transactions on Control System Technology, Vol. 13, No. 2, pp. 216-223, March 2005.

- [8] Q. Jiang, and T. A. Lipo, "Switching Angles and DC Link Voltages Optimization for Multilevel Cascade Inverters", Electric Power Components and Systems, Vol. 33, No. 14, October 2005.
- [9] S. Sirisukprasert, J. Lai, and T. Liu, "Optimum Harmonic Reduction with a Wide Range of Modulation Indexes for Multilevel Converters", IEEE Transactions on Industrial Electronics, Vol. 49, No. 4, pp. 875-881, August 2002.
- [10] J. R. Wells, X. Geng, P. L. Chapman, P. T. T. Krein, and B. M. Nee, "Modulation-Based Harmonic Elimination", IEEE Transactions on Power Electronics, Vol. 22, No. 1, pp. 336-340, January 2007.

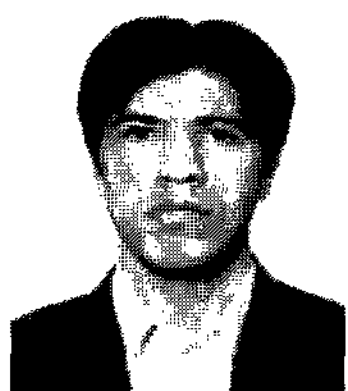

**M. G. Hosseini Aghdam** was born in Shabestar, Iran on September 21, 1978. He received his B.Sc. and M.Sc. degrees in electrical engineering in 2000 and 2003 from Tabriz University, Tabriz, Iran and Amirkabir University of Technology (AUT), Tehran, Iran, respectively. He is currently working toward the Ph.D. degree at Amirkabir University of Technology, Tehran, focusing on control and modulation of multilevel converters. His research interests include modulation theory, multilevel converters, and fundamental principles for power electronic converters.



**S. Hamid Fathi** was born in Abhar, Iran in 1957. He received his B.Sc. and M.Sc. degrees in electrical engineering in 1984 and 1987 from Amirkabir University of Technology (AUT), Tehran, Iran and Iran University of Science and Technology (IUST), Tehran, Iran, respectively. He received the Ph.D. degree in electrical engineering from University of Newcastle upon Tyne, UK, in 1991. The power engineering group of AUT has been selected as a Center of Excellence on Power Systems in Iran since 2001. He is a member of this center His research interests include power quality, flexible ac transmission systems (FACTS), power electronics and electric drives.



**Gevorg B. Gharehpetian** was born in Tehran, Iran in 1962. He received his B.Sc. and M.Sc. degrees in electrical engineering in 1987 and 1989 from Tabriz University, Tabriz, Iran and Amirkabir University of Technology (AUT), Tehran, Iran, respectively, graduating with First Class Honors. In 1989 he

joined the Electrical Engineering Department of AUT as a lecturer. He received the Ph.D. degree in electrical engineering from Tehran University, Tehran, Iran, in 1996. As a Ph.D. student he has received scholarship from DAAD (German Academic Exchange Service) from 1993 to 1996 and he was with High Voltage Institute of RWTH Aachen, Aachen, Germany. He held the position of Assistant Professor in AUT from 1997 to 2003, and has been Associate Professor since 2004. Dr. Gharehpetian is a Senior Member of Iranian Association of Electrical and Electronics Engineers (IAEEE), member of IEEE and member of central board of IAEEE. Since 2004 he is the Editor-in-Chief of the Journal of IAEEE. The power engineering group of AUT has been selected as a Center of Excellence on Power Systems in Iran since 2001. He is a member of this center and since 2004 the Research Deputy of this center. He is the author of more than 200 journal and conference papers. His teaching and research interest include power system and transformers transients, FACTS devices and HVDC transmission.