

# Reduction of the Temporal Bright-Image Sticking in AC-PDP Modules Using the Vacuum Sealing Method

Choon-Sang Park<sup>\*\*</sup>, Byung-Gwon Cho<sup>\*</sup>, and Heung-Sik Tae<sup>\*</sup>

## Abstract

This paper investigates the effects of the existing sealing methods, such as the conventional atmospheric-pressure sealing method and vacuum sealing, on temporal bright-image sticking. To produce a residual image caused by temporal bright-image sticking, the entire region of a 42-in panel with an Xe-(11%)-He(35%) gas mixture was abruptly changed to a full-white background image after displaying a square-type image at peak luminance for about 60s. From the monitoring of the difference in the display luminance, infrared emission, color temperature, and disappearing time between the cells with and without temporal bright-image sticking, it was observed that the vacuum sealing method contributes to the reduction of temporal bright-image sticking.

**Keywords** : AC-PDP, temporal bright-image sticking, vacuum sealing method, IR emission, luminance, color temperature

## 1. Introduction

Despite the suitability of flat-panel devices for digital high-definition televisions, plasma display panels (PDPs) have to address the image-sticking phenomenon, where a residual image appears in the subsequent image when the previous image has been continuously displayed over a few minutes. Although the temporal image-sticking phenomenon in discharge cells is essentially related to the changes in the MgO surface or phosphor layer during a strong sustain discharge, the detailed mechanism of the temporal image-sticking problem has not been fully understood [1-5]. The massive ions during the continuous sustain discharge strikes the MgO surface, thus changing it. The sputtered Mg is accumulated on the phosphor layer, thus reacting with it. Accordingly, the subsequent sustain discharge and visible conversion characteristics are changed. This is the sticking problem. The recovery of the varied sustain discharge and visible conversion characteristics within a short time is what is known as the temporal bright-image sticking phe-

nomenon. The experimental observation that was conducted in this study revealed that the occurrence of temporal bright-image sticking is deeply related to the base vacuum level during the sealing process.

For the conventional 42-in AC-PDP with a box-type barrier rib, the front and rear glasses are typically sealed under atmospheric pressure. The panel is then evacuated using a high-vacuum pump via a glass tip sealed to a corner of the rear glass. The resulting base vacuum level is limited, however, by the pumping conductance of the panel, which in turn is mainly related to the barrier rib shape. Thus, in the case of the conventional 42-in AC-PDP with a box-type barrier rib, the base vacuum level obtained in the center region and in the regions that are distant from the glass tip is only  $10^{-2}$  Torr. Accordingly, to improve the base vacuum level, the vacuum sealing method has been adopted, where the front and rear glasses are sealed under a high-vacuum chamber, resulting in obtaining a base vacuum level of about  $10^{-5}$  Torr for the 42-in panel with a box-type barrier rib [6-14]. Moreover, the gas impurity level also depends strongly on the base vacuum level during the sealing process. In particular, the oxygen impurity level can have a significant effect on the MgO surface state and on the reaction of the phosphor layer to the sputtered Mg. Consequently, the temporal bright-image sticking characteristics of an AC-PDP can be changed according to the base vacuum level during the sealing process [8, 9]. Accordingly, this paper

Manuscript received September 25, 2008; accepted for publication December 2, 2008.

This work was supported in part by Samsung SDI and in part by Brain Korea 21 (BK21).

<sup>\*</sup> Member, KIDS; <sup>\*\*</sup> Student Member, KIDS

Corresponding Author: Heung-Sik Tae

School of Electrical Engineering and Computer Science, Kyungpook National University, 1370 Sankyuk-Dong, Buk-Gu, Deagu 702-701, Korea

E-mail : hstae@ee.knu.ac.kr Tel : 82-53-950-6563 Fax : 82-53-950-5505

investigates the effects of the vacuum sealing method on the reduction of temporal bright-image sticking from a 42-in AC-PDP. The effects of both the vacuum sealing method and the modified driving waveform on temporal bright-image sticking were examined based on the observation of the display luminance, infrared emission, color temperature, and disappearing time.

### 2. Experiment setup

Fig. 1 shows the three electrodes X, Y, and A in the commercial 42-in AC-PDP that was used to monitor temporal bright-image sticking, where the square-shaped pattern (region B) is the discharge region and regions A and C are the non-discharge regions. To produce a residual image caused by image sticking, the entire region of the 42-in panel was abruptly changed to a full-white background image after displaying a square-type image (region B) at peak luminance for a sustain discharge of about 60s. In region B (i.e., the displayed region), the IR emissions during the sustain period were measured before and after the 60s discharge. The cells in region B before the 60s discharge were non-image-sticking cells, whereas the cells in region B after the 60s discharge were image-sticking cells. The luminance and infrared (IR) emission were also measured in regions A, B, and C before and after the 60s discharge, using a luminance analyzer (Chroma meter, CA-100 plus) and a photosensor amplifier (Hamamatsu, C6386). The 42-in test panels were fabricated using two different sealing methods, respectively: the conventional atmospheric-pressure sealing method and the vacuum sealing method. Fig. 2 shows the conventional driving waveform with a selective reset wave-

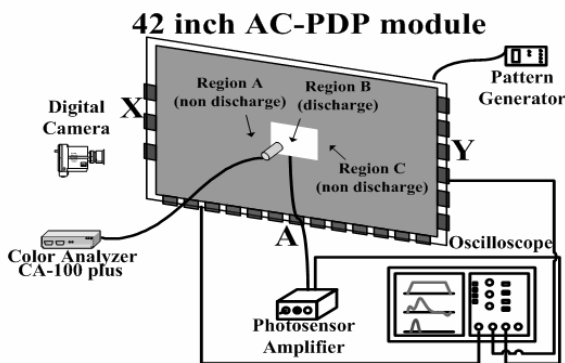

Fig. 1. Schematic diagram of the experiment setup employed in this research.

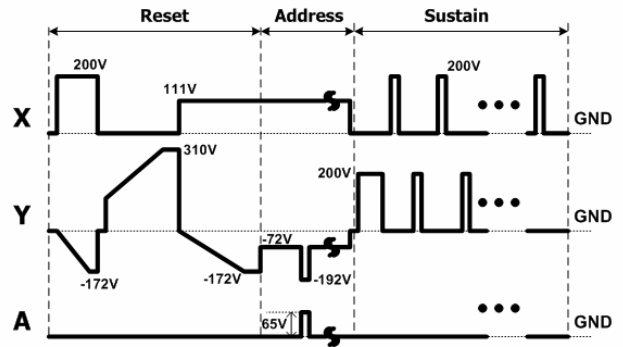

Fig. 2. Schematic diagram of the conventional driving waveform that was used in this study.

Table 1. Specifications of the 42-in AC-PDPs that Were Used in This Study.

Front Panel		Rear Panel	
ITO width	225 $\mu\text{m}$	Barrier rib width	55 $\mu\text{m}$
ITO gap	85 $\mu\text{m}$	Barrier rib height	120 $\mu\text{m}$
Bus width	50 $\mu\text{m}$	Address width	95 $\mu\text{m}$
Pixel Pitch		912 $\times$ 693 $\mu\text{m}$	
Gas chemistry		Ne-Xe-(11%)-He-(35%)	
Barrier rib type		Closed rib	

form, including the reset, address, and sustain periods employed to compare the temporal bright-image sticking of the 42-in test panels fabricated using the two aforementioned sealing methods, respectively. The frequency for the sustain period was 200 kHz, and the sustain voltage was 200 V. The detailed specifications of the two panels were exactly the same, except for the sealing process that was used. These are listed in Table 1.

### 3. Experiment results and discussion

#### 3.1 Image Sticking with a Conventional Driving Waveform for the Vacuum-sealed Panel

Fig. 3(b) illustrates the retention of a square-shaped image pattern under the ensuing full-white background image immediately after (a) a 60s sustain discharge of the 42-in test panel fabricated using the conventional sealing method, when the conventional driving waveform was applied. As shown in Fig. 3(b), the ghost image (i.e., the square-shaped image pattern) appeared due to the full-white luminance difference ( $\Delta L = 4.1 \text{ cd/m}^2$ , as shown in Table 2)

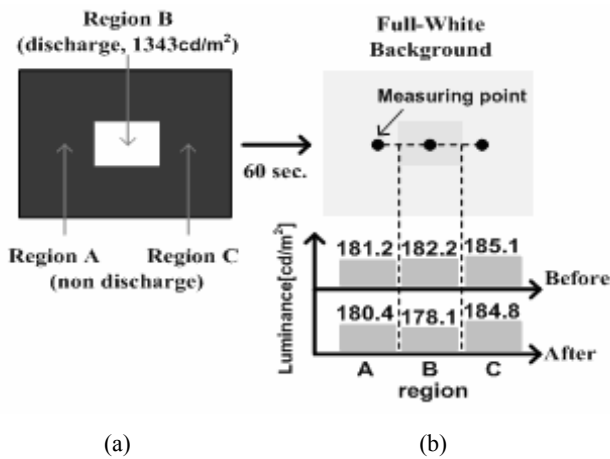
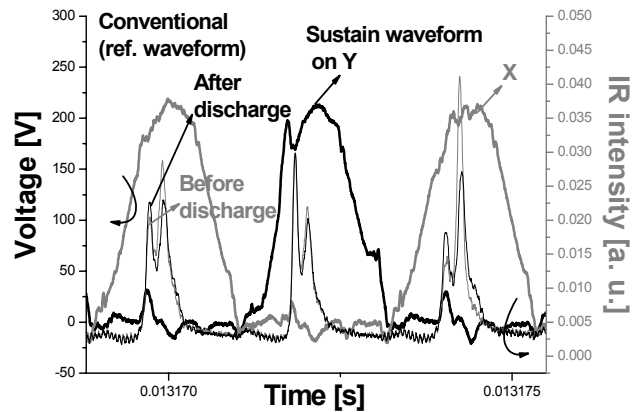

**Fig. 3.** (a) Original image pattern and (b) residual (or ghost) square-shaped pattern when displaying the full-white background captured from the 42-in panel fabricated using the conventional sealing method when the conventional driving waveform (conv.) was applied.

**Table 2.** Difference in display luminance in region B, measured before and after the sustain discharge while displaying the full-white background image when the conventional and modified driving waveforms from the 42-in panels fabricated using the conventional and vacuum sealing methods, respectively, were applied, where  $\Delta L$  is the display luminance difference.

	$L_1$ [cd/m <sup>2</sup> ]	$L_2$ [cd/m <sup>2</sup> ]	$\Delta L$ [=  $L_2-L_1$  ]
Conv.	182.2	178.1	4.1
Vac. 1	214.6	215.7	1.1
Vac. 2	186	185.7	0.3

between the cells with (after discharge) and without image sticking (before discharge) in region B, under the full-white background. Fig. 4 shows the changes in the IR (828 nm) emissions measured from region B, with and without image sticking, of the 42-in test panel fabricated using the conventional sealing method when the conventional driving waveform was applied during the sustain period. Table 3 shows the changes in the integrated values of the IR emission waveforms. As shown in Fig. 4 and Table 3, in an image-sticking cell, the IR emission and the integrated values of the IR emission waveforms were observed to be deteriorated, which indicated that the reduction of the VUV characteristics in an image-sticking cell caused the degradation of the luminance characteristics, thereby resulting in low luminance. As shown in Table 4, in the panel that had been sealed using the conventional method, the temporal bright-image sticking disappeared about 15s later.



**Fig. 4.** Changes in the IR (828 nm) emissions in region B, measured before and after the sustain discharge, when the conventional sustain waveform from the 42-in panel fabricated using the conventional sealing method (conv.) was applied.

**Table 3.** Difference in the integrated values of the IR emission waveforms calculated from the IR emission waveforms of region B in Fig. 3, Fig. 5, and Fig. 7, measured during the sustain period, when the conventional and modified driving waveforms from the 42-in panels fabricated using the conventional and vacuum sealing methods, respectively, were applied.

	Integrated Value of IR [a. u.]		
	Before Discharge	After Discharge	Difference ( $\Delta$ )
Conv.	1.25817 E <sup>-7</sup>	1.21746 E <sup>-7</sup>	0.04071 E <sup>-7</sup>
Vac. 1	1.72901 E <sup>-7</sup>	1.72448 E <sup>-7</sup>	0.00453 E <sup>-7</sup>
Vac. 2	1.45653 E <sup>-7</sup>	1.45964 E <sup>-7</sup>	0.00311 E <sup>-7</sup>

**Table 4.** Difference in the time of disappearance of the temporal bright-image sticking in region B, measured before and after the sustain discharge while displaying the full-white background image when the conventional and modified driving waveforms from the 42-in panels fabricated using the conventional and vacuum sealing methods, respectively, were applied.

	Time of Disappearance of the Temporal Bright-Image Sticking [second]
Conv.	15
Vac. 1	5
Vac. 2	0

The vacuum-sealing method with a high base vacuum level was adopted to minimize the residual gas impurity. Fig. 5(b) illustrates the retention of the square-shaped image pattern under the ensuing full-white background image immediately after (a) a 60s sustain discharge of the 42-in test panel fabricated using the vacuum sealing method when

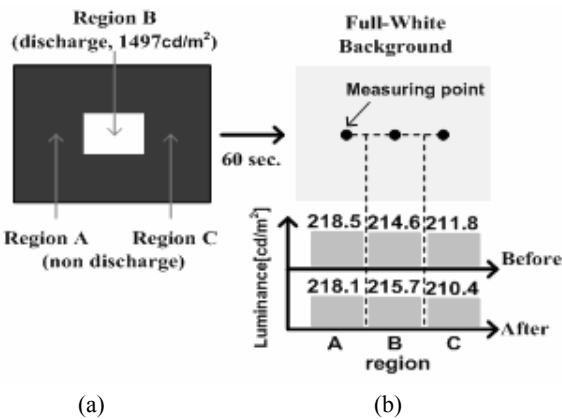

**Fig. 5.** (a) Original image pattern and (b) residual (or ghost) square-shaped pattern when displaying the full-white background captured from the 42-in panel fabricated using the vacuum sealing method when the conventional driving waveform (vac. 1) was applied.

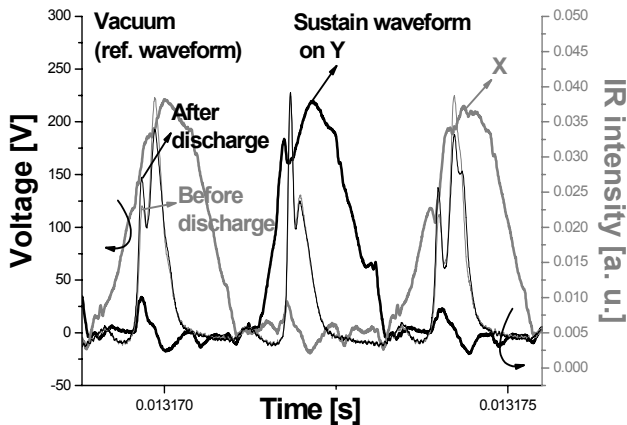

**Fig. 6.** Changes in the IR (828 nm) emissions in region B, measured before and after the sustain discharge, when the conventional sustain waveform from the 42-in panel fabricated using the vacuum sealing method (vac. 1) was applied.

the conventional driving waveform was applied. In this case, the measured display luminance difference,  $\Delta L$ , was considerably reduced to 1.1  $\text{cd/m}^2$ , as shown in Table 2. As shown in Fig. 6 and Table 3, in an image-sticking cell, the differences in the IR emission and the integrated values of the IR emission waveforms were also observed to have been reduced.

In the vacuum-sealed panel, the IR emission was intensified at the same voltage, compared to the panel that had been sealed using the conventional method, and the temporal bright-image sticking disappeared 5s later (cf. in the panel that had been sealed using the conventional method, the temporal bright-image sticking disappeared about

15s later), as shown in Table 4.

In conclusion, in the vacuum-sealed panel, the differences in luminance and integrated IR emission between the regions with and without image-sticking cells were observed to have been reduced. Furthermore, the temporal bright-image sticking disappeared faster, meaning that the image-sticking cell was recovered more easily in the vacuum-sealed panel.

### 3.2 Image Sticking with a Modified Driving Waveform in the Vacuum-sealed Panel

Since the firing voltage was observed to have been reduced in the vacuum-sealed panel [6-12], the conventional driving waveform in Fig. 2 must be modified for such panel. It is suggested that the modified driving waveform shown in Fig. 7 has a greater capacity to reduce the temporal bright-image sticking of the 42-in test panel that was fabricated using the vacuum sealing method as it minimizes the MgO damage during the sustain discharge. The modified driving waveforms in Fig. 7 have lower voltage levels compared to the conventional driving waveforms in Fig. 2. Fig. 8(b) illustrates the retention of the square-shaped image pattern under the ensuing full-white background image immediately after (a) a 60s sustain discharge of the 42-in test panel fabricated using the vacuum sealing method when the modified driving waveform was applied. In this case, the measured display luminance difference,  $\Delta L$ , was considerably reduced to 0.3  $\text{cd/m}^2$ , as shown in Table 2. As a result of the application of the modified driving waveform, the differences in the IR emission and the integrated values of the IR emission waveforms were almost the same, as shown in Fig. 9 and Table 3. In this case, temporal bright-image sticking did not occur, as shown in Table 4.

Table 5 shows the CIE chromaticity coordinates and related color temperatures measured before and after the sustain discharge for region B, for both panels. For the panel that had been sealed using the conventional method, as shown in Table 5, the x and y chromaticity coordinates and color temperatures were changed before and after the sustain discharge, whereas for the vacuum-sealed panel, the x and y chromaticity coordinates and color temperatures were almost the same before and after the sustain discharge. This result confirmed that the vacuum sealing method contributed to the prohibition of changes in the color characteristics of the light emitted from the red, green, and blue cells in the image-sticking region (region B).

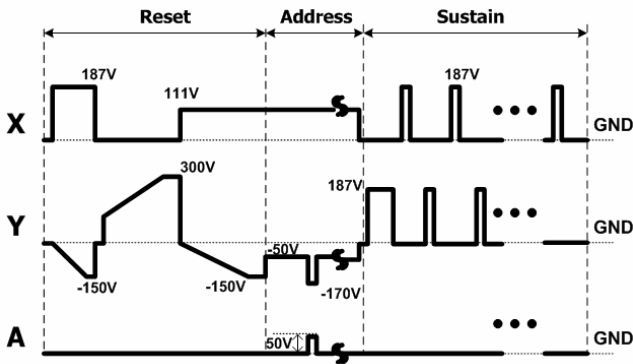

Fig. 7. Modified driving waveform for the reduction of the temporal bright-image sticking in the 42-in panel fabricated using the vacuum sealing method.

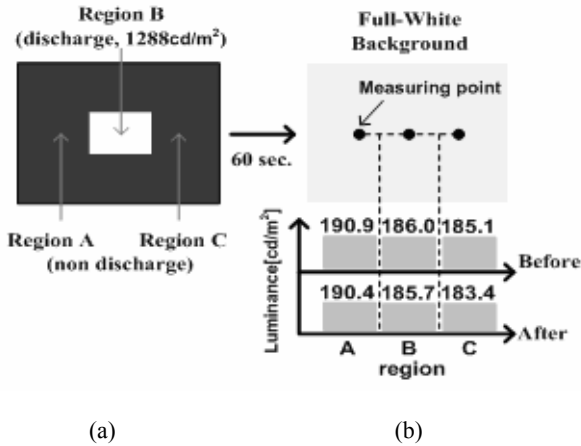

Fig. 8. (a) Original image pattern and (b) residual (or ghost) square-shaped pattern when displaying the full-white background captured from the 42-in panel fabricated using the vacuum sealing method, when the modified driving waveform (vac. 2) was applied.

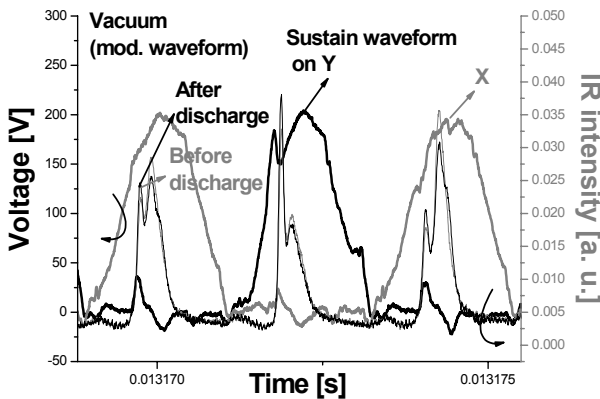

Fig. 9. Changes in the IR (828 nm) emissions in region B, measured before and after the sustain discharge, when the modified sustain waveform from the 42-in panel fabricated using the vacuum sealing method (vac. 2) was applied.

Table 5. Difference in the CIE (1931) chromaticity coordinates and color temperatures of region B, measured before and after the sustain discharge while displaying the full-white background image when the conventional and modified driving waveforms from the 42-in panels fabricated using the conventional and vacuum sealing methods, respectively, were applied.

		Conv.	Vac. 1	Vac. 2	
Before discharge	Chromaticity coordinates				
		x	0.2892	0.2806	0.2769
		y	0.2899	0.2829	0.2784
	Color, temperature, [K]	9015	10333	11250	
After discharge	Chromaticity coordinates				
		x	0.2908	0.2828	0.2764
		y	0.2920	0.2858	0.2780
	Color, temperature, [K]	8788	9909	11250	

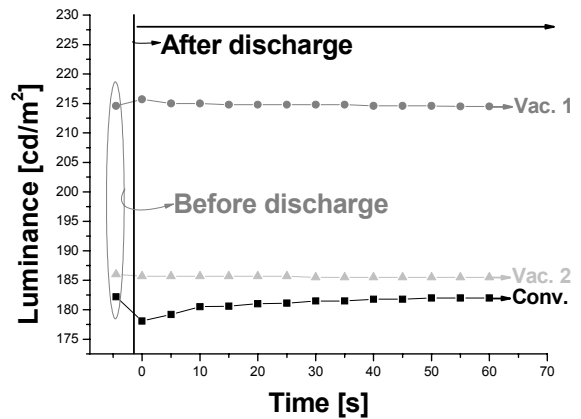

Fig. 10. Changes in luminance in region B, measured for 60s before and after the sustain discharge while displaying the full-white background image when the conventional and modified driving waveforms from the 42-in panels fabricated using the conventional and vacuum sealing methods, respectively, were applied.

Fig. 10 shows the changes in the luminance measured from region B for 60s in the regions with and without image-sticking cells while displaying the full-white background image when the conventional and modified driving waveforms were applied to such regions. As shown in Fig. 10, for the vacuum-sealed panel, the luminance values obtained from region B for 60s in the regions with and without image-sticking cells were observed to be almost the same. It is expected that this experiment result will contribute to the complete removal of the temporal bright-image sticking phenomenon in PDP TVs.

#### 4. Conclusions

The vacuum sealing method was adopted to minimize the residual gas impurities by enhancing the base vacuum level, and the resultant change in the temporal bright-image sticking was examined in comparison with the conventional sealing method in a 42-in AC-PDP with an Xe-(11%)–He-(35%) gas mixture. The experimental observation that was conducted revealed that the sealing process could affect the occurrence of temporal bright-image sticking. The application of the proper driving waveform to the vacuum-sealed AC-PDP was shown to more effectively reduce temporal bright-image sticking.

#### References

- [ 1 ] Han, J.-W., Tae, H.-S., Shin, B. J., Chien, S.-I., & Lee, D. H. *IEEE Trans. Plasma Science*, **34**, 324 (2006)
- [ 2 ] Tae, H.-S., Park, C.-S., Cho, B.-G., Han, J.-W., Shin, B. J., Chien, S.-I., & Lee, D. H. *IEEE Trans. Plasma Science*, **34**, 996 (2006)
- [ 3 ] Park, C.-S., Tae, H.-S., Kwon, Y.-K., & Heo, E. G. *IEEE Trans. Electron Devices*, **54**, 1315 (2007)
- [ 4 ] Park, C.-S., Tae, H.-S., Kwon, Y.-K., Heo, E. G., & Lee, B.-H. *IEEE Trans. Electron Devices*, **55**, 1345 (2008)
- [ 5 ] Kim, J. H., Park, C.-S., Kim, B.-S., Park, K.-H., & Tae, H.-S. *Journal of Information Display*, **8**, 29 (2007)
- [ 6 ] Kwon, S. J., Kim, J.-H., & Whang, K.-W. *Journal of Information Display*, **4**, 19 (2003)
- [ 7 ] Kwon, S. J., & Jang, C.-K. *Journal of Information Display*, **5**, 7 (2004)
- [ 8 ] Kwon, S. J., & Jang, C.-K. *Journal of the Korean Physical Society*, **47**, 371 (2005)
- [ 9 ] Park, C.-S., Tae, H.-S., Kwon, Y.-K., & Heo, E. G. *IEEE Trans. Plasma Science*, **36**, 1925 (2008)
- [ 10 ] Park, C.-S., Tae, H.-S., Kwon, Y.-K., & Heo, E. G. *In Proc. IDW'07 Dig.* (2007), p.857
- [ 11 ] Park, C.-S., Tae, H.-S., Kwon, Y.-K., Seo, S. B., Heo, E. G., Lee, B.-H., & Lee, K. S. *In Proc. SID'07 Dig.* (2007), p.1434
- [ 12 ] Park, C.-S., Tae, H.-S., Kwon, Y.-K., Heo, E. G., & Lee, B.-H. *In Proc. IMID'07 Dig.* (2007), p.320
- [ 13 ] Park, C.-S., Tae, H.-S., Kwon, Y.-K., Heo, E. G., & Lee, B.-H., *In Proc. ADMD'2007 Dig.* (2007), p.273.
- [ 14 ] Kupfer, H., Kleinhempel, R., Richter, F., Peters, C., Krause, U., Kopte, T., & Cheng, T. *J. Vac. Sci. Technol. A*, **24**, 106 (2006)