

Precision Position Control of PMSM using Neural Observer and Parameter Compensator

Jong-Sun Ko[†], Young-Ger Seo^{*} and Hyun-Sik Kim^{*}

^{†*}Department of Electronic and Electric Eng., Dankook University, Yongin, Korea

ABSTRACT

This paper presents neural load torque compensation method which is composed of a deadbeat load torque observer and gains compensation by a parameter estimator. As a result, the response of the PMSM (permanent magnet synchronous motor) obtains better precision position control. To reduce the noise effect, the post-filter is implemented by a MA (moving average) process. The parameter compensator with an RLSM (recursive least square method) parameter estimator is adopted to increase the performance of the load torque observer and main controller. The parameter estimator is combined with a high performance neural load torque observer to resolve problems. The neural network is trained in on-line phases and it is composed by a feed forward recall and error back-propagation training. During normal operation, the input-output response is sampled and the weighting value is trained multi-times by the error back-propagation method at each sample period to accommodate the possible variations in the parameters or load torque. As a result, the proposed control system has a robust and precise system against load torque and parameter variation. Stability and usefulness are verified by computer simulation and experiment.

Keywords : Permanent magnet synchronous motor, Neural deadbeat observer, Parameter compensator, Back-propagation method

1. Introduction

Recently, precision position control has become more and more important in LCD inspection of LM drives, chip mounted machines, semiconductor production machines, precision milling machines, high resolution CNC machines, precision assembly robots, high speed hard disk drivers, etc. It is merging with nanotechnology, as a part of nano-fabrication, and is also spreading to the

bio-engineering field and optical equipment. Additionally, it is very important in direct drive systems. A PMSM has replaced many DC motors since industry applications require smaller and more powerful actuators. The PMSM has low inertia, large power-to-volume ratio, and low noise as compared to permanent magnet DC servomotors having the same output rating^[1,2]. However, the disadvantages of this machine are high cost and the need for a more complex controller because of its nonlinear characteristic.

The proportional-integral (PI) controller usually used in PMSM control is simple to realize but it is difficult to obtain a sufficiently high performance in tracking

Manuscript received July 8, 2008; revised Aug. 27, 2008

[†]Corresponding Author: jsko@dku.edu

Tel: +82-31-8005-3602, Fax: +82-31-897-6104, Dankook Univ.

^{*}Dept. of Electronic and Electric Eng., Dankook Univ.

applications. A new systematic approach was done in state space using digital position information in a PMSM system^[3-6]. However, the machine flux linkage is not exactly known for a load torque observer thus creating the problem of uncertainty^[7,8]. With the cogging effect, some damage on the permanent magnet over the current can affect the value of k_t . This causes small position or speed errors and increases the chattering effect, which should be reduced as much as possible. It also makes miss-estimated load torque in deadbeat observer systems. In this paper a parameter compensator with an RLSM parameter estimator is suggested to increase the performance of the load torque observer and main controller. This compensator makes the system work as if was in a nominal system parameter. Therefore the deadbeat load torque observer has a good performance as if there was no parameter variation. Finally, this controller can be used in robot or vestibular systems which are simulators. These systems need exact sinusoidal speed control even when an unbalanced load is injected. Other production equipment can use this controller to increase production quality.

2. Modeling of PMSM

The system equations of a PMSM model can be described as

$$\dot{\omega} = \frac{3}{2} \frac{1}{J} \left(\frac{p}{2} \right)^2 \lambda_m i_{qs} - \frac{B}{J} \omega - \frac{p}{2J} T_L \quad (1)$$

$$\dot{\theta} = \omega,$$

$$T_e = \frac{3}{2} \frac{p}{2} \lambda_m i_{qs}. \quad (2)$$

where

p : number of poles

λ_m : flux linkage of permanent magnet

ω : angular velocity of rotor

J : inertia moment of rotor

B : viscous friction coefficient.

3. Control Algorithm

3.1 Position controller

A new state is defined for the tracking controller as Eqn. (3). Where ω_r is the rotor speed reference^[2]. The control input becomes Eqn. (4).

$$\dot{z} = \theta - \theta_r \quad (3)$$

$$i_{qc1} = -k_1 \omega - k_2 \theta - k_3 z. \quad (4)$$

The augmented system for the speed control of a PMSM is expressed as follows:

$$\begin{bmatrix} \dot{\omega} \\ \dot{\theta} \\ \dot{z} \end{bmatrix} = \begin{bmatrix} -\frac{B}{J} & 0 & 0 \\ 1 & 0 & 0 \\ 0 & 1 & 0 \end{bmatrix} \begin{bmatrix} \omega \\ \theta \\ z \end{bmatrix} + \begin{bmatrix} k_t \frac{p}{2J} \\ 0 \\ 0 \end{bmatrix} i_{qs} - \begin{bmatrix} \frac{p}{2J} \\ 0 \\ 0 \end{bmatrix} T_L - \begin{bmatrix} 0 \\ 0 \\ 1 \end{bmatrix} \theta_r \quad (5)$$

$$y = \begin{bmatrix} 0 & 1 & 0 \end{bmatrix} \begin{bmatrix} \omega \\ \theta \\ z \end{bmatrix}. \quad (6)$$

If the load torque T_L is known, an equivalent current command i_{qc2} can be expressed as

$$i_{qc2} = \frac{1}{k_t} T_L. \quad (7)$$

Then, the feeding forward equivalent q axis current commands the output controller and compensates for load torque effect. However, disturbances are unknown or inaccessible in a real system.

3.2 Load torque observer and MA process

It is well known that an observer is available when input is unknown and inaccessible. For simplicity, a 0-observer is selected^[4]. The system equation can be expressed as

$$\begin{bmatrix} \dot{\hat{\omega}} \\ \dot{\hat{y}} \\ \dot{\hat{T}}_L \end{bmatrix} = \begin{bmatrix} -\frac{B}{J} & 0 & -\frac{p}{2J} \\ 1 & 0 & 0 \\ 0 & 0 & 0 \end{bmatrix} \begin{bmatrix} \hat{\omega} \\ \hat{y} \\ \hat{T}_L \end{bmatrix} + \begin{bmatrix} k_t \frac{p}{2J} \\ 0 \\ 0 \end{bmatrix} i_{qs} + L \left(y - \begin{bmatrix} 0 & 1 & 0 \end{bmatrix} \begin{bmatrix} \hat{\omega} \\ \hat{y} \\ \hat{T}_L \end{bmatrix} \right). \quad (8)$$

To reduce the disadvantages of a deadbeat observer

which is too noise sensitive a moving average (MA) filter is considered [9].

$$\tilde{T}_L(k) = \frac{1}{2}(\hat{T}_L(k) + \hat{T}_L(k-1)) \quad (9)$$

3.3 Parameter estimator and compensator

The discrete dynamic equation of the PMSM can be written as

$$y(k+1) = \alpha \cdot \omega(k) + \beta \cdot y(k) + \gamma \cdot i_{qs}(k) + \delta \cdot T_L(k) \quad (10)$$

where $\alpha = \frac{J}{B}(1 - e^{-\frac{B}{J}h})$, $\beta = 1$, $\gamma = k_t \frac{P}{2J} \frac{J}{B}(h - \frac{J}{B} + \frac{J}{B}e^{-\frac{B}{J}h})$,

$$\delta = \frac{P}{2J} \frac{J}{B} (\frac{J}{B} - h - \frac{J}{B}e^{-\frac{B}{J}h})$$

Based on the assumption that there is no effect, the load torque, feed back gain and feed forward gain are defined as C_1 , C_2 and C_3 respectively [10]. The control input, to compensate for parameter variation and to make the system an equivalent nominal system, is defined as follows:

$$i_{qc}^*(k) = C_1(k) \cdot \omega(k) + C_2(k) \cdot y(k) + C_3(k) \cdot i_{qc}(k) \quad (11)$$

Therefore the resultant compensated system is equal to the nominal equivalent system.

$$\begin{aligned} y(k+1) &= \alpha \cdot \omega(k) + \beta \cdot y(k) + \gamma(C_1(k)\omega(k) + C_2(k)y(k) + C_3(k)i_{qc}^*(k)) \\ &= \alpha_n \cdot \omega(k) + \beta_n \cdot y(k) + \gamma_n \cdot i_{qc}^*(k) \end{aligned} \quad (12)$$

where α , β , γ and α_n , β_n , γ_n are actual parameters and nominal parameters, respectively. These values can be obtained easily with Eqn. (12) as $C_1 = \frac{(\alpha_n - \alpha)}{\gamma}$, $C_2 = \frac{(\beta_n - \beta)}{\gamma}$, $C_3 = \frac{\gamma_n}{\gamma}$ respectively.

Parameter compensation requires real parameter estimation [11-13]. Using a discrete system equation without disturbance Eqn. (13) a parameter and a measured parameter can be separated.

$$y(k+1) = \alpha \cdot \omega(k) + \beta \cdot y(k) + \gamma \cdot i_{qs}(k) = \theta^T \phi(k) \quad (13)$$

where $\theta^T = [\alpha \ \beta \ \gamma]$, $\phi^T(k) = [\omega(k) \ y(k) \ i_{qs}(k)]$.

An RLSM can estimate the real parameter. The resultant equations are as follows [14-16]:

$$\hat{\theta}(k+1) = \hat{\theta}(k) + F(k+1)\tilde{\phi}(k)E(k+1) \quad (14)$$

$$F(k+1) = F(k) - \frac{F(k)\tilde{\phi}(k)\tilde{\phi}(k)^T F(k)}{1 + \tilde{\phi}(k)^T F(k)\tilde{\phi}(k)} \quad (15)$$

$$E(k+1) = y(k+1) - \hat{\theta}(k)^T \tilde{\phi}(k) \quad (16)$$

where $\hat{\theta}^T(k) = [\alpha \ \beta \ \gamma]$,

$$\tilde{\phi}^T(k) = \left[\omega(k) \ y(k) \ i_{qs}(k) - \frac{\hat{T}_L}{k_t} \right],$$

$$F(0) = \frac{1}{\delta} I \quad (0 < \delta \ll 1)$$

3.4 Proposed neural network observer

The approximation of the multi-variable neural network can be done by the Hornick function method. This neural network can compensate for the effects of system parameter variations [17-19]. Fig. 1 shows a controller with a back-propagation neural network (BPNN) used which is based on an augmented state feedback [20-23].

This BPNN uses rotor speed, rotor speed reference, speed error, and equivalent q-phase current commands of the torque observer as input nodes to learn the optimal current command. The error between the real controller output and neural network propagate back to a hidden layer under the following bipolar activation function.

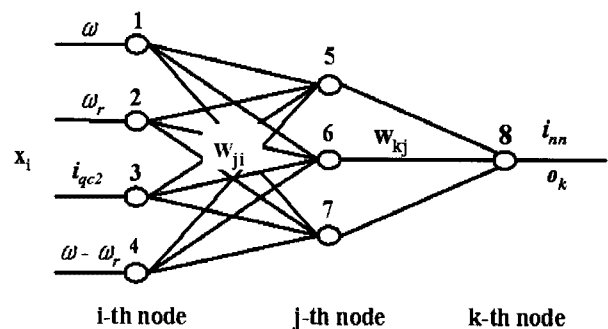

Fig. 1 Diagram of the neural network using the error back-propagation

$$f(net_k) = \frac{2}{1 + \exp(-\lambda net_k)} - 1 \quad (17)$$

$$net_k = \sum_j \omega_{kj} y_j \quad (18)$$

$$o_k = f(net_k) \quad (19)$$

The slope of the activation function is considered as 1 for simplicity and weight is changed according to the delta learning rule. Eqn. 19 represents the neural network output of the each node.

$$E = \frac{1}{2} \sum_{k=1}^n (d_k - o_k)^2 \quad (20)$$

$$\Delta \omega_{kj} = -\eta \frac{\partial E}{\partial \omega_{kj}} \quad (21)$$

where d_k is i_{qc} . A connection weight w_{kj} is a weight between j-th and k-th hidden layer is of NN. This delta rule can guarantee weight movement to the negative line of the error variation. The error signal is known as Eqn. 22 applying a chain rule. Therefore from Eqn. 17 and Eqn. 22 the error signal can be obtained as Eqn. 23.

$$\delta_{ok} = -\frac{\partial E}{\partial net_k} = -\frac{\partial E}{\partial o_k} \frac{\partial o_k}{\partial net_k} \quad (22)$$

$$\delta_{ok} = \frac{1}{2} (d_k - o_k)(1 - o_k^2) \quad (23)$$

From these results, the weighting functions are adapted by the delta learning rule as follows [24].

$$\omega_{kj}(k+1) = \omega_{kj}(k) + \eta \delta_{ok} y_j \quad (24)$$

Hidden layer weights are also changed by the same method.

$$\delta_{yj} = \frac{1}{2} (1 - y_j^2) \sum_{k=1}^n \delta_{ok} \omega_{kj} \quad (25)$$

$$\omega_{ji}(k+1) = \omega_{ji}(k) + \eta \delta_{yj} x_i \quad (26)$$

The resultant block diagram of the proposed controller is shown in Fig. 2.

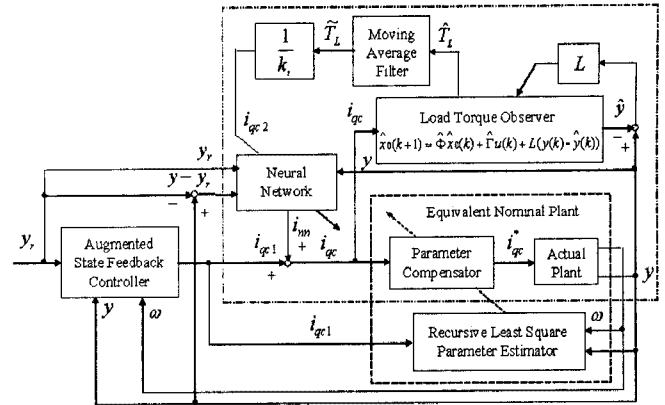

Fig. 2 Block diagram of the proposed algorithm

4. Configurations of Overall Systems

The total block diagram of the proposed controller is shown in Fig. 2. The C-Language program and a TMS320C31 DSP implement the digital control.

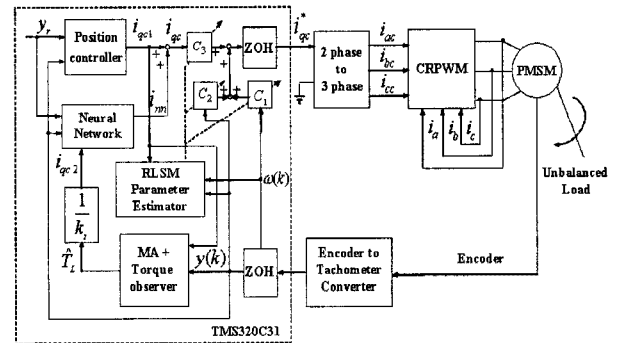
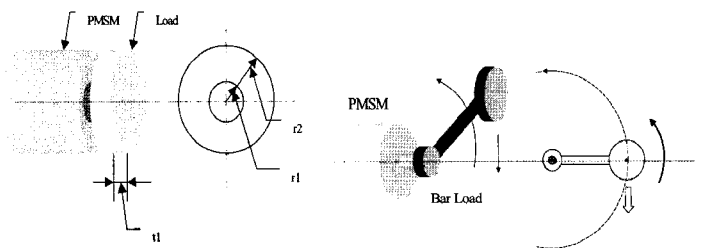

Fig. 3 Block diagram of the proposed control system

Experimental load systems directly coupled to the motor axis are depicted in Fig. 3. This system creates time varying load torque to show the effectiveness of the proposed algorithm.



(a) Inertial load (b) bar load

Fig. 4 The figure of load for parameter and load variation

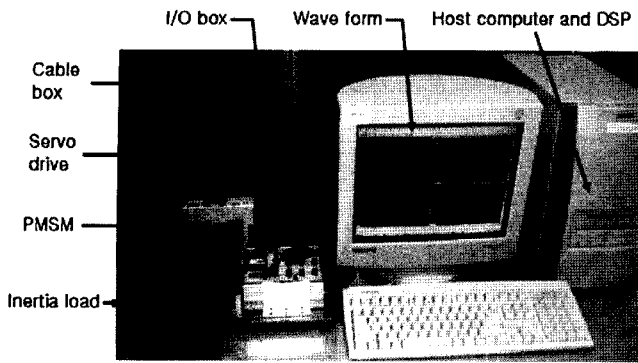

Fig. 5 The configuration of the experiment system

5. Simulation and Experimental Results

The parameters of a PMSM motor used in this simulation and this experiment are shown in Table 1.

Table 1 PMSM parameters

Power : 400 watt	Inertia : $0.363 \times 10^{-4} \text{ kgm}^2$
Rated torque : 1.3 Nm	Stator resistance : 1.07Ω
Rated current : 2.7 A	Phase inductance : 4.2 mH

The hysteresis band gap is chosen as $0.01 [A]$ and the sampling time h is determined as $0.2 [ms]$. The weighting matrix is selected as $Q = \text{diag}[0.1 \ 80 \ 30000]$, $R = 1$ and the optimal gain matrix becomes $k = [0.0773 \ 4.9807 \ 62.5080]$. The deadbeat observer and the gain matrices are calculated from nominal values. The gain is obtained using the pole placement method at origin in z domain and becomes $L = [9623.9 \ 2.7000 \ -275.20]^T$ [25]. The simulation results are shown in Fig. 5 and Fig. 6. Fig. 5 shows the speed response of the conventional controller. There is a small speed ripple and small overshoot caused by a current ripple of the hysteresis band gap and parameter variation.

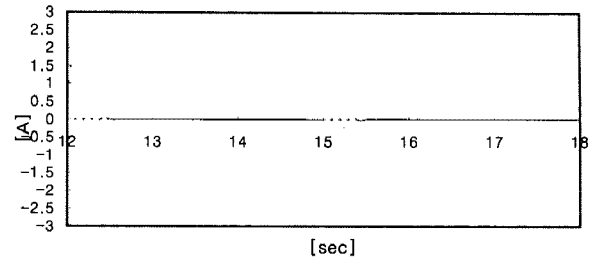
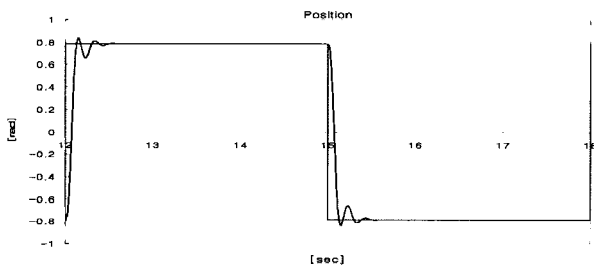

(a) Augmented state feedback

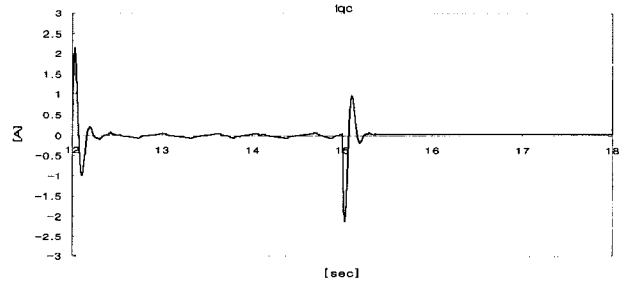
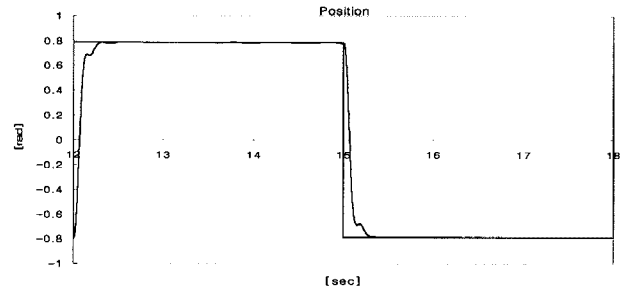

(b) Dead beat observer and parameter compensator algorithm

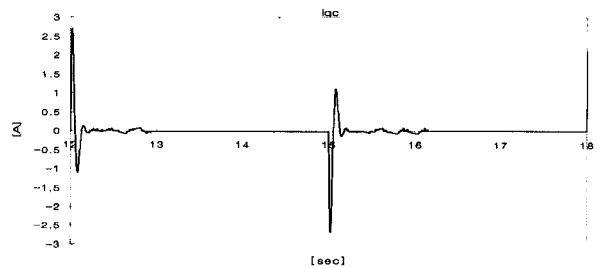
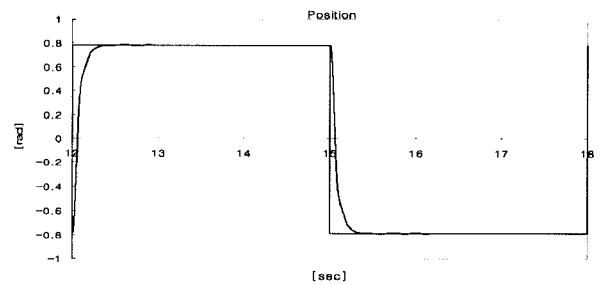

(c) Parameter compensation algorithm

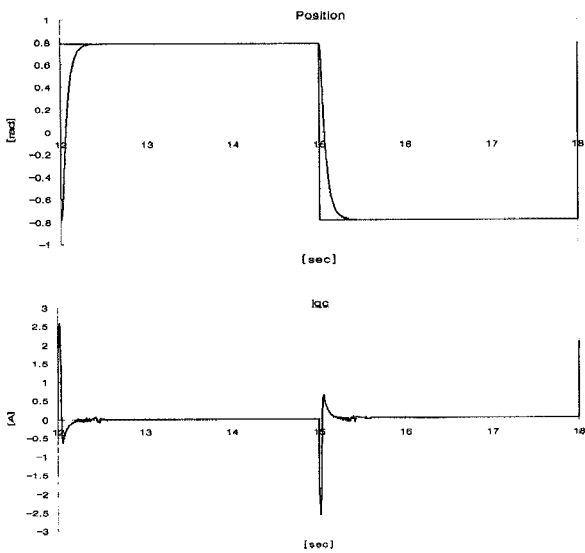

(d) Proposed algorithm

Fig. 6 Simulation results of the rotor position, q phase current command for load

The inertial parameter has 100 times the permanent magnet value and two times the R and L value. This conventional algorithm makes a large current ripple due to parameter variation. Fig. 6 shows the results of a proposed algorithm that has the same position command and same disturbance condition as Fig.4. The load effects are reduced by the proposed algorithm of the parameter compensation. In the proposed system with NN, the error is markedly decreased, more than in the case of the parameter compensation.

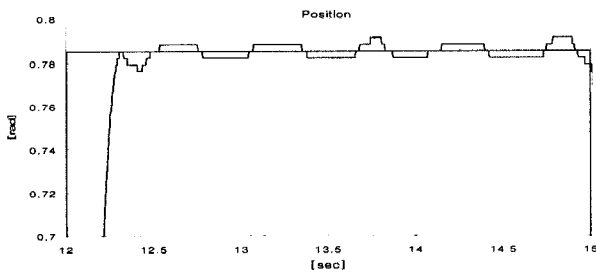

(a) Load torque observer algorithm

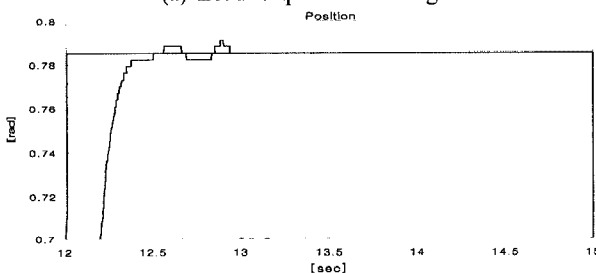

(b) Parameter compensation algorithm

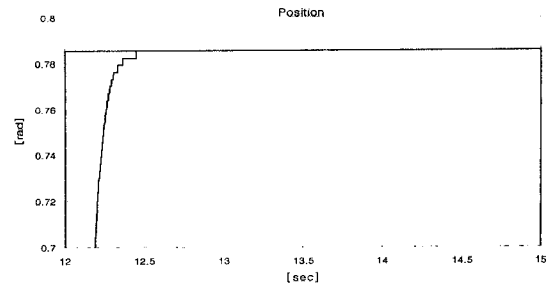

(c) Proposed algorithm

Fig. 7 Performance comparison of three controllers for the parameter variation, Zoom in the rotor position(0.7rad~0.8rad)

Fig. 7 presents 0.1[rad] scaled simulation results to show a comparison between the two controllers. The conventional controller in Fig. 7(a) has a large position ripple compared with the proposed system Fig 7(c). The parameter compensation is not as good as in the parameter compensation plus NN case. This is the result of a parameter compensator with a neural network.

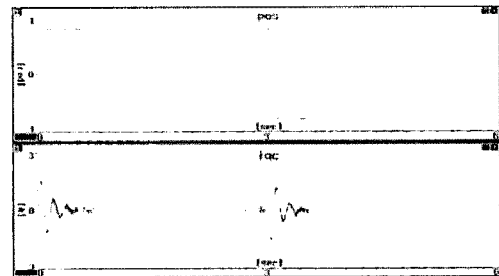

(a) Augmented state feedback algorithm

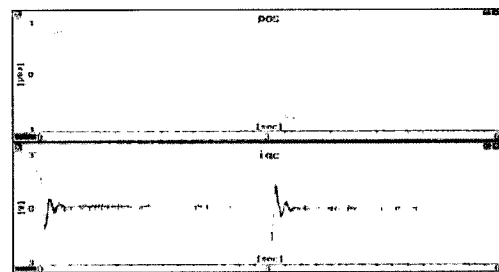

(b) Load torque observer algorithm

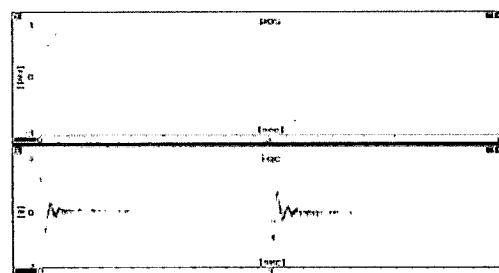

(c) Parameter compensation algorithm

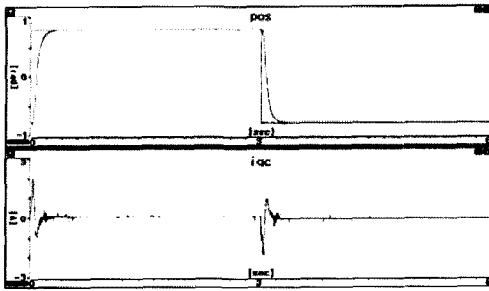

(d) Proposed algorithm

Fig. 8 Experimental results of the rotor position and q-phase current command with an inertia load

The experimental results are depicted in Fig. 8 and Fig. 9. In this experiment, real observable gains are reduced to about 30% to obtain some effectiveness in parameter compensation. The parameter compensator calculates the real parameter and compensates for current miss turned gains. Fig. 8 shows experimental results of the position with current command at about 3 seconds in duration. There is a current ripple in a steady state and large position overshoot in transient state shown in Fig. 8(a) and 8(b). However, after 20 minutes, there is no current ripple and the position error in the proposed system as shown in Fig. 8(b). A more detailed figure is shown in Fig. 9 from 0 to 20 minutes. This figure has a scale between 0.1[rad] (0.7[rad] ~ 0.8[rad]) with a zooming data and shows that position error decreases gradually as time goes on.

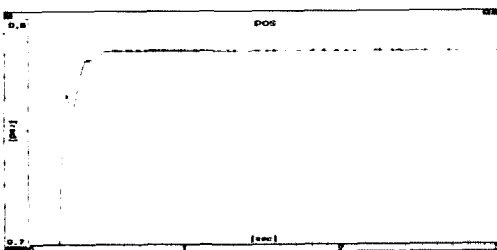

(a) Disturbance observer algorithm

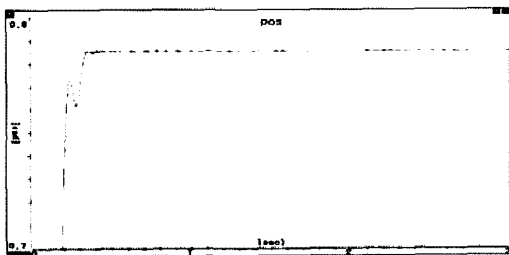

(b) Disturbance observer and parameter compensator (after one minute)

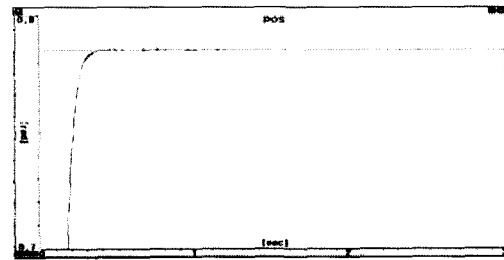

(c) Disturbance observer and parameter compensator (after twenty minutes)

Fig. 9 Experiment results of zoom in the rotor position for inertia load

6. Conclusions

A new deadbeat load torque observer with a system parameter compensator was proposed to obtain better performance from the PMSM in a precision position control system. This compensator makes a real system work as in a nominal parameter system. Therefore the deadbeat load torque observer demonstrated a good performance and acted as if there were no parameter variation. To reduce the effect of noise a post-filter was implemented by an MA process. The system response comparison was conducted between the deadbeat gain observer and the parameter compensated system with a deadbeat observer. Since the parameter compensated system acted as if there was no parameter variation, the conventional deadbeat load torque is well adapted to real systems. It can be used to cancel out steady state and transient position errors due to external disturbances, such as friction, load torque and the small chattering effect of the deadbeat control.

Acknowledgment

This work was supported by grant No.(R01-2006-000-10118-0) from the Basic Research Program of the Korea Science & Engineering Foundation.

References

- [1] D. W. Novotny, R. D. Lorentz, "Introduction to field orientation and high performance AC drives", *IEEE-IAS Tutorial Course*, 1986.
- [2] P. C. Krause, *Analysis of electric machinery*, McGraw-Hill,

- 1984.
- [3] Nandam P. K., Sen P. C., "A Comparative Study of a Luenberger Observer and Adaptive Observer-Based Variable Structure Speed Control System using a Self-Controlled Synchronous Motor", *IEEE Trans. Industrial Electronics*, Vol. 37, No. 2, pp. 127–132, 1990.
- [4] K. J. Aström, B. Wittenmark, *Computer controlled system*, Prentice Hall, International, 1997.
- [5] J. S. Ko, T. H. Lee, B. L. Park, C. W. Jeon, "Precision Speed Control of PMSM for Stimulation of the Vestibular System Using Rotatory Chair", *Transaction on KIPE*, Vol. 5, No. 5, pp. 459–466, Oct. 2000.
- [6] J. S. Ko, T. H. Lee, C. W. Jeon, S. S. Lee, "Precision Speed Control of PMSM Using Disturbance Observer and Parameter Compensator", *Transaction on KIPE*, Vol. 6, No. 1, pp. 98–106, 2001.
- [7] D. Alazard, P. Apkarian, "Exact Observer-Based Structure for Arbitrary Compensators", *Int. J. Control*, Vol. 41, No. 6, pp. 1565–1575, 1999.
- [8] J. S. Ko, S. K. Youn, "A Study of Adaptive Load Torque Observer and Robust Precision Position Control of BLDD Motor", *Transaction on KIPE*, Vol. 4, No. 2, pp. 138–143, April 1999.
- [9] C. T. Chen, *Linear System Theory and Design*, Holt, Rinehart and Winston, Inc., 1984.
- [10] C. Y. Huang, T. C. Chen, C. L. Huang, "Robust Control of Induction Motor with A Neural-Network Load Torque Estimator and A Neural-Network Identification", *IEEE Transaction on Industrial Electronics*, Vol. 46, No. 5, pp. 990–998, 1999.
- [11] K. S. Narendra, K. Parthasarathy, "Identification and Control of Dynamical Systems using Neural Network", *IEEE Trans. on Neural Networks*, Vol. 1, No. 1, pp. 4–27, 1990.
- [12] S. Chen, S. A. Billings, "Neural Networks for Nonlinear Dynamic System Modeling and Identification", *Int. J. Control*, Vol. 56, No. 2, pp. 319–346, 1992.
- [13] Tanaka K, Yuzawa T, Moriyama R, Miki I., "Initial Rotor Position Estimation for Surface Permanent Magnet Synchronous Motor", *Record of Thirty-Sixth Industry Applications Conference*, Vol. 4, No. 30, pp. 2592–2597, 2001.
- [14] J. D. Landau, *System Identification and Control Design*. Englewood Cliffs, NJ, Prentice-Hall, 1990.
- [15] G. C. Goodwin, K. S. Sin, *Adaptive Filtering Prediction and Control*. Englewood Cliffs, NJ, Prentice-Hall, 1984.
- [16] Faa-Jeng Lin, Po-Hung Shen, Ying-Shieh Kung, "Adaptive Wavelet Neural Network Control for Linear Synchronous Motor Servo Drive", *IEEE Transaction on Magnetics*, Vol. 41, No. 12, pp. 4401–4412, 2005.
- [17] Fukuda, T., Shibata, T., "Theory and Application of Neural Networks for Industrial Control Systems", *IEEE Trans. on Industrial Electronics*, Vol. 39, No. 6, 1992.
- [18] J. O. P. Pinto, B. K. Bose, L. E. B. da Silva, "A Stator Flux Oriented Vector-Controlled Induction Motor Drive with Space Vector PWM and Flux Vector Synthesis by Neural Networks", *IEEE Trans. Ind. Applicat.*, Vol. 37, pp. 1308–1318, 2001.
- [19] Yang Yi, D. Mahinda Vilathgamuwa, Azizur Rahman, "Implementation of an Artificial-Neural-Network-Based Real-Time Adaptive Controller for an Interior Permanent-Magnet Motor Drive", *IEEE Trans., Ind. Applic.*, LA-39, No. 1, pp. 96–104, 2003.
- [20] Naomitsu Urasaki, Tomonobu Senjyu, Toshihisa Funabashi, Hideomi Sekine, "An Adaptive Dead-time Compensation Strategy for a Permanent Magnet Synchronous Motor Drive Using Neural Network", *Journal of Power Electronics*, Vol. 6, No. 4, pp. 279–289, Oct. 2006.
- [21] Naomitsu Urasaki, Tomonobu Senjyu, "High Efficiency Drive Technique for Synchronous Reluctance Motors Using a Motors Using a Neural Network", *Journal of Power Electronics*, Vol. 6, No. 4, pp. 340–346, Oct. 2006.
- [22] Mona N. Eskander, "Neural Network Controller for a Permanent Magnet Generator Applied in Wind Energy Conversion System", *Journal of Power Electronics*, Vol. 2, No. 1, pp. 46–54, January 2002.
- [23] Mona N. Eskander, "Minimization of Losses in Permanent Magnet Synchronous Motors Using Neural Network", *Journal of Power Electronics*, Vol. 2, No. 3, pp. 220–229, July 2002.
- [24] Fayez Fahim El-Sousy, "A Vector-Controlled PMSM Drive with a Continually On-Line Learning Hybrid Neural-Network Model-Following Speed Controller", *Journal of Power Electronics*, Vol. 5, No. 2, pp. 129–141, April 2005.
- [25] J. S. Ko, J. H. Lee, S. k. Chung, M. J. Youn, "A Robust Position Control of Brushless DC motor with Dead Beat Load Torque Observer", *IEEE Transaction on Industrial Electronics*, Vol. 40, No. 5, pp. 512–520, 1993.



Jong-Sun Ko was born in South Korea in 1960. He received his B.S. degree from Seoul National University, Seoul, South Korea, in 1984, and his M.S. degree from Korea Advanced Institute of Science and Technology (KAIST), Taejeon, South-Korea,

in 1989. He received his Ph.D. in Electrical Engineering at KAIST in 1994. He has been with the Production Engineering R&D Center of Samsung Electronics Co. from 1983 to 1996. He was a visiting scholar at the University of Tennessee in 1999. He was a Prof. of Electric & Electronic Engineering in Wonkwang University, Iksan, South Korea from 1996 to 2003. He has been a professor of Electronic and Electric Engineering in Dankook University, Seoul, South Korea since 2003. His research interests are in drive systems, digital control, robust control, and factory automation. He is a member of IEEE, KIEE and KIPE. He has done projects with the Samsung Company and other universities in the field of automatic production, automatic controllers, PMSM controllers, and Torque Observers for PMSM.



Young-Ger Seo was born in South Korea in 1982. He received his B.S. degree from Dankook University, Seoul, South Korea, in 2007. He is currently a M.S. student at Dankook University. His research interests are in motor drive controls, development of simulators and wind power systems.



Hyun-Sik Kim was born in South Korea in 1978. He received his B.S. degree in Electrical Engineering from Wonkwang University, South Korea, in 2004. He received his M.S. degree from Dankook University. He is currently working towards his Ph.D. at Dankook University. His research interests are in drive systems, digital control, and control of AC motors.