

A Study on s-INS for Small and Medium-Sized Ships

Nam-Kyu Park, Joo-Young Kim and Woo-Chul Kim, *Member, KIMICS*

Abstract—With regard to a marine safety system, large vessels are generally loaded with INS (Integrated Navigation System). But although small and medium-sized ships are exposed to safety accidents in the sea, they are not carrying proper navigation devices and equipment.

Accordingly, in order to develop INS for small and medium-sized ships(s-INS), an existing INS has newly been organized and integrated. Recently, more strict enforcement of INS-related regulations is expected at home and abroad, and the scope of their applications is being broadened. To keep up with this global trend that ships are being loaded with digital devices and equipment, this study has tried to develop s-INS, broadening its applications, and suggesting a future research plan.

Index Terms—INS, s-INS, AIS, VMS, Navigation, LBS, ATA, VDR

I. INTRODUCTION

A. Necessity of Research

Recently, digitalization is being accelerated in the shipbuilding and marine field. Moreover, ships are required to be loaded with digital equipment by IMO (International Maritime Organization).

Generally large vessels are well equipped with digital based INS for maritime safety, but in case of most small and medium-sized ships, which are much more likely to suffer from marine accidents, they are not equipped with a pertinent marine safety system. In spite of the fact that a digital based INS is badly needed for small ships, it has been impossible due to excessive investment. Moreover, existing INS is usually designed for medium and large-sized vessels, and so it is not easy for small ships to use it. Therefore, as a solution to these problems, this study aims to develop the s-INS for small and medium-sized ships, making a contribution to the development of marine devices and equipment in order to prevent marine accidents, and also minimizing the damages coming from perils of the sea.

In this study, researches have been made to compare and analyze INS-related devices and equipment. From the aspect of system development, software, and hardware, the difference between existing INS and s-INS have been checked, while pointing out the characteristics of s-INS in its design and system development. During the development period, this study has succeeded not only in developing an integration interface module for navigation and communication devices and equipment that is essential to the small and medium-sized ships, but also in designing a display device available and suitable to the small-sized ships. This study has focused on developing the software for a simplified electronic chart system, that is to say, s-INS. And then application integration has been conducted. While observing recent developments at home and abroad, literature review has been conducted, and intensive researches on references have been made. Besides, the development process of s-INS, the function of the system, and its hardware and software structure has been discussed. The usage of s-INS and the evaluation of development system have been presented, while suggesting a future research direction.

The definitions of terms in this study are as follows:

s-INS (small-Integrated Navigation System) means a small integrated navigational system designed for small and medium-sized ships.

ECDIS refers to an Electronic Chart Display and Information System.

II. BASIC RESEARCH

A. Recent Trends of Maritime Equipment

The IMO under the UN recommends that SOLAS (Safety of Life at Sea) ships should gradually carry ECDIS (Electronic Chart Display and Information System) starting from 2008, and also continues to make efforts to advance the enforcement of related regulations and standards through various international conferences. Countries in the Baltic, Panama Canal, Suez Canal, and the Strait of Malacca are strengthening their regulations concerning the passage of ships such as an oil tanker through the territorial sea, thus trying to compel ships to carry ECDIS.

In addition to this trend, because of the convenience of ENC [3] (Electronic Nautical Chart), young sailor's familiarity with information technology, and the facilitation of navigational duties, ECDIS is becoming a necessity of ship's navigation [9].

Manuscript received May 28, 2007. (Write the date on which you submitted your paper for review.)

Nam-Kyu Park, Joo-Young Kim and Woo-Chul Kim

Distribution Management Department, Tongmyung University(Email:nkpark@tu.ac.kr)

Along with the global trend for marine safety, maritime environmental conservation, and innovation in the marine logistics, many countries are making every effort to introduce and develop a state-of-the-art navigational system, and to keep abreast with the times, Korea also, based on its strong IT infrastructure and high technologies, takes the lead in developing a digital navigational system of ENC and ECDIS.

In line with the visible timetable of introducing both ENC and ECDIS to the SOLAS ships, the IMO and IHO (International Hydrographic Organization) have held an international seminar on ENC and ECDIS, discussing concrete and diverse measures including standardization, introduction of international standards, education and training, and the type approval of ENC-related navigational devices and equipment.

In an effort to prevent the perils of the sea through introduction of digital devices and equipment, Korea, a leader in the shipbuilding and marine field, is actively participating in the international treaties and conferences on navigational safety.

From a long time ago, Russia, United Kingdom, and Hong Kong have been implementing their plans for the computerization of a navigational chart to prevent marine accidents, the suggestion of an optimal route, and position tracking of ship's routes. Also, heated discussions have been followed in order to adopt their own ENC as standard of IMO.

From 2002, it has become an obligation for ocean-going ships to carry an AIS (Automatic Identification System). IMO had recommended that the ships should be loaded with VDR (Voyage Data Recorder) and ATA (Automatic Tracking Aids). The ENC and ECDIS, for which many researches have been made for a long time in connection with AIS, VDR, and ATA, are expected to play an important role as a practical assistance system, drawing keen attention, and causing fierce competition in developing them [6].

Beginning with express passenger ships in 2008, IMO plans to enforce all ships to be loaded with ENC-related devices and equipment until 2012. Therefore, domestic shipping companies are required to pay deep attention to it and to prepare for it [5].

The Ministry of Maritime Affairs and Fisheries has enacted the "Regulations on Ship's Position Report" in March 2006, and put them into practice in September of the same year [7]. IMO has already held meetings to discuss detailed criteria on the operation and technical requirements of LRIT (Long-Range Identification and Tracking of Ship) of SOLAS.

Owing to the importance of navigation communication system and because of more strict regulations on ship's safety and expanded installation of devices and equipment, the R&D on s-INS carries much importance and is required to be developed as soon as possible.

B. Analysis of Existing INS

The traditional navigation communication system for

small and medium-sized ships is mainly composed of products with a single individual function. And in particular, in case of foreign-made products, their prices are so high that they were not be able to be widely supplied. s-INS related products include the followings: ECDIS, medium-sized digital radar, AIS, weather fax, fish finder, and echo sounder.

However, all these products are mainly applicable to medium and large-sized vessels, being relatively high-priced, having restricted information of its own, and consequently providing limited practicality.

Table 1 shows the details of an existing navigation communication system.

Table 1 Analysis of INS-related existing products

Company name	Location	Main products	Characteristics
Samsung Heavy Industry	Geoje	ECDIS, INS	Excellent safety of product (DNV) To be used for its own shipbuilding Leader in the domestic shipbuilding-technology Developed for large-sized vessels
Haeyang Information	Seoul	GPS plotter Fish finder	Excellent safety of product (established in '69) Leader in the domestic shipbuilding materials Production of unit items
Saracom	Busan	GPS plotter Fish finder	Plotter/ No. 1 in the market share of fish finder Production of unit items
Furuno	Japan	Radar, GPS plotter	Low and medium-priced products Production of all kinds of navigation communication devices and equipment Radar + fish finder + plotter
Transas	U.K./ Russia	ECDIS, INS	World-class quality INS and system integration
Saab	Sweden/ Canada	AIS, ECDIS	Leader in AIS standardization Joining hands with ECDIS specialist ICAN of Canada Have difficulty in customization

Considering the fact that small and medium-sized ships have difficulty in equipping themselves with a navigation communication system, the development of a s-INS suitable to small and medium-sized ships is badly needed.

C. Literature Review

By capitalizing on the satellite broadcasting via a satellite, Bae Jeong-Cheol has made researches on the development of TV antenna for ships. He has made a great contribution not only to technical development, but also improvement of sailor's welfare [1].

Yun Jae-Jun and Choi Jo-Cheon has tried to digitalize the location report of a fishing boat, making efforts to realize the data base of VMS (Vessel Monitoring System) by considering regional wave environment, fishing area and boundary, and traffic volume. Also they have made researches on the establishment of fishing information network and automatic transmission of fishing boat's location information [10].

Kim Byeong-Ok, said in his study on setting up a wireless communication network for ship's position tracking system that if VMS is installed using only AIS, such problems as heavy traffic and unclear discretion can

happen. And he added that by using TRS (Trunked Radio Service) system, location information and voice communication can be obtained simultaneously, and also it is portable and suitable for small ships and fishing boats below 5 tons [4].

Until now, this study has reviewed INS-related recent developments, also conducted literature review. As shown in the above, INS plays an important role for the safe navigation of ships, and many researches are being actively made. Considering the situation, this study has aimed to develop a s-INS for small and medium-sized ships which cannot afford to carry an INS.

III. INTERNATIONAL STANDARDS RELATED TO INS

A. INS Configuration

INS is composed of ECDIS, autopilot, ATA, GPS, echo sounder, AIS, and conning display system, and each navigation and communication system has its own console system, at the same time connected to the ECDIS and conning display, so that an overall control function can be performed in the ECDIS and conning display.

Each individual navigation and communication system included in the INS is in compliance with international standards provided by IMO, IEC, and ITU. Also, their reference for connection and integration depends on IEC 61162-1. The system configuration of INS is illustrated in the Figure.1.

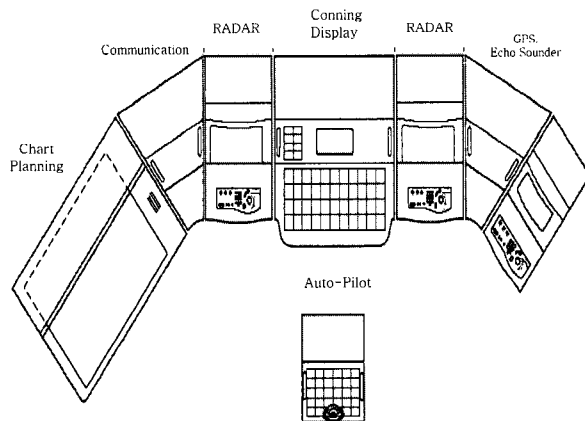

Fig. 1 System configuration of INS

B. ECDIS

ECDIS is a core component of INS. It gathers related information from each individual navigation and communication system and performed an overall control function.

The performance standards of ECDIS have been adopted at the 19th general meeting of IMO that was held in November 1995. In order to satisfy SOLAS V/20 of IMO standards, the hardware, function, and data of ECDIS are required to meet the following specifications described in the next section [2].

1) Hardware Requirements

• Indicator

The optimal size of chart display should be at least 270 X 270 mm. In accordance with the color and resolution specifications described in the special publication 52 of IHO appendix 2, the indicator has to meet 16 colors and 1000 X 1000 pixels.

• Interfaces

Along with a magnetic compass and a speed indicator, ECDIS is required to be connected to two individual location detection devices.

• Power Source Supply

ECDIS and related devices for its ordinary use are required to be able to be operated under an emergency power system according to the chapter 2-1 of SOLAS 1974. Also, all devices are needed to be able to be handled during a power outage for 45 seconds without re-initialization.

• Back-up System

As a fail-safe in time of trouble, ECDIS is needed to be equipped with a back-up system for safe navigation.

2) Software Requirements

• Indicator

North-up and true motion[8] are needed to be offered along with other modes. Radar information should also be offered in the ECDIS indicator. Referenced colors and symbols of IHO are required to be used when ECDIS indicator displays the data of official route features.

• Regulator

ECDIS operator can add some features to the indicator or remove others from it, but should not be allowed to erase the features registered in the display base.

• Route Planning

ECDIS should be able to define route segments, waypoints, and alternative routes, and also it should be able to check perilous sections and safe isobath, while recording off-track alarms in the planned routes.

• Route Monitoring

Along with continuous vessel monitoring, ECDIS should be able to issue an alarm in time of vessel's position change and dangerous situations, and also provide the navigational tools such as an indication of direction and distance.

• Alarm and Indicators

Standards require that ECDIS should be able to give an audible and visual alarm signal as well as a visual indication under the 15 kinds of conditions described in the standards.

• Recording of Navigational Data

At an interval of one minute, ECDIS is required to be able to keep record of time, location, vessel direction, speed, chart data source, edition, date, cell, and update history of the past 12 hours. Navigational data should not be erased by an operator.

3) Chart Data Requirements

• Source Data

The navigational chart data of ECDIS should be provided by member countries approved by Korean government, and should follow IHO standards.

• Update

ECDIS should be able to accept official updates and manual updates, and also apply them to the indicator. Updates should be kept separately from chart data, and original chart data should not be altered.

IV. S-INS DEVELOPMENT CONTENTS

A. s-INS Configuration

Because of financial difficulty and limited space, the small and medium-sized ships cannot afford to be equipped with all the devices and equipment that are required in the INS standards. Considering these facts, this study has tried to integrate effectively many navigation and communication devices and equipment, so that it could be practically used for small and medium-sized ships. This new system is a simplified ECDIS-based (ECS: Electronic Chart System) one, namely, s-INS.

To cope with maritime environments filled with salt, humidity and shaking, s-INS has a waterproof, shockproof, solid body, equipped with integration interface module linked to all the navigation and communication devices and equipment, and based on ECS. Figure.2 shows the concept chart of s-INS.

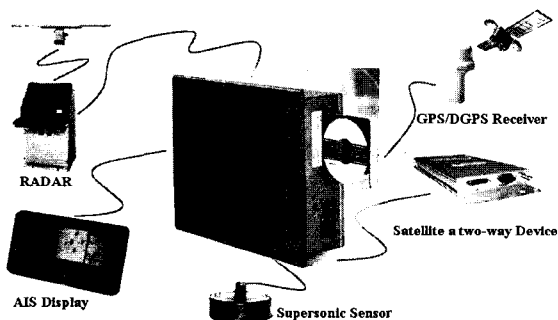

Fig. 2 Concept chart of s-INS

The configuration of s-INS is similar to 1.3 GHz CPU. s-INS is embedded with 10G HDD, 7" touch screen, and 7" color TFT LCD. Figure.3 illustrates details of s-INS.

Hardware structure is divided into two parts: an integrated control board that handles the signals coming from various sensors and the hull part that has endurance and is shockproof. Table 2 shows the hardware structure of s-INS.

Table 2 Hardware structure of s-INS

	Scope of Development	Target Performance and Specifications	Major Function
Hardware	Integrated control board	• NMEA 0183 Signal handling • Ultrasonic signal A/D conversion	Signal handling coming from various sensors
	Hull	IEC 60945 referenced	Endurance, Shockproof

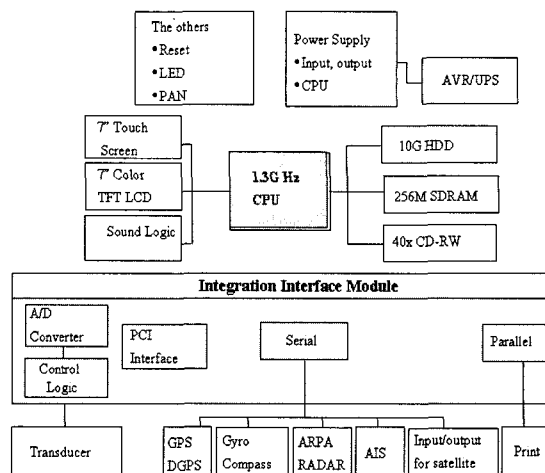

Fig. 3 s-INS Hardware Configuration

B. s-INS Software Functions

Originally INS has main function which is integration with measurement the ships position and depth, alarm monitoring of equipments, communication and steering. On the other side, s-INS was focused on the integration with ships position, depth, identification and communication, which these functions are necessary for small ship.

Accordingly s-INS has developed a simplified electronic navigational chart, vessel monitoring system, fish finder, echo sounder, input and output module for satellite transponder communications, AIS display devices, radar repeater, and integrated software. More details are shown in the following Table 3.

Table 3 Software functions

	Scope of Development	Target Performance and Specifications	Major Functions
Software	ECS/VMS	IEC 61174 and IHO S-52 referenced	ENC display, Navigation planning, location report
	Fish finder/Echo sounder	50/200KHz, 5~400M, within 1M	Fish finding and Echo sounding
	Input/output module for satellite transponder communications	TIFF conversion of Weather fax	TIFF conversion of Weather fax
	AIS display device	IHO S-52 referenced	Automatic Identification of sailing ships
	Radar repeater	IEC 60872-3 EPA referenced	Target tracking, Alarm setup
	Integrated software	Integrated operation of each module	Integrated operation of each module

C. Simplified Electronic Chart Data

Now, let's see the main functions of simplified electronic data developed in this study.

1) Source Data Collection Function

The electronic chart data of s-INS is presented and converted in compliance with S-57 and S-52 of IHO, but has been reorganized according to the hardware and OS of s-INS. To this end, a new kernel has been developed for the generation and display of electronic chart data.

The development algorithm of this new system is shown in the next Figure.4.

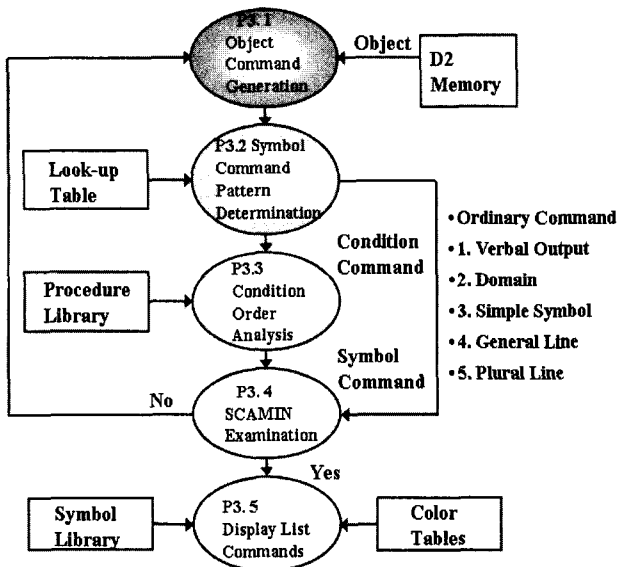

Fig. 4 Development Algorithm

2) Update Function

Like ECDIS, the electronic chart data of s-INS is based on ENC and is able to be updated both on an official basis and manual basis. Updated data is to be displayed on the indicators, and then is to be filed away separately. At the same time, original chart data has been made not to be altered.

3) Chart Viewer

The new chart viewer takes less than 0.5 second in browsing after changing the map scale of 1: 30,000,000 (the initial map scale of ENC in which 15 sheets of maps are overlapped) to a large scale of 1: 30,000 as shown in the below Figure.5 and Figure.6. This viewing system has been proved to have excellence performance.

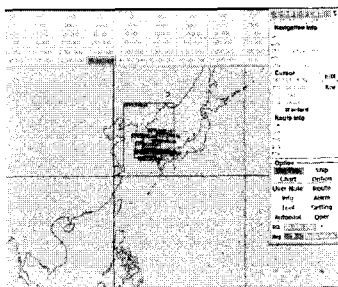

Fig. 5 1:30,000,000 scale

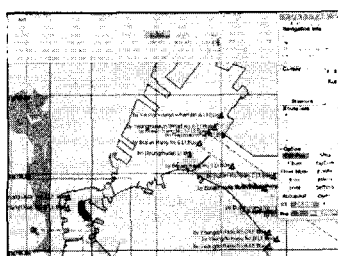

Fig. 6 1:30,000 scale

IV. CONCLUSION

A. System Evaluation

S-INS is an integrated system of existing navigation communication system with a 7 inch LCD pattern. It is reported that s-INS is rated as a useful product for small and medium-sized ships. As it has been developed by independent technology, it has price competitiveness along with technical innovation and technical difference. By increasing the practicality of INS-related existing technology, this technology carries significance as a next generation growth industry.

S-INS can be used not only for fishing boats in the coastal area but also for deep-sea fishing boats, feeders, coastal ships, passenger ships, and leisure boats. Considering the current trend that ships are required to be equipped with digital devices and equipment, this economical s-INS can be widely used, while lowering our high dependence on foreign-made marine communication devices and equipment. At the same time, it will make a contribution to securing the core technology of LBS (Location-Based Services) system in the marine field. Furthermore, it is expected that this simplified s-INS engine development will accelerate the system development for domestic shipbuilding materials suppliers.

B. Limit of This Study and Future Research Plan

In order to increase the practicality of s-INS, satellite communication terminal's correspondence with other countries' satellites should be made smooth. Meanwhile, as ships are always being shaken and tossed in the sea, the hard disk of operation system should be replaced by flash memory. Also, as a way of saving correspondence, VHF (Very High Frequency) is preferred, but the range of its correspondence is limited to 30 miles. Therefore, in order to overcome this limit, more researches are needed to be made, so that it may raise the output power of transmission and reception at a low cost. Also we will continue to make researches on its related technologies.

ACKNOWLEDGMENT

This work is financially supported by the Ministry of Education and Human Resources Development (MOE) and the Ministry of Commerce, Industry and Energy (MOCIE) through the fostering project of the Industrial-Academic Cooperation Centered University.

REFERENCES

[1] Bae Jeong-Cheol, Korea Institute of Maritime Information and Communication Sciences, academic papers, 1126-6981, vol. 7 no. 6, pp. 146-1152, 2003.
 [2] IEC 611745, IEC 61162-1, IEC 60945, IHO S-52, IHO S-57.

- [3] For ship's safe navigation, a paper chart includes information on a coastline, isobath, water depth, danger sign, and route boundary. Each country produces a digital chart according to the international standard of S-57. This chart is usually referred to an ENC (Electronic Navigational Chart).
- [4] Kim Byeong-Ok, Korea Institute of Maritime Information and Communication Sciences, Academic Journal for Spring Season Academic Meeting, pp. 228-231, 2006.
- [5] Lee In-Hae, Maritime Korea.
(<http://www.monthlymaritimekorea.com>) Jan. 31, 2006.
- [6] Maritime Korea
(<http://www.monthlymaritimekorea.com>) March 30, 2006.
- [7] The Ministry of Maritime Affairs and Fisheries, The Law for Ship's Safety, subsection 3 of section 4 (ship's transmitter). Revised on March 24, 2006, and took effect on September 24, 2006.
- [8] This method has, for the first time, been introduced by Decca in 1956. If a speed log has an input data of the mother ship's speed or if an operator inputs the data on speed directly, the "tail" of the mother ship and other ships shows their actual speed and course. In this method, the mother ship moves on the screen, and so in case of a conventional radar system, this method can be an optimal solution for ship control.
- [9] Vessel Traffic Service Center: "Navigation and Chart (4)," September 18, 2002.
- [10] Yun Jae-Jun, Choi Jo-Cheon, Korea Institute of Maritime Information and Communication Sciences,

academic papers, 1226-6981, vol. 7 no. 7, pp. 1387-1392, 2003.

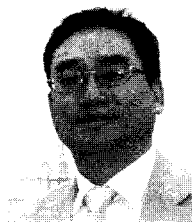

Nam-Kyu Park

Mar.77-Fer.81 Korea Maritime University Department of nautical science bachelor of engineering. Mar.84-Fer.87 Korea Maritime University Department of shipping management master of business administration. Mar.92-Fer95 Korea

Maritime University Department of shipping management doctor of business administration. Mar.81-Sep.83 Chun-Kyung shipping company first mate. Nov. 87-Jul.95 Korea Advanced Institute of Science and Technology a senior researcher. Mar.96-Mar.05 Tong-myong University of Information Technology an associate professor. Dec.99-Dec.00 Tong-myong University of Information Technology the academic affairs officer. Dec.00 -Mar.06 Tong-myong University of Information Technology a professor. Mar.06-Now Tong-myong University a professor.

※ Concerning fields : Positioning, Targeting & Tracing based on real time system, Supply Chain Management, Electronic Chart System, Dynamic Planning and Operation System.