

# Comparison of Temporal Dark Image Sticking Produced by Face-to-Face and Coplanar Sustain Electrode Structures

Jae Hyun Kim\*\*, Choon-Sang Park\*\*, Bo-Sung Kim\*\*, Ki-Hyung Park\*\*, and Heung-Sik Tae\*

## Abstract

The temporal dark image sticking phenomena are examined and compared for the two different electrode structures such as the face-to-face and coplanar sustain electrode structure. To compare the temporal dark image sticking phenomena for both structures, the differences in the infrared emission profile, luminance, and perceived luminance of the image sticking cells and the non image sticking cells were measured. It is observed that the temporal dark image sticking is mitigated for the face-to-face structure. The mitigation of the temporal dark image sticking for the face-to-face structure is due to the slight increase in the panel temperature induced by the ITO-less electrode structure.

**Keywords :** ac-PDP, temporal dark image sticking, face-to-face sustain electrode

## 1. Introduction

Plasma display panel is considered to be a suitable device for the flat panel device for a digital high definition television. However, plasma display panel still has some critical problems such as image sticking. Image sticking is a phenomenon where a previously displayed image appears as a residual image in a consecutive image display when the previously displayed image was displayed continuously over a few minutes [1]. Although the iterant strong discharge during a sustain period is known to induce an image sticking problem, the image sticking problem is still not fully understood [1, 2, 3]. As such, this paper focuses on the temporal dark background image-sticking problem. Our experimental observation illustrates that the discharge cell structure, especially electrode structure, is closely related to the temporal dark image sticking phenomenon. **The face-to-face** sustain electrode structure reduces image sticking due to the decrease in the panel-temperature caused by the elimination of the ITO electrode [4].

Therefore, this paper proposes the face-to-face structure for reducing temporal dark image sticking. In addition, the image sticking characteristics of the face-to-face structure are compared with that of the conventional coplanar electrode structure.

## 2. Experiments

Fig. 1 shows the full high definition (full-HD) grade test panel and measurement systems employed in this experiment. The spectrometer (PR-715) and the photo-sensor amplifier (Hamamatsu C6386) were used to measure the changes in the luminance and IR (Infrared) emission during a reset-period, respectively. Signal generator and

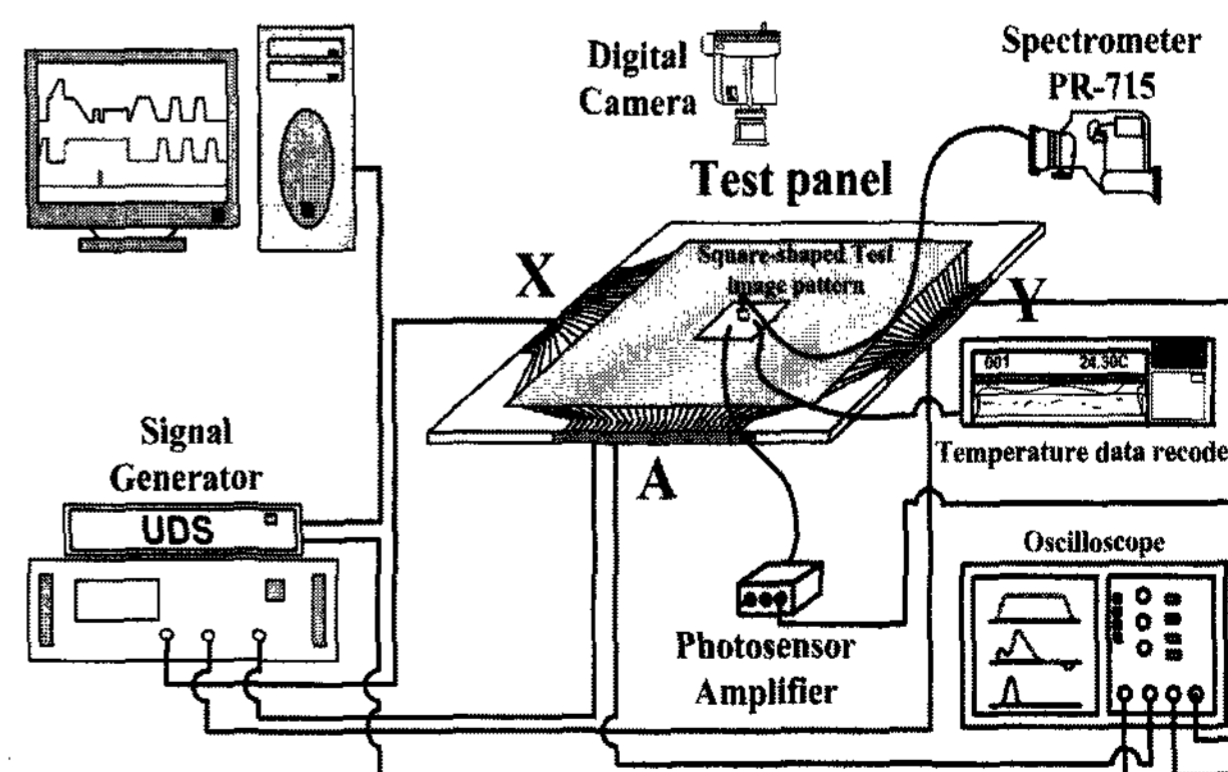

**Fig. 1.** Schematic diagram of experimental setup employed in this research.

Manuscript received August 11, 2007; accepted for publication September 15, 2007.

This work was supported by the Regional Innovation Center Program (ADMRC) of Ministry of Commerce, Industry and Energy of Korea.

\* Member, KIDS; \*\* Student Member, KIDS

Corresponding Author : Heung-Sik Tae

School of Electrical Engineering and Computer Science, Kyungpook National University, 1370 Sankyuk-Dong, Buk-Gu, Deagu 702-701, Korea.

E-mail : hstae@ee.knu.ac.kr Tel : 053-950-6563 Fax : 053-950-5505

UDS (Universal Driving System) were used to apply the driving waveform to the test panel. Temperature data recorder (DR230) was used to measure the real-time temperature of each test panel. To produce a residual image caused by image sticking, the entire measurement point of test panel was then abruptly changed to a dark background image after the 10-minute sustain discharge.

Figs. 2 (a) and (b) show the schematic diagrams of (a) the coplanar and (b) the face-to-face structures used in the current study. In both cases, the cell size such as the horizontal and vertical pitch was identical to the 42 in. full-HD grade PDP. Table 1 shows the comparison of cell specification between coplanar and face-to-face sustain electrode structure. In the coplanar structure, indium tin oxide (ITO) layers were used as the X and Y electrodes, whereas in the face-to-face structure, the silver (Ag) layers were used as the X and Y electrodes. The height and width of the barrier rib was 120  $\mu\text{m}$  and 70  $\mu\text{m}$ , respectively. The

**Table 1.** Comparison of specifications between coplanar and face-to-face sustain electrode structure.

	Coplanar structure	Face-to-Face structure
Gap of sustain electrode	70 $\mu\text{m}$	300 $\mu\text{m}$
Height of barrier rib	120 $\mu\text{m}$	
Width of barrier rib	70 $\mu\text{m}$	
Thickness of dielectric layer	40 $\mu\text{m}$	
Thickness of MgO layer	0.7 $\mu\text{m}$	
Cell pitch	480 $\mu\text{m}$ X 160 $\mu\text{m}$	
Gas chemistry	Ne – Xe (7%)	
Working gas pressure	450 Torr	

thickness of the dielectric layer was 40  $\mu\text{m}$ . An MgO protective layer with a thickness of 0.7  $\mu\text{m}$  was deposited on the dielectric layer. The distance between the discharge gaps were 300  $\mu\text{m}$  for the face-to-face sustain electrode structure and 70  $\mu\text{m}$  for the coplanar sustain electrode structure. The working gas and total gas pressure were Ne-Xe (7%) and 450 Torr, respectively.

Figs. 3 (a) and (b) show the driving waveforms suitable for (a) the coplanar sustain electrode structure and (b) the face-to-face sustain electrode structure. The driving waveforms applied to the coplanar sustain electrode structure were the conventional driving waveform, as shown in Fig. 3 (a). However, the conventional driving waveforms were not applicable to the face-to-face electrode structure due to the large sustain gap of 300  $\mu\text{m}$  and short distance between the address and sustain (X or Y) electrodes. Accordingly, the modified driving waveforms suitable for the face-to-face electrode structure were applied to the electrodes. During a reset-period, the ramp-bias pulse was applied to the address electrode, whereas the positive and negative square pulses were applied to the sustain and address electrode during a sustain-period as shown in Fig. 3 (b). The other driving conditions are given as follows: sustain frequency of 200 kHz, duty ratio of 50%, and 50 sustain pulses. In addition, to facilitate the sustain discharge for the face-to-face electrode structure, the address bias pulses with the amplitude of 40 and -40 V with the width of 0.5  $\mu\text{s}$  were applied.

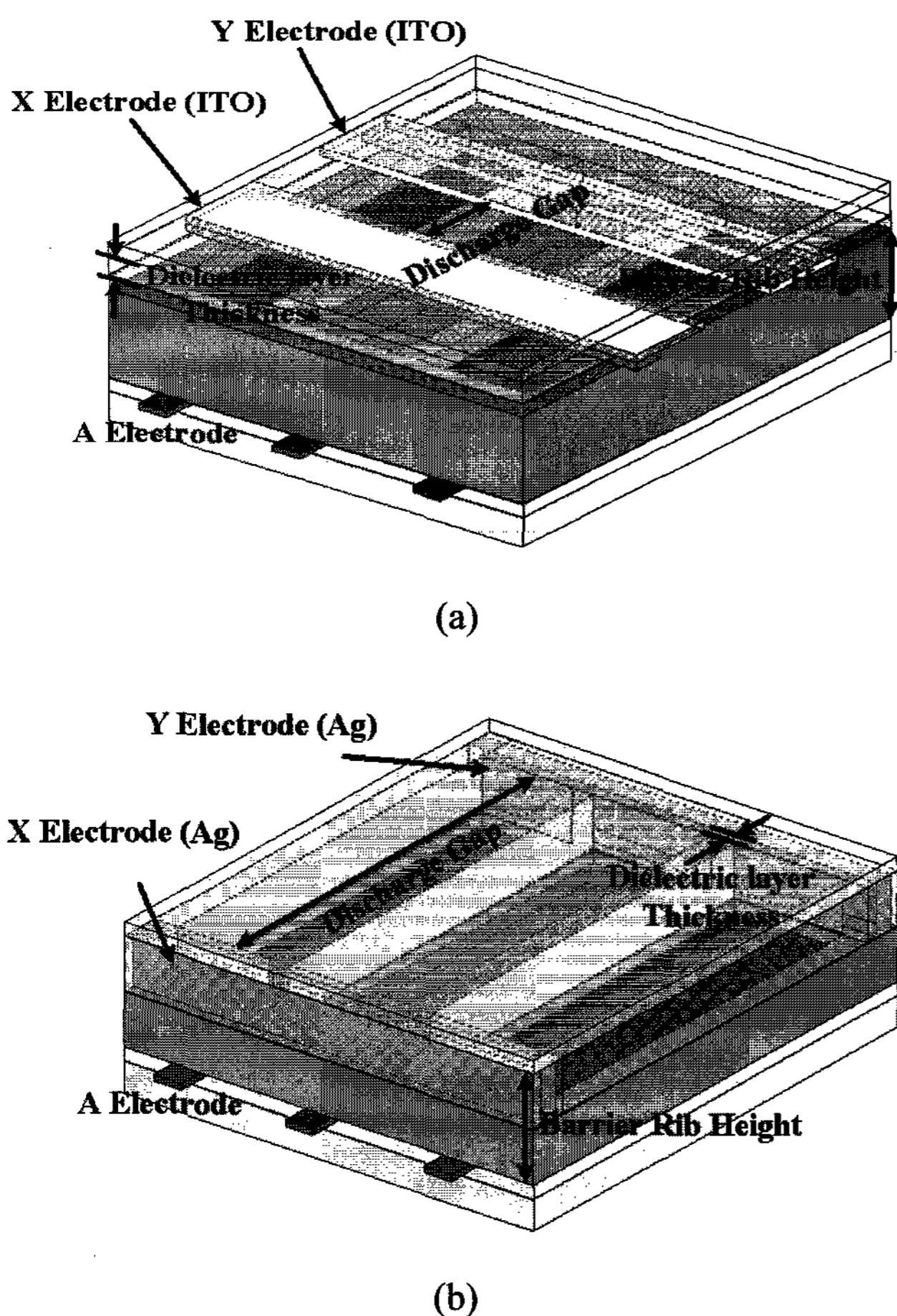

**Fig. 2.** Schematic diagram of (a) coplanar structure and (b) face to face structure employed in this study.

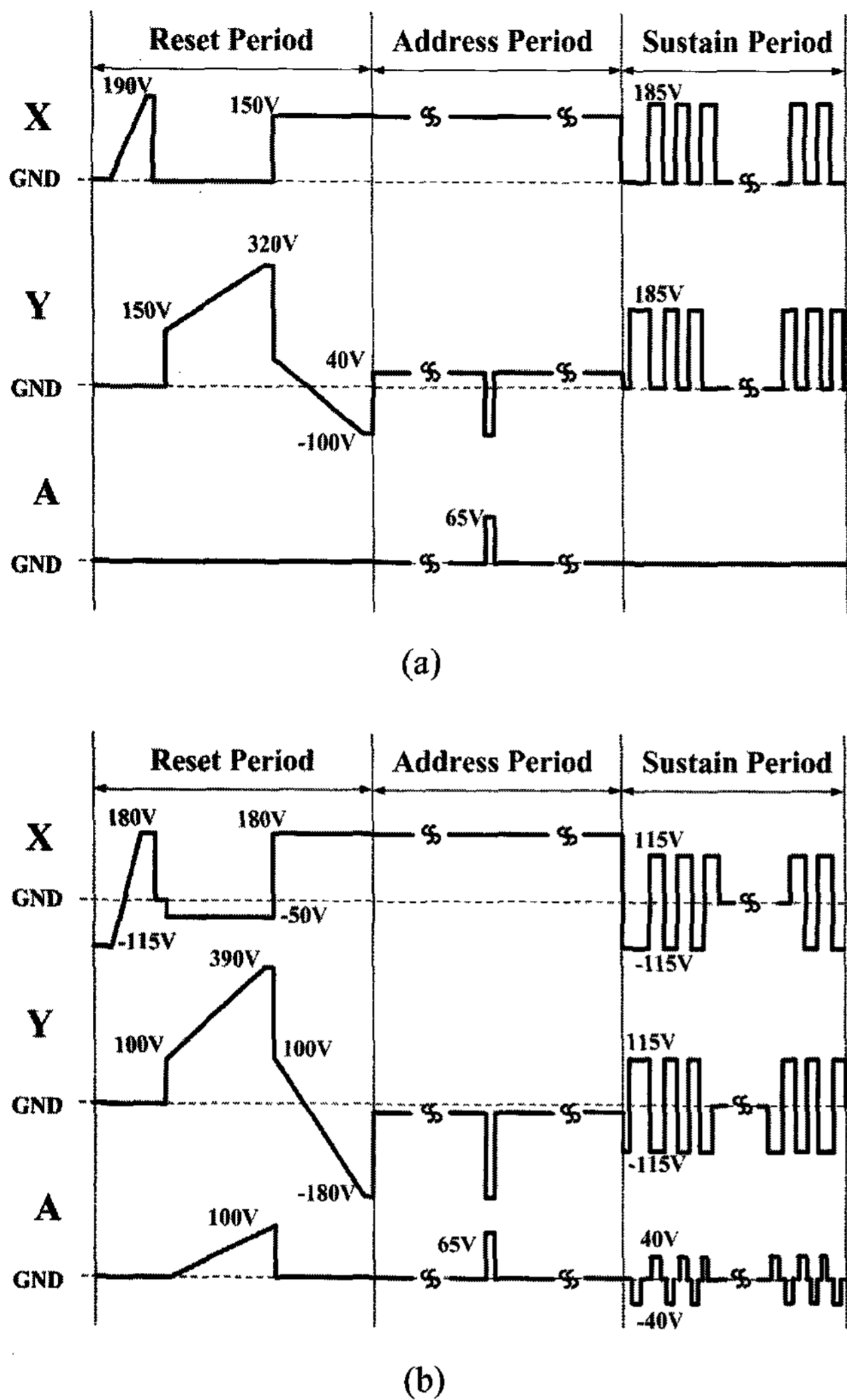
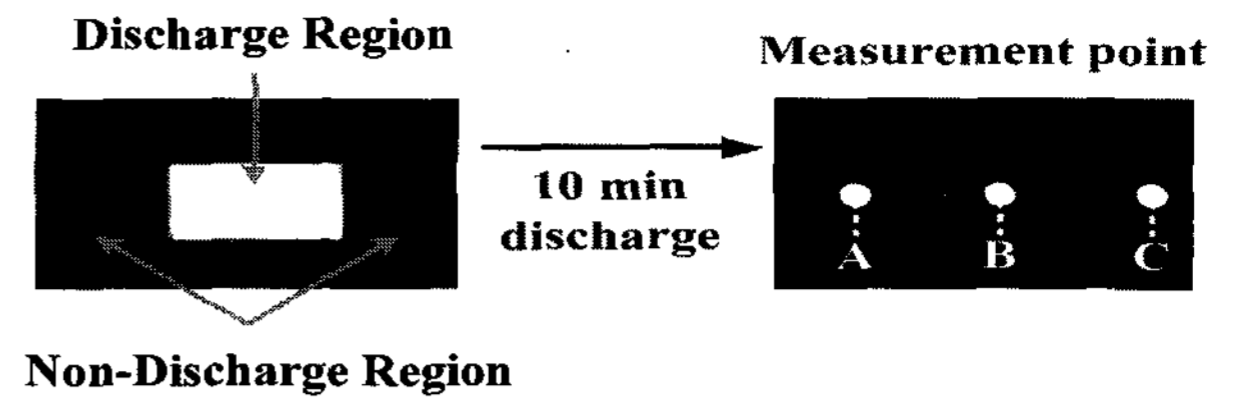

Fig. 3. Driving waveforms for (a) conventional coplanar sustain electrode and (b) face-to-face sustain electrode structure.

### 3. Results and discussion

Fig. 4 (a) shows the square-type test image pattern (region B: discharge region) for producing the temporal dark image with three measurement points, A, B, and C (regions A and C: non-discharge region). Figs. 4 (b) and (c) show the difference in the luminance among the three measurement points A, B, and C under the dark background image after the test image pattern was displayed for 10 minutes. In the coplanar electrode structure, the luminance difference at point B between the cases before and after 10-minute of sustaining discharge was increased by about 0.11  $\text{cd/m}^2$  (9.80 % up). On the other hand, in the case of the face-to-face structure, the luminance at point B before and after the 10-minute discharge increases by about 0.04  $\text{cd/m}^2$



(a)

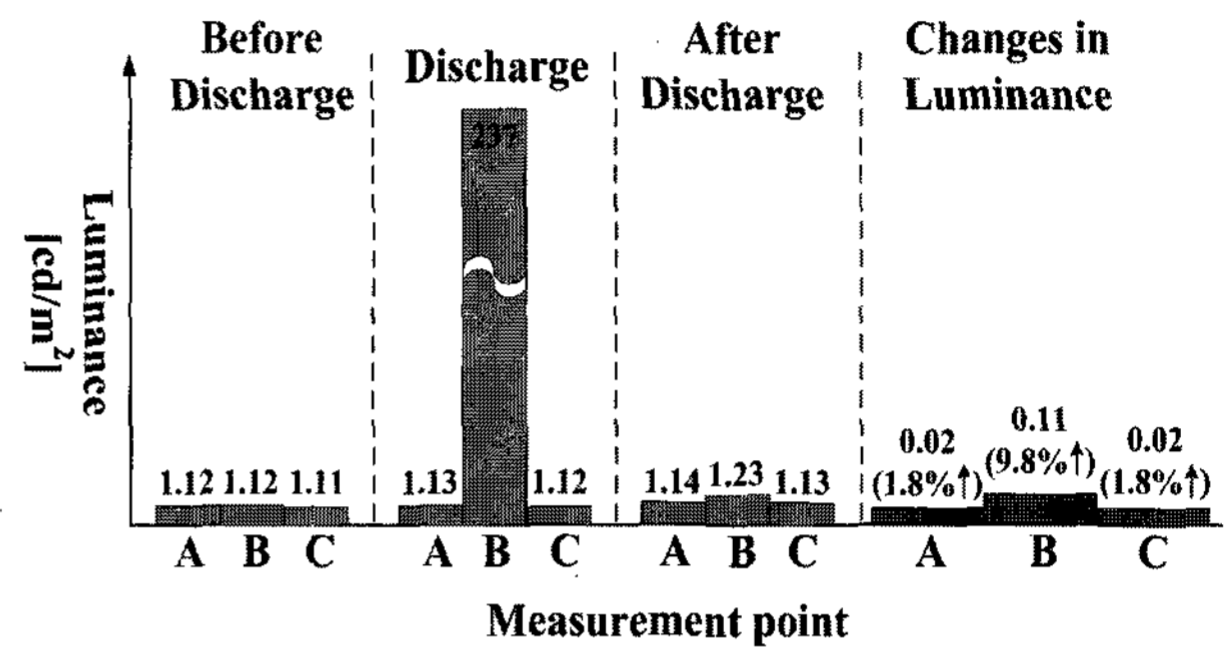

(b)

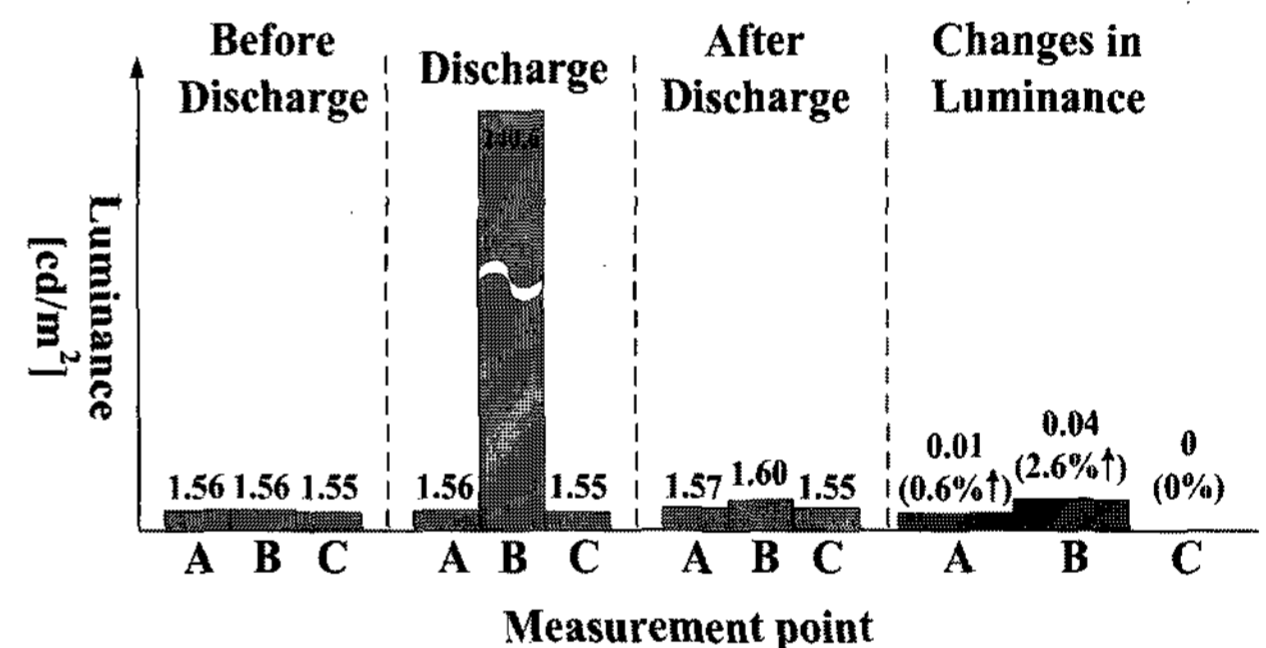

(c)

Fig. 4. (a) Square-shaped test image pattern and measurement point for investigating temporal dark image sticking, and changes in luminance for (b) coplanar and (c) face-to-face structure.

(2.6 % up). In this case, the decrease in the luminance difference means the alleviation of the temporal dark image sticking phenomenon. The temporal dark image sticking can be measured in terms of the luminance difference between the image sticking and no image sticking cells. However, when dealing with dark image sticking, the luminance perceived by human eyes should be considered instead of the measured display luminance, because the final estimation for dark image sticking is made by human eyes. The relation between the perceived luminance,  $P$  and the display luminance,  $L$  [ $\text{cd/m}^2$ ] is as follows [3, 5, 6].

**Table 2.** Difference in perceived luminance ( $=\Delta P$ ) measured at point B for both cases, where  $\Delta L$  is display luminance difference, and  $\Delta P$  is perceived luminance difference.

	$L_1$ [cd/m <sup>2</sup> ] Before discharge	$L_2$ [cd/m <sup>2</sup> ] After discharge	$\Delta L$ [ $= L_2-L_1 $ ]	$\Delta P$	
				Standard ( $\Delta P_s$ )	Dark ( $\Delta P_d$ )
Coplanar structure	1.12	1.23	0.11	$\Delta P_s=0.0871$	$\Delta P_d=0.3291$
				$\Delta P_s=0.0264$	$\Delta P_d=0.0918$
Face to face structure	1.56	1.60	0.04	$\Delta P_s=0.0264$	$\Delta P_d=0.0918$
				$\Delta P_s=0.0264$	$\Delta P_d=0.0918$

$$P = \begin{cases} 2.29 L^{0.382} & \text{for standard state} \\ 10 L^{0.333} & \text{for dark state} \end{cases}$$

Consequently, in the case of the coplanar sustain electrode structure in the image sticking cell (point B), the perceived luminance difference,  $\Delta P_s$  ( $= P_2 - P_1$ ) for the standard state was 0.0871. In contrast, for the dark case, the perceived luminance difference,  $\Delta P_d$  ( $= P_2 - P_1$ ) was 0.3291. In the case of face-to-face sustain electrode structure in image sticking cell (point B), the perceived luminance difference,  $\Delta P_s$  ( $= P_2 - P_1$ ) for the standard state was 0.0264 and 0.0918 for the dark state the dark state as shown in Table 2. Therefore, the perceived luminance variation of face-to-face structure was also lower than that of the coplanar structure.

Fig. 5 shows the changes in the IR (828 nm) emission measured at the point B during a reset-period under dark background condition. In both cases, the IR emission intensity increased slightly and the IR emission waveform was shifted to the left direction after 10 min. of -sustain discharge. The IR waveform was shifted to the left by 16.8  $\mu s$  for coplanar structure and 4.2  $\mu s$  for face-to-face structure. This phenomenon can be explained as follows: The IR emission from the image sticking cells was shifted to the left, meaning that the firing voltage was reduced in the image sticking cells due to the strong sustain discharge for a period of 10-min. Consequently, the fact that the face-to-face structure showed a smaller shift of IR ignition than that of the coplanar case implies the temporal dark image sticking was mitigated in the case of the face-to-face structure. To investigate the relation between the mitigation of temporal dark image sticking and the temperature rise induced by the 10 min. of sustain discharge, the temperature data recorder (DR230) was used to measure the panel-temperature difference.

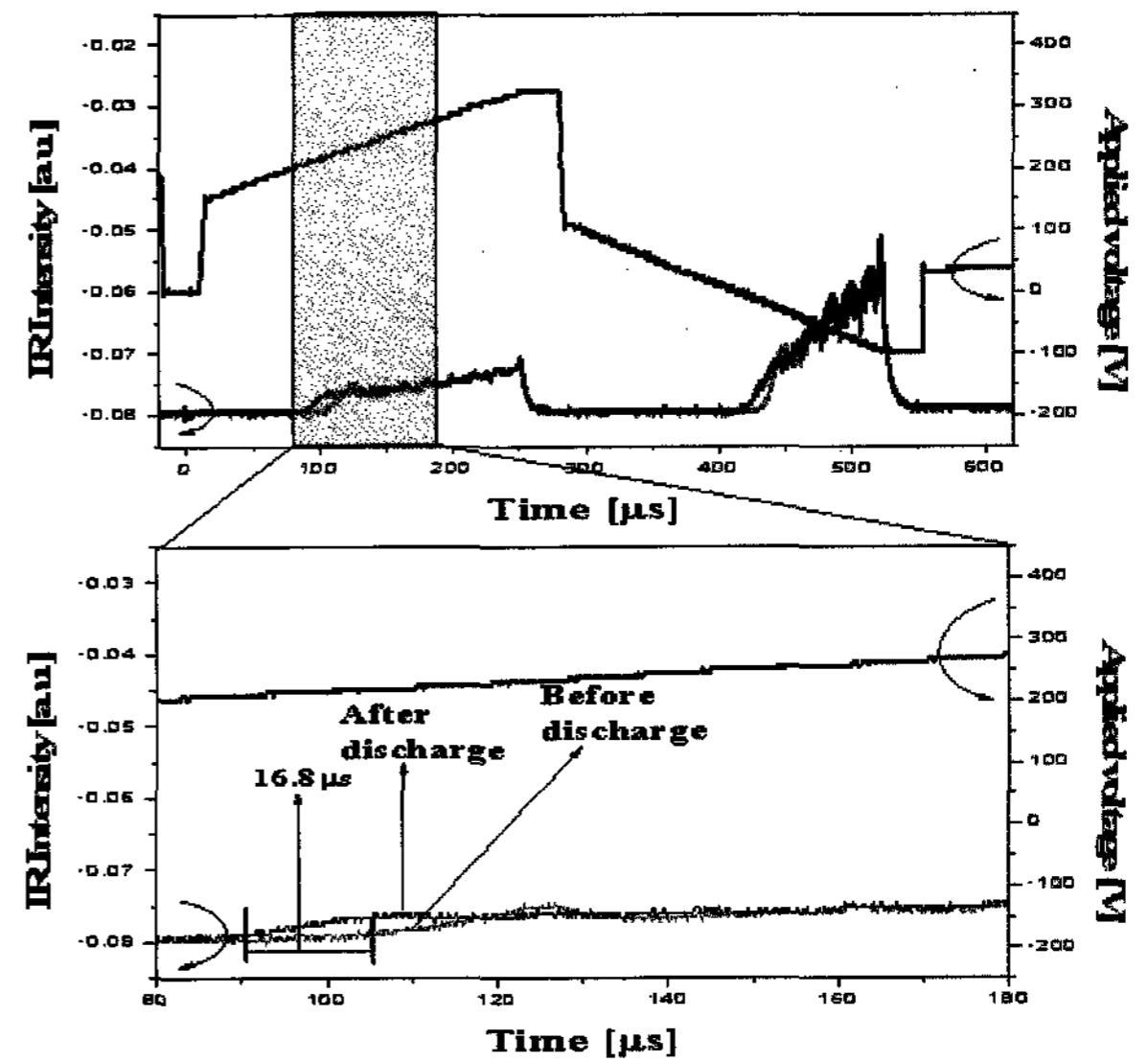

(a)

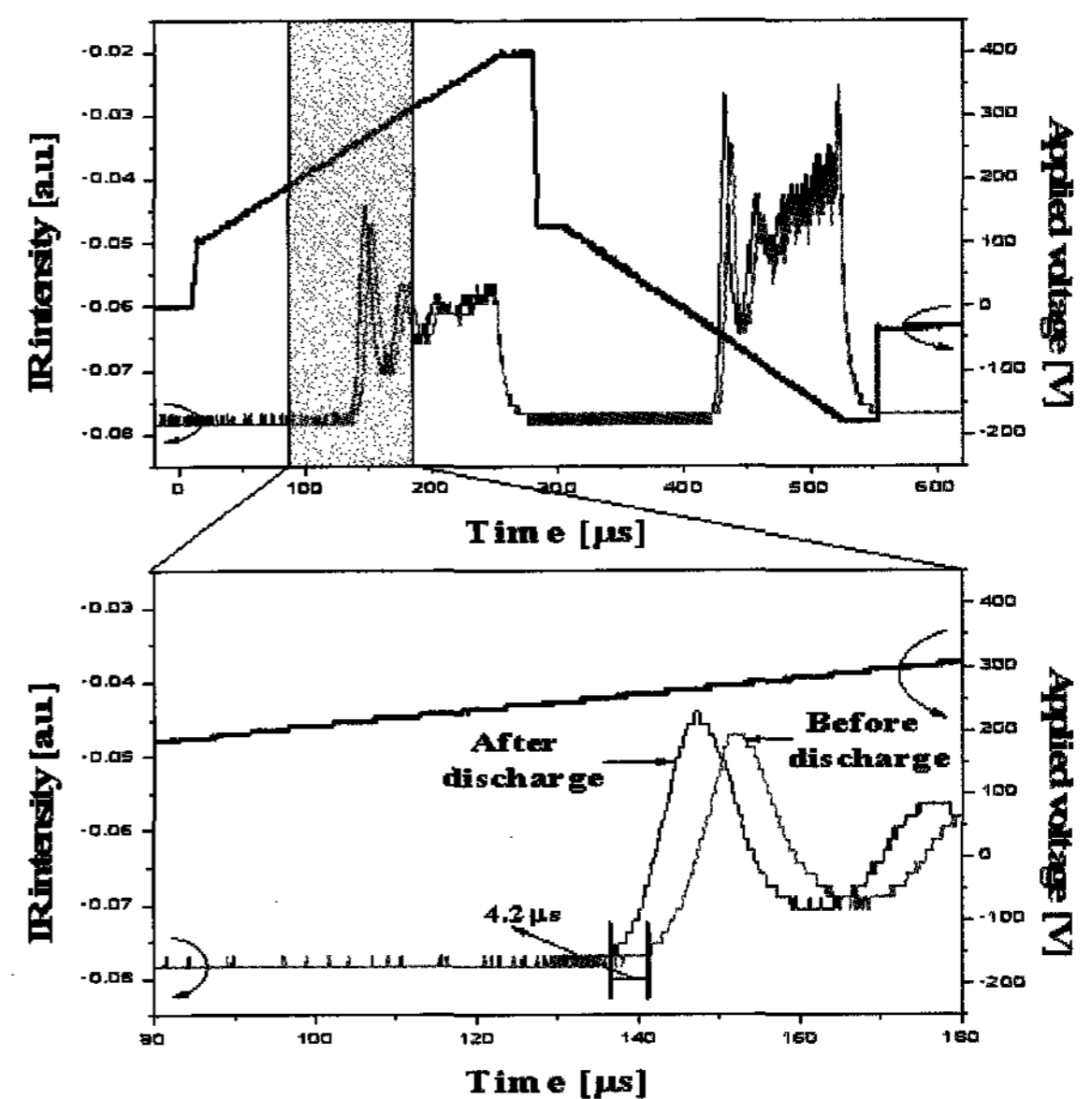

(b)

**Fig. 5.** Changes in IR (828 nm) emissions measured at point B during reset-period under dark background for both cases: (a) coplanar and (b) face-to-face structures.

Fig. 6 shows the changes in the panel temperature measured at point B for both structures before and after the 10 minute-sustain discharge. In both cases, the panel temperature increase on the front glass was caused by the iterant strong sustain discharge within cell. In coplanar structure case, the temperature increased by 15.4  $^{\circ}C$ , whereas in the face-to-face structure, the temperature increased by 10.5  $^{\circ}C$ . The origin of the smaller temperature

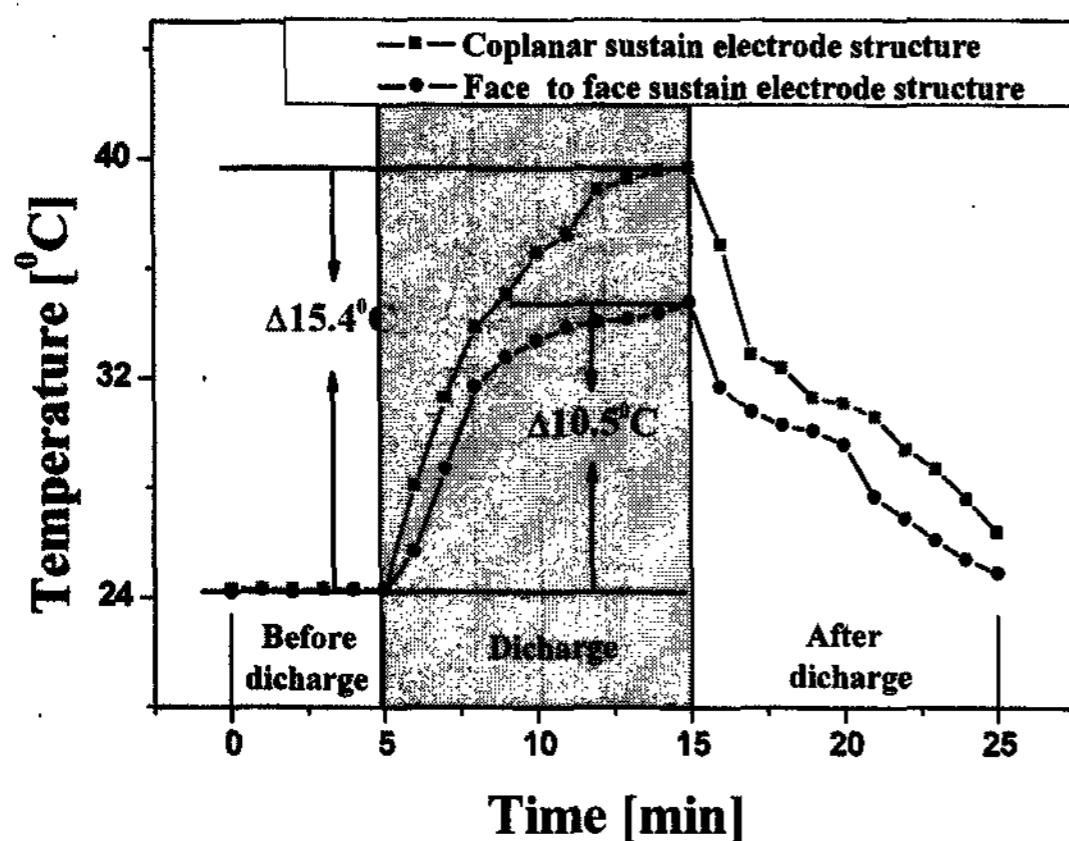

Fig. 6. Changes in panel temperature measured during 10 min-sustain discharge for both structures.

rise in the face-to-face case than that in the coplanar case can be attributed to the existence of ITO layer in the cell. The face-to-face structure is ITO-less structure, so that the temperature increase by the high resistivity of the ITO layer can be eliminated. Therefore, the temporal dark image sticking phenomenon is alleviated by the face-to-face electrode structure.

#### 4. Conclusion

The temporal dark image sticking phenomena in the face-to-face and coplanar sustain electrode structures were

compared. For both structures, the temporal dark image sticking phenomena were examined by measuring the difference in the IR emission profile, display luminance, perceived luminance, and temperature between the image sticking cell and the no image sticking cell. In the case of the face-to-face structure, 10 min. of sustaining discharge period induced a slight increase in the panel temperature, which is attributed to the ITO-less electrode structure. This mitigated the temporal dark image sticking.

#### References

- [ 1 ] H.-S. Tae, J.-W. Han, S.-H. Jang, B.-N. Kim, B. J. Shin, B.-G. Cho, and S.-I. Chien, *IEEE Trans. Plasma Science*. 32, 2189 (2004).
- [ 2 ] C.-S. Park, H.-S. Tae, Y.-K. Kwon, and E. G. Heo, *IEEE Trans. Electron Devices*. 54, 1315 (2007).
- [ 3 ] H.-S. Tae, C.-S. Park, B.-G. Cho, J.-W. Han, B. J. Shin, S.-I. Chien, and D. H. Lee, *IEEE Trans. Plasma Science*. 34, 996 (2006).
- [ 4 ] B.-S. Kim, H.-S. Tae, T. S. Cho, Y. D. Choi, J. N. Kim, K. S. Lee, Y. Terao, T. Miyama, and Y. Yamada, in *Proc. SID' 07 Dig.* (2007), p. 542.
- [ 5 ] J. C. Stevens and S. S. Stevens, *Journal of the Optical Society of America*. 53, 375 (1963).
- [ 6 ] M. Yamada, M. Ishii, T. Shiga, and S. Mikoshiba, in *Proc. SID' 02 Dig.* (2002), p. 940.