

# Co-Channel Interference Cancellation in Cellular OFDM Networks

## PART I : Maximum-Likelihood Co-Channel Interference Cancellation with Power Control for Cellular OFDM Networks

Manar Mohaisen\* *Regular Member*, KyungHi Chang\* *Lifelong Member*

### ABSTRACT

In cellular orthogonal frequency division multiplexing (OFDM) networks, co-channel interference (CCI) leads to severe degradation in the BER performance. To solve this problem, maximum-likelihood estimation (MLE) CCI cancellation scheme has been proposed in the literature. MLE CCI cancellation scheme generates weighted replicas of the transmitted signals where weights represent the estimated channel transfer functions. The replica with the smallest Euclidean distance from the received signal is selected and data are detected. When the received power of the desired and interference signals are nearly the same, the BER performance is degraded. In this paper, we propose a closed-loop power control (PC) scheme capable of detecting the equal received power situation at the mobile station (MS) receiver by using the newly introduced parameter power ratio (PR). When this situation is detected, the MS sends a feedback to the desired base station (BS) which boosts the transmission power in the next frame. At cell edge where signal to interferer ratio (SIR) is considered to have average value between -5 dB and 10 dB, computer simulations show that the proposed CCI cancellation scheme has a gain of 7 dB at 28 Km/h.

**Key Words :** Cellular OFDM, Maximum-Likelihood Co-channel Interference Cancellation, Closed-loop PC

### I. Introduction

Fourth generation mobile system services require high data rates and high-quality connections. Among a number of technologies, orthogonal frequency division multiplexing (OFDM) seems to be an attractive technology to meet the new mobile networks requirements [1]. When OFDM is applied to cellular communication systems, frequency reuse is required to increase the system capacity and to ameliorate the frequency utilization of the system. On the other hand, frequency reuse in cellular systems causes co-channel interference (CCI) which is one of the major factors that limit the capacity of the system [2].

In order to reduce the effect of CCI in OFDM networks, CCI cancellers based on maximum

likelihood estimation (MLE) have been proposed in [3] and [4]. The MLE scheme generates replica signals for desired and CCI signals from all possible weighted combinations of the desired and CCI signals. The weights represent the estimated channel transfer functions at the sub-carriers. The replica that has the smallest Euclidean distance from the received signal is selected, then data are detected [3]. When the received power of the desired and the interference signals is nearly the same, several signal combinations result in similar replicas that give the same Euclidean distance from the received signal. As consequence, the MLE cannot distinguish between signals, and the BER performance is degraded [4]. In this situation, even using frequency interleaving (FI) [5] with low-rate forward error correction code, no improvement is achieved.

\* 인하대학교 정보통신대학원 이동통신연구실 (khchang@inha.ac.kr)

논문번호 : KICS2007-03-115, 접수일자 : 2007년 3월 9일, 최종논문접수일자 : 2007년 5월 15일

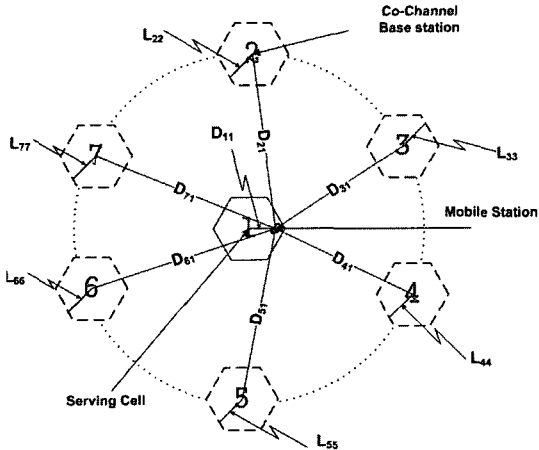

Fig 1. OFDM cellular network with CCI.

In this paper, we propose an improved MLE CCI cancellation by applying closed-loop power control (PC) scheme to combat against the situation where received power of desired and interference signals is nearly the same. The proposed closed-loop PC scheme highly reduces the degradation of BER performance caused by the CCI.

This paper is organized as follows: CCI effects on the performance degradation is presented in section 2 and the BER behavior of the MLE canceller is presented in section 3. In section 4, we describe the proposed closed-loop PC scheme by presenting the BS transmitter and MS receiver structures in detail.

Simulation results under various mobilities and channel environments are presented in section 5. Finally, we draw conclusions in section 6.

## II. CCI in Cellular OFDM Networks

### 2.1 Cellular OFDM Networks with CCI

When OFDM is applied to cellular networks, frequency reuse is used to increase the frequency utilization of the overall system. As shown in Fig. 1, by applying frequency reuse, different BSs geographically separated by a reuse distance use the same frequency. This leads to a mutual CCI between cells. CCI degrades the BER performance at mobile stations served by these cells and in severe situations it leads to a link failure between MS and serving BSs [6]. In Fig. 1,  $D_{k1}$  is the distance between the  $k$ -th BS

and the MS while  $L_{kk}$  is the distance between the  $k$ -th BS and the MS served by it. Furthermore, BS number 1 is considered as the serving BS.

In the following sub-section, the effect of CCI on the BER performance is studied and a BER general formula for QAM modulation is introduced.

### 2.2 Effect of the CCI on the BER Performance Degradation in Cellular OFDM Networks

The transmitted signal from the  $j$ -th BS represented by the inphase (I) and quadrature phase (Q) is given by  $x_j(t) = x_j^I(t) + x_j^Q(t)$  [7] where

$$y_j^I(t) = \sum_{i=0}^{N-1} \sum_{k=-\infty}^{\infty} \sqrt{2P}(L_{ji})^{\alpha/2} d_{ijk}^I h(t-kT) \cdot \cos(2\pi f_i t + \theta_j) \quad j = 1, 2, \dots, K+1 \quad (2-1)$$

$$y_j^Q(t) = \sum_{i=0}^{N-1} \sum_{k=-\infty}^{\infty} \sqrt{2P}(L_{ji})^{\alpha/2} d_{ijk}^Q h(t-kT) \cdot \sin(2\pi f_i t + \theta_j) \quad j = 1, 2, \dots, K+1 \quad (2-2)$$

Where  $i$  is the subcarrier index,  $j$  is the BS index,  $k$  is the time index,  $h(t)$  is the shaping function,  $\theta_j$  is the phase introduced in the  $j$ -th BS transmitter,  $L_{ji}$  is the distance between the  $j$ -th BS and the MS served by the  $j$ -th BS,  $\alpha$  is the propagation loss factor,  $K$  is the number of interferer BSs,  $P$  is the normalized power of the transmitted signal and  $d_{ijk}^I$  and  $d_{ijk}^Q$  are the inphase and quadrature phase components of the transmitted data symbol. In this section, the channel is considered to be slowly-varying frequency-selective channel for the purpose of obtaining a perfect automatic power control. Under the above assumption, the contribution of the  $j$ -th BS signal at the MS receiver,  $y_j(t)$ , is given by  $y_j(t) = y_j^I(t) + y_j^Q(t)$  where

$$y_j^I(t) = \sum_{i=0}^{N-1} \sum_{k=-\infty}^{\infty} A_{ij} \sqrt{2P}(L_{ji})^{\alpha/2} d_{ijk}^I h(t-kT-\tau_j) \cdot \cos(2\pi f_i(t-\tau_j) + \theta_{ij}) \quad j = 1, 2, \dots, K+1 \quad (2-3)$$

$$y_j^Q(t) = \sum_{i=0}^{N-1} \sum_{k=-\infty}^{\infty} A_{ij} \sqrt{2P}(L_{ji})^{\alpha/2} d_{ijk}^Q h(t-kT-\tau_j) \cdot \sin(2\pi f_i(t-\tau_j) + \theta_{ij}) \quad j = 1, 2, \dots, K+1 \quad (2-4)$$

$A_{ij}$ ,  $i = 0, 1, \dots, N-1$  and  $j = 1, 2, \dots, K+1$ , are iid random variables with Rayleigh distribution and have the same variance  $\sigma^2$ .  $\tau_j$  is uniformly distributed over the interval  $[0, T]$  and  $\theta_{ij}$  is uniformly distributed over  $[0, 2\pi]$ .

Consider the scenario depicted in Fig. 1, the received signal at the MS can be written as

$$r(t) = \sum_{j=1}^{K+1} y_j(t)(D_{j1})^{-\alpha/2} + n_j(t) \quad (2-5)$$

where  $D_{j1}$  is the distance between the  $j$ -th BS and the MS served by BS number 1 which is considered to be the desired BS and  $n(t)$  is the AWGN with two-sided spectral density of  $N_0/2$ . Now, consider that the phase of the received signal arriving from the desired BS can be estimated so as coherent receiver can be applied. So, the output of the two branches of the correlator at subcarrier  $m$  is given by

$$r_m^I = \int_0^T r(t) \cos(2\pi f_m t) dt = S^I + I^I + N^I \quad (2-6)$$

$$r_m^Q = \int_0^T r(t) \sin(2\pi f_m t) dt = S^Q + I^Q + N^Q \quad (2-7)$$

where  $S$ ,  $I$  and  $N$  are the desired BS, CCI and AWGN signals, respectively. The power contribution of the desired BS, CCI and AWGN for the inphase branch and BPSK modulation can be described as follows

$$(S^I)^2 = T \frac{P}{2} (A_{mj})^2 \quad (2-8)$$

Note that  $A_{mj}$  are iid, so  $E[A_{mj}A_{mi}] = 0$  for  $j \neq i$ . Assume that  $E[A_{mj}^2]$  to be unity  $\forall j$  then

$$E[(I^I)^2] = \frac{PT}{4} \sum_{j=2}^{K+1} \left( \frac{L_{jj}}{D_{j1}} \right)^\alpha \quad (2-9)$$

and the AWGN has a two-sided spectral density of  $N_0/2$ . Consider that a perfect power control is applied and an equal mutual CCI between the BSs. Furthermore, consider that omni-directional antennas are used. Then,  $\sum_{j=2}^{K+1} \left( \frac{L_{jj}}{D_{j1}} \right)^\alpha = \sum_{j=2}^{K+1} \left( \frac{1}{SIR_j} \right)$ ,  $E_b/N_0 = PT/N_0$ , and the signal to interference and noise ratio at the  $m$ -th sub-carrier ( $SINR_m$ ) is given by

$$SINR_m = \sqrt{\frac{1}{\frac{E_b/N_0}{2\gamma_b} \left[ \sum_{j=2}^{K+1} \frac{1}{SIR_j} + \frac{2}{E_b/N_0} \right]}} \quad (2-10)$$

Table 1. Simulation parameters.

Parameter	Value
Carrier Frequency	2 GHz
Number of Cells	2
Bandwidth	10 MHz
FFT Size	64
Guard Interval Length	16
Modulation	QPSK
Maximum Dopp. Freq.	150 Hz

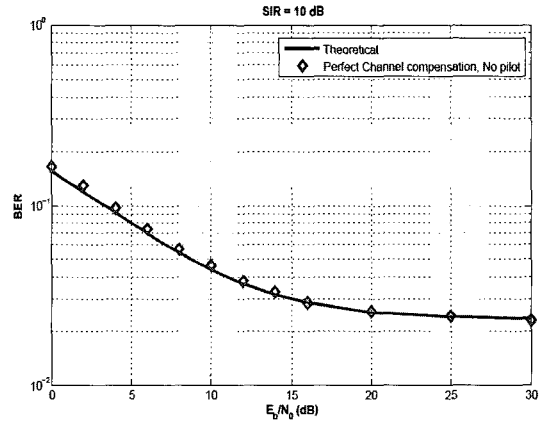

Fig 2. BER performance degradation in 2-cell OFDM networks; theoretical and simulation results.

where  $SIR$  states for signal to interferer ratio. For BPSK,  $P_{em}(\gamma_b) = Q(SINR_m(\gamma_b))$  where  $Q(u) = \frac{1}{\sqrt{2\pi}} \int_u^\infty \exp(-z^2/2) dz$ . To get the non-conditional probability of error,  $P_{em}(\gamma_b)$  is averaged over the Chi distribution of  $\gamma_b$ .

Finally, the BER for BPSK modulation is given by

$$P_e = \frac{1}{2} \left[ 1 - \frac{1}{\sqrt{\sum_{j=2}^{K+1} \frac{1}{SIR_j} + \frac{1}{E_b/N_0} + 1}} \right] \quad (2-11)$$

and for QAM modulation, the BER in existence of CCI is given by

$$P_e = \frac{1}{\log_2(\sqrt{M})} \left( 1 - \frac{1}{\sqrt{M}} \right) \left[ 1 - \frac{1}{\sqrt{\frac{M-1}{3} \left[ \sum_{j=2}^{K+1} \frac{1}{SIR_j} + \frac{2}{(\log_2 M) E_b/N_0} \right] + 1}} \right] \quad (2-12)$$

To verify the derived BER performance formulas, a 2-cell cellular OFDM system is simulated using the parameters of Table 1. The channel is perfectly compensated in the time domain by compensating for the rotation while the fluctuations in the channel amplitude is not compensated. For this simulation, a pilot signal is not needed for the channel estimation. As shown in Fig. 2, the simulation results matches the theoretical curve obtained using the derived formula. In the simulation result, there was only a 0.97-dB of shift from the theoretical values. The shift is due to the cutting off of the guard interval power from the received signal before the FFT.

### III. BER Behavior of MLE CCI Canceller

When the received power of the desired and interference signals is nearly the same (i.e. SIR = 0 dB), the BER performance is degraded, because there are several combinations that result in the same replicas. This leads to ambiguity at the MS receiver because several replicas have the same minimum Euclidean distance from the received signal.

Fig. 3 (a) and (b) show an example of the BER performance of the MLE canceller and the probability of sub-carriers having SIR = 0 dB where a single CCI BS is considered, respectively. The BER performance is degraded when the probability of sub-carriers having 0dB increases. In practice, measuring the instantaneous SIR value in cellular OFDM system is nearly impossible. This is why we introduce the new term PR. For two-cell scenario, PR is given by

$$PR = 10 \log_{10} \left( \frac{\sum_{i=1}^N \hat{h}_{1i}^2}{\sum_{i=1}^N \hat{h}_{2i}^2} \right) \quad (3-1)$$

where  $\hat{h}_{1i}$  and  $\hat{h}_{2i}$  are the estimated channel

coefficients between the MS and the desired and interferer BSs, respectively, at  $i$ -th subcarrier. Fig 3 (c) shows the PR values versus frame index. As it is clear from this figure, the PR is inversely proportional to the probability of sub-carriers having SIR = 0 dB; when the PR value decreases under certain threshold, the probability of sub-carriers having SIR = 0 dB increases and consequently the BER performance is degraded.

Therefore, the PR can be used to indicate the probability of sub-carriers having SIR = 0 dB.

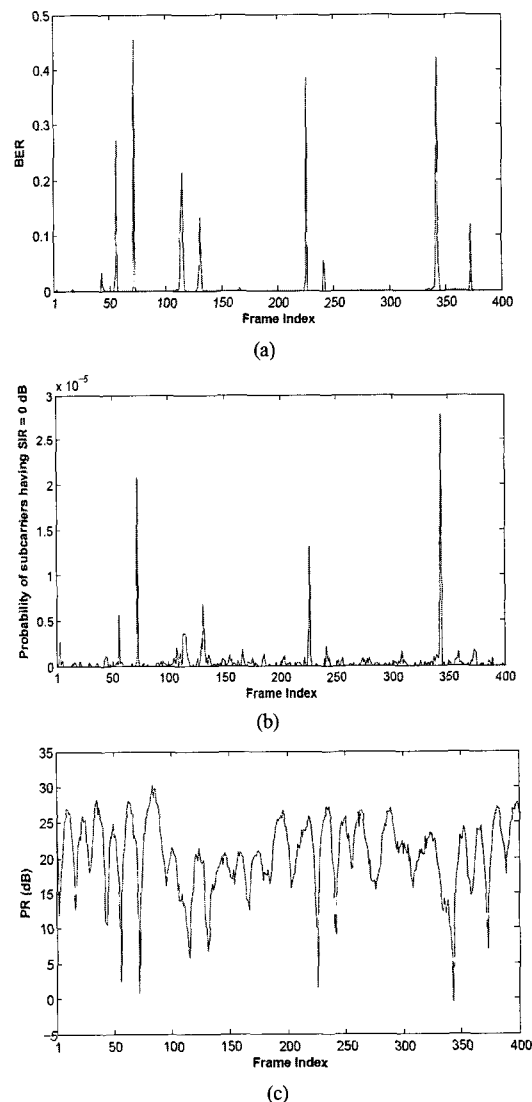

Fig 3. (a) BER of CCI canceller without PC vs. frame index. (b) Probability of sub-carriers having SIR = 0 dB vs. frame index. (c) PR vs. frame index.

In the next section the closed-loop PC is explained in more detail.

#### IV. MLE CCI Canceller with PC

Fig. 4 shows the BS transmitter structure; after frame construction, data are serial to parallel converted to N parallel bit streams. Each bit stream is modulated using QPSK modulator.

If the MS feedback is 1, the power control unit boosts the transmission power of next frame by 3 dB otherwise transmission power is not boosted. The

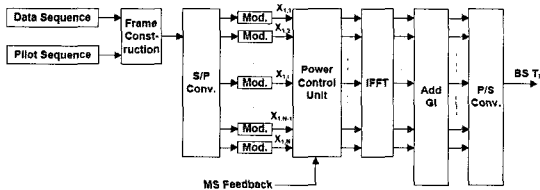

Fig 4. Desired BS transmitter structure.

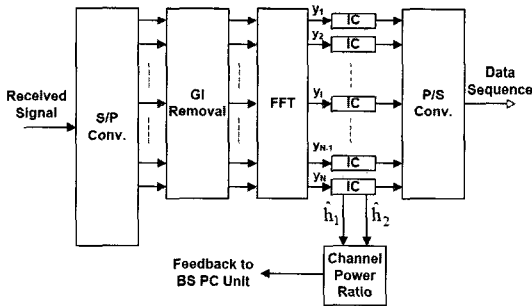

Fig 5. MS receiver structure.

output of the power control unit is fed to IFFT to get the time domain signal. Finally, the guard interval (GI) is added and data are parallel to serial converted and then transmitted.

Fig. 5 shows the MS receiver structure. At first, received signal is serial to parallel converted then the GI is removed. The FFT is applied to get the frequency domain signal Y.

The received signal on the l-th subcarrier is given by

$$y_l = \sum_{k=1}^{K+1} h_{k,l} x_{k,l} + n_l \quad (4-1)$$

where  $x_{k,l}$  is the symbol transmitted on the l-th

subcarrier by the k-th transmitter and  $n_l$  is the AWGN at the l-th subcarrier.

Fig. 6 shows the CCI Canceller (IC) for  $K = 1$  at the l-th sub-carrier, the MLE block outputs a set of desired and CCI candidates which are modulated and

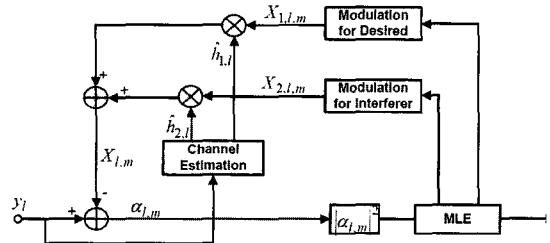

Fig 6. CCI canceller.

weighted using the estimated channel transfer function and added to generate the replica which is indexed by m. Each generated replica is compared with the received signal on the l-th subcarrier. The resulting Euclidean distance between the replica m and the received signal  $y_l$  is given by

$$\alpha_{l,m} = y_l - \sum_{k=1}^2 \hat{h}_{k,l} x_{k,l,m} \quad (4-2)$$

The MLE block chooses the candidate of the desired and CCI which has the least  $|\alpha_{l,m}|^2$ . The estimated transfer functions of the desired and CCI BSs ( $\hat{h}_1$  and  $\hat{h}_2$ ) are fed to the channel PR unit which calculates the PR value and compares it with a fixed threshold dependent on the MS speed and average SIR value. If the PR is less than the threshold, the MS sends a feedback to the desired BS's PCU to boost the transmission power for the next frame.

#### V. Simulations Results

Computer simulations were performed to examine the performance of the MLE with and without PC to show the gain of the proposed algorithm.

Table 2 shows the main parameters used for these simulations. The parameters were set to these values to have a fair comparison with the obtained results of the MLE CCI canceller proposed in [3]. The number

of CCI BSs  $K = 1$ . This means that a single CCI BS was considered. An OFDM frame has 4 pilot symbols used for channel estimation and 51 data symbols. The overall OFDM frame duration is  $220 \mu s$ . The desired BS pilots are inserted on the odd indexed sub-carriers of the odd indexed pilot OFDM symbols and on the even sub-carriers of the even indexed pilot OFDM

Table 2. Simulations parameters.

Parameter	Value
Carrier Frequency	2 GHz
Number of Cells	2
Bandwidth	20 MHz
FFT Size	64
Guard Interval Length	16
Modulation	QPSK
Mobility	10 & 28 Km/h

Table 3. Threshold values under different mobilities and SIR values.

SIR	Mobility	
	10 Km/h	28 Km/h
-20	-20	-20
-15	-15	-15
-10	-10	-7
-5	2	-4
0	2	0
5	5	5
10	10	10
15	12	15
20	14	18
25	17	20
30	20	22
35	22	24

symbols. While the CCI BS pilots are inserted on the even indexed sub-carriers of the odd indexed pilot OFDM symbols and on the odd indexed sub-carriers of the even indexed OFDM symbols. In the frequency domain, the channel transfer function is estimated by averaging over the four pilot symbols in the time domain.

When the PR decreases under certain threshold, the MS sends a feedback to the desired BS asking it to boost the power by 3 dB for the next frame to be transmitted. The threshold value is dependent on the average SIR value and on the MS speed. We assume that the MS can measure the average SIR and its speed which can be obtained from the maximum Doppler

shift. Table 3 shows optimized values of these thresholds at different mobilities.

Fig. 7 shows the BER performance of the MLE CCI cancellation scheme with and without the proposed closed-loop PC scheme under signal-path fading environment. In addition, the theoretical BER performance without any CCI cancellation is shown as dashed line.

MS speed and  $E_b/N_0$  are set to 10 Km/h and 18 dB, respectively. The proposed closed-loop PC scheme has a gain of about 7.5 dB for cell-edge users after compensating power loss used in the PC process. The cell edge users are considered to have an average SIR value between -5 dB and 10 dB.

Fig. 8 shows the BER performance of the MLE CCI cancellation algorithm with and without the proposed closed-loop PC scheme.

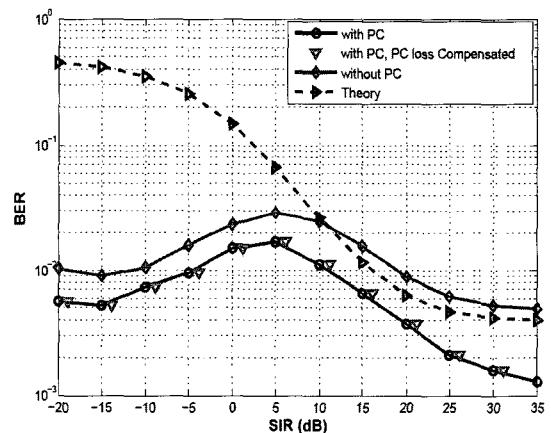

Fig. 7. BER performance under single-path fading channel,  $E_b/N_0 = 18$  dB and speed = 10 Km/h.

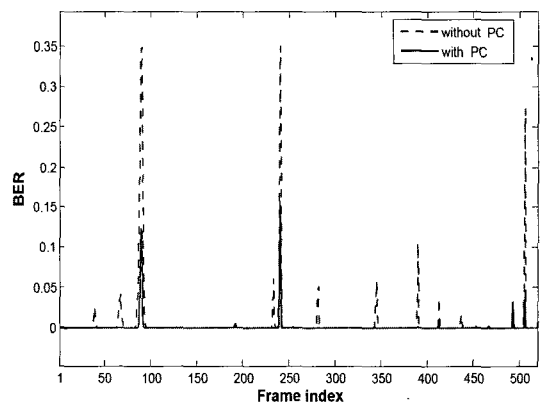

Fig. 8. BER performance improvement by PC.

The PR is used to detect the probability of sub-carriers having SIR = 0 dB. Where the biggest part of the BER occurs on sub-carriers having SIR of about 0 dB. The dashed line curve represents the BER of the MLE CCI cancellation scheme without PC while the solid line represents the BER with closed-loop PC scheme applied.

As shown, applying the closed-loop PC scheme leads to high decrease in the BER and some frames become error free.

Fig. 9 shows the BER performance of the proposed scheme at MS mobility of 28 Km/h. The gain of the proposed scheme at this speed is about 7 dB in SIR for users at the cell edge where SIR takes the range -5 and 10 dB.

From the analysis of the simulation results at different SIR values, we conclude that as the PR curve become smoother, the efficiency of the proposed scheme increases because of the slow change of the

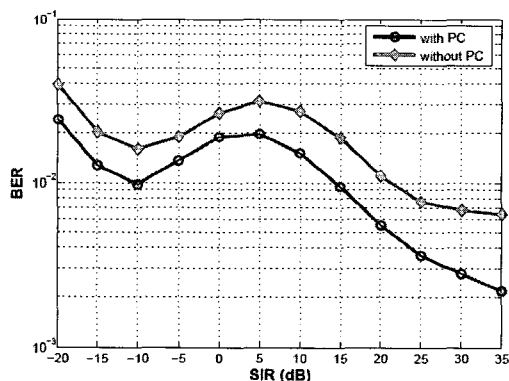

Fig. 9. BER performance under single-path fading channel,  $E_b/N_0 = 18$  dB and speed = 28 Km/h.

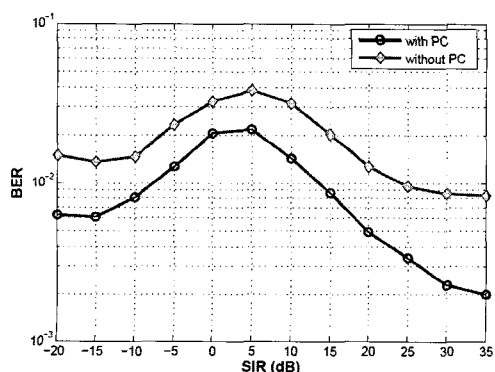

Fig. 10. BER performance under two-path fading channel,  $E_b/N_0 = 18$  dB and speed = 10 Km/h.

interference.

On the other hand, when the PR curve highly fluctuates, less gain is obtained but it is still significant and it is of the order of 1 dB of gain in  $E_b/N_0$ .

As one can see, the gain obtained at the mobilities 10 and 28 is the nearly the same. This indicates the robustness of the proposed scheme for working under different environments.

Fig. 10 shows the BER performance of the proposed scheme under two-path fading channel. The delay between the two paths is six samples. For users at the cell-edge, which are the target of any CCI cancellation scheme, the gain is about 7 dB.

## VI. Conclusions

To reduce the degradation in the BER performance in cellular OFDM networks, MLE CCI canceller has been proposed in the literature. When the received power of the desired and CCI signals is nearly the same, different replicas result in minimum Euclidean distance from the received signal and therefore the BER performance of the MLE CCI canceller is degraded. In this paper, we propose a closed-loop PC scheme capable of detecting the situation where equal power from desired and CCI BSs is received. To detect this situation, we introduced the new PR term which represents the ratio between the average estimated channels powers of the desired and CCI BSs.

Computer simulations were performed to investigate the performance improvement of the proposed MLE CCI cancellation with closed-loop PC scheme. The closed-loop PC gain was calculated for the users at cell-edge where average SIR is considered to have values between -5 and 10 dB. At mobility of 10 to 30 Km/h, the gain of the proposed closed-loop PC scheme about 6.5 dB under single-path and 2-path fading channels. These results show that the proposed closed-loop PC scheme shows excellent BER performance improvement and this highly increases the cellular OFDM system capacity.

## References

- [1] S. Hara and R. Prasad, *Multicarrier Techniques*

for 4G Mobile Communications. Boston, MA: Artech, 2003.

- [2] G. L. Stuber, *Principles of Mobile Communications*. Georgia, Atlanta: Kluwer, 2001.
- [3] H. Yoshino and A. Czylik, "Adaptive co-channel interference (CCI) cancellation for OFDM communication systems," in *Proc. Intern. Zurich Seminar on Broadband Commun.*, Feb 2000, pp.245-250.
- [4] M. Shibahara, T. Fujii, I. Sasase and T. Saba, "Performance evaluation of adaptive co-channel interference canceling receiver using frequency spread coding and frequency interleaving for OFDM systems," *European Transactions on Telecommunications*, vol. 14, no. 1, pp.15-24, March 2003.
- [5] SPW Jarot and M. Nakagawa, "Evaluation of frequency interleaving effects in convolutional coded OFDM systems for broadband mobile communication," in *Proceedings of the IEEE International Conference on Telecommun.*, June 2001, pp. 443-448.
- [6] D. P. Agrawal and Qing-An Zeng, *Introduction to Wireless and Mobile Systems*. Thomson, 2003.
- [7] Chi-Hsiao Yih and Evaggelos Geraniotis, "Analysis of co-channel interference in multi-cell OFDM networks," in *Proc. Intern. Symp. on Personal, Indoor and Mobile Radio Commun.*, Sep 1998, pp. 544-548.

### Manar Mohaisen

Regular Member



July, 2001: BS, Communication and Control, Univ. of Gaza, Gaza, Palestine

Sep., 2005: MS, The School Polytechnic of Nice Univ., Sophia-Antipolis, France

Feb., 2006 ~ Present: Ph.D. student, The Graduate School of IT & T, INHA University

2001~2003: The Palestinian Telecommunication Company (JAWWAL)

<Research Interests> MIMO Detection and Co-Channel Interference Cancellation

### KyungHi Chang

Lifelong Member

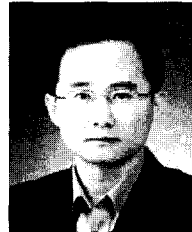

Feb., 1985: BS, Electronics Engineering, Yonsei University

Feb., 1987: MS, Electronics Engineering, Yonsei University

Aug., 1992: Ph.D., EE Dept., Texas A&M University

1989 ~ 1990: A Member of Research Staff, Samsung Advanced Institute of Technology (SAIT)

1992 ~ 2003: A Principal Member of Technical Staff (Team Leader), Electronics and Telecommunications Research Institute (ETRI)

2003 ~ Present: Associate Professor, The Graduate School of IT & T, INHA University

<Research Interests> RTT design for IMT-Advanced & 3GPP LTE Systems, WMAN System Design, Cognitive Radio, Cross-layer Design, and Cooperative Relaying System