

## BLDC Motor Control Algorithm for Industrial Applications Using a General Purpose Processor

Nam-Hun Kim<sup>†</sup>, Oh Yang<sup>\*</sup> and Min-Huei Kim<sup>\*\*</sup>

<sup>†</sup>School of Electronics and Information Engineering, Cheongju University, Korea

<sup>\*\*</sup>Dept. of Automatic Electrical Engineering, Yeungnam College of Science and Technology, Korea

### ABSTRACT

Electrical motors are an integral part of industrial plants with no less than 5 billion motors built world wide every year. The demand for low-cost brushless DC (BLDC) motors has increased in industrial applications. This paper presents a BLDC motor control algorithm for low-cost motor drive applications using general purpose microcontrollers which have only one on-chip timer. This paper describes how to realize pulse width modulation (PWM) signals with general input/output (I/O) ports to control a three-phase permanent magnet brushless DC motor using the timer interrupt on MSP430F1232.

**Keywords:** BLDC motor, PWM, industrial application, MSP430F1232

### 1. Introduction

Low end applications of motor control can be found in diverse lines of consumer, medical, and industrial products. High efficiency variable speed and variable torque motor control is only possible using electronic components and microcontrollers. Low cost is still a dominant factor in designing very low-end products using motor control. Hand-held power tools and home appliances are just a few of the examples on the market.

Battery powered vacuum cleaners, drills, and electric saw units were investigated. It was found these products, use brush DC or universal motors. The torque/speed variation is handled roughly by switching a 2-position gearbox unit connected to the motor shaft. That is, a low

cost design was achieved by transferring the cost of the electronic drives into a motor with mechanical parts (gearbox) thereby sacrificing efficiency and actual performance of the product for the end user application. Battery powered tools only operate at their nominal speed/torque for a short period of time before recharging the battery became necessary. As in the case of power drills and saws, small increases in torque reduced the rotational speed of the motor-controlled system. It is also interesting to note that the price of the battery charger is comparable with the price of the actual product.

Digital electronic control of motors offers much higher efficiency and better power usage (a longer operating period for the battery) at competitive cost. Despite all the obvious facts, replacing the cost of inefficient noisy motors and mechanical components with the more efficient brushless motors and digital electronics/microcontrollers in home appliances and hand-held power tools (with cords or cordless) would still require concentrated technical support and marketing efforts. Conducting a design

---

Manuscript received December 5, 2006; revised March 3, 2007

<sup>†</sup>Corresponding Author: cop1288@hotmail.com

Tel: +82-053-650-9263, Fax: +82-053-624-4736, Cheongju Univ.

<sup>\*</sup>School of Electronics and Information Engineering, Cheongju Univ

<sup>\*\*</sup>Dept. of Automatic Electrical Engineering, Yeungnam College of sci. and tech.

comparative cost analysis, and reviewing application notes for specific motor control end equipment will provide design engineers with information leading to benefits such as reduced design efforts and time spent learning about microcontroller-based systems.

Brushless DC (BLDC) motors have been used in various industrial applications and have increased demand in diverse fields because of its high efficiency, simple control compared with AC motors, low EMI, and high reliability due to the absence of brushes. Most three-phase motors, including BLDC motors need at least six PWM channels for inverter power devices such as IGBTs and MOSFETs. In order to meet these requirements, generally a single chip controller,<sup>[16,17]</sup> a special-purpose processor, a programmable logic device (PLD) or drive device to generate control signal is necessary. Using a single chip controller provides some good points, such as its small size and cost effective drive. However, if more functions are required this type of drive system will need more devices which will make this drive system more expensive. Adapting a special purpose processor or device for a BLDC motor drive presents several advantages, such as small drive size and less development time. However, these processors are more expensive than general purpose processors which eventually will increase the cost of the BLDC motor drive system.

Since the main flux of a BLDC motor is produced by permanent magnets, this motor has high power density and is capable of operating at high efficiencies while having a similar torque control performance as a DC motor<sup>[1-2]</sup>. Trapezoidal type BLDC motors are generally used for low-cost industrial applications. Therefore, low-cost applications of BLDC motors are being considered for use in many products, especially in sensorless operations<sup>[3]</sup>.

Sensorless techniques for BLDC motor control with trapezoidal back-EMFs can be classified into two categories: algebraic equation-based techniques<sup>[4-6]</sup> and back-EMF voltage sensing techniques<sup>[7-10]</sup>. The main idea behind using algebraic equations is to calculate the flux linkage from the motor parameters and voltage/current measurements. Based on the estimated flux linkage, the rotor position can be detected. This method can be operated over a wide speed range, but the motor parameters need to be known precisely and at least one

current sensor is required. Therefore, the system performance depends on the accuracy of the motor parameters.

The sensorless techniques that utilize the back-EMF voltage of the open-phase include the following methods,

- 1) Terminal voltage sensing,
- 2) Third harmonic back-EMF voltage sensing,
- 3) Freewheeling diode conduction current sensing.

When a phase is open, the back-EMF voltage which includes the information of the rotor position can be measured at the motor terminals. Since the terminal voltage sensing is simple from a hardware point of view, this approach is widely used in industry for sensorless control of BLDC motors.

The purpose of these sensorless methods is elimination of the position sensor, which is generally composed of three hall sensors mounted across from the rotor. Sensorless techniques need extra computation time and external circuitry to estimate the back-EMF compared with sensor-based systems. Therefore, sensorless techniques demand high performance processors, large program codes and large memory. Finally, instead of a position sensor, other components are required, so it is very difficult to decrease the total motor drive cost.

In order to achieve a low-cost BLDC motor drive, a general-purpose processor with hall sensors is used, instead of eliminating the position sensor, and a special purpose processor. In this paper, a general-purpose processor, such as MSP430F1232 which is an ultra low-power 16-bit RISC mixed-signal processor from Texas Instruments (TI) is used for battery powered applications. The developed control algorithm is presented and a general purpose digital I/O port is used to generate the PWM signals. To verify the proposed algorithm the operation of a three-phase BLDC motor with three hall sensors under an open-loop speed operation is described in this paper.

## 2. BLDC Motor

Permanent magnet (PM) motors are synchronous motors that have permanent magnets mounted on the rotor with armature windings located on the stator. PM motors are categorized into two types. The first type is referred to as a PM synchronous motor (PMSM) which has sinusoidal

back-EMF as shown in Fig. (1-a). The other type has a trapezoidal back-EMF and is referred to as the brushless DC (BLDC) motor shown in Fig. (1-b) [1].

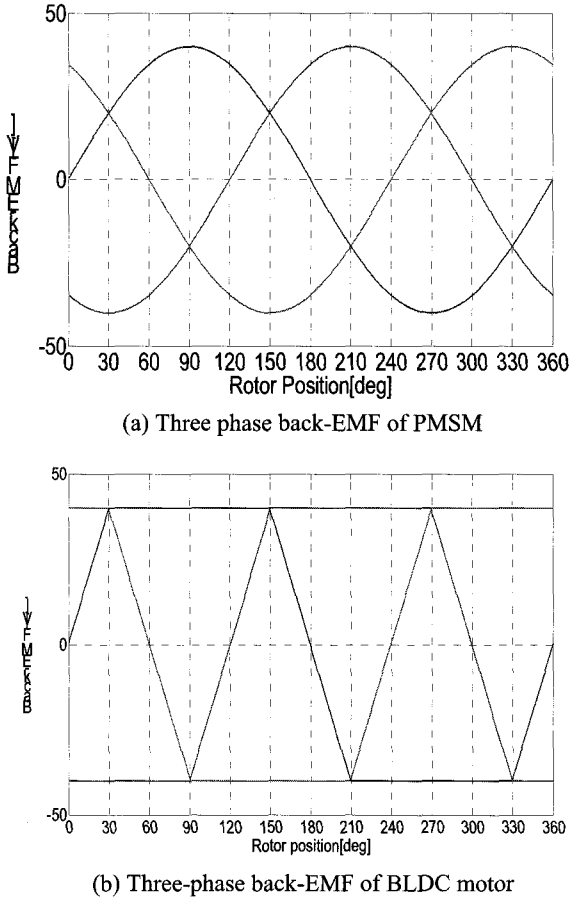

Fig. 1 The back-EMF of PM motors

In BLDC motor drives, polarity reversal is performed by power transistors switching in synchronization with the rotor position. Therefore, the BLDC motor has to use either an internal or external position sensor to detect the actual rotor position. Also the rotor position can be estimated without the need for a position sensor. However this paper uses three hall sensors to determine the actual rotor position.

In general, a BLDC motor may use either 60 deg or 120 deg commutation intervals. In this paper, a 120 degree conduction interval is used. Fig. 2 shows a schematic of the BLDC motor and the ideal current waveforms versus position. Also, the position sensors outputs are illustrated. Fig.3 shows the ideal phase current in each of the motor windings and the three-phase inverter,

respectively. According to Fig. 3 from the first interval, phase A will conduct positive DC link current while phase B will conduct negative DC link current. Phase C will be left open. As a result, only phase A and B are conducting and phase C is left silent, which means that only two switches (A\_H and B\_L) are active, while the rest (A\_L, B\_H, C\_H, and C\_L) are inactive.

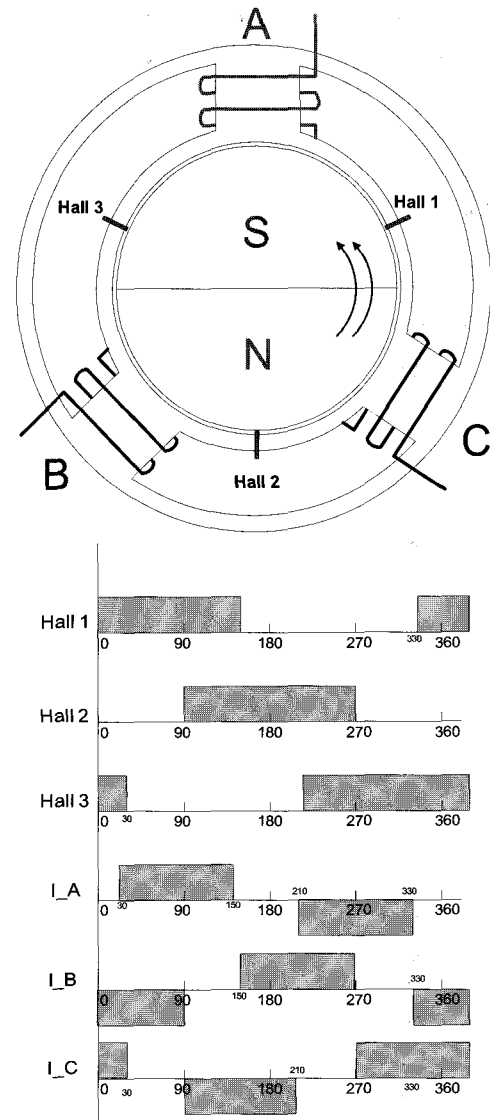

Fig. 2 BLDC motor structure and signals

During every PWM cycle to achieve this switching scheme, the desired duty cycle is imposed by the upper switch (A\_H) of the two involved switches (A\_H and B\_L) and the lower switch (B\_L) is kept on (100% duty cycle). Therefore, there is no need for dead time to be

considered for BLDC motors. Because whenever the upper switch is turned on, the lower switch of the same leg

always is already off and vice versa.

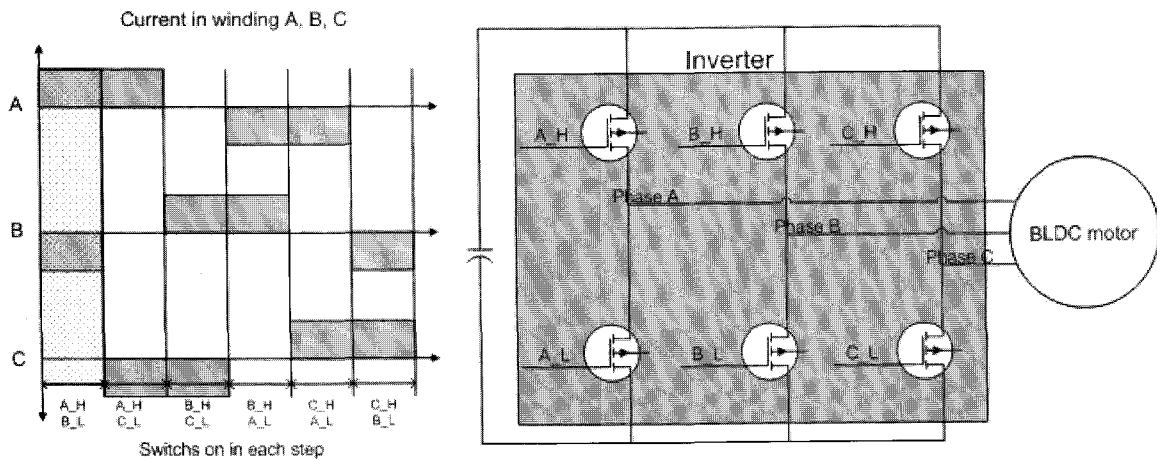

Fig. 3 Inverter configuration of BLDC motor

### 3. Proposed Algorithm

Fig. 4 shows the interrupt block diagram for generating the PWM signal using the I/O port which is called an asymmetric PWM strategy. To generate these PWM signals, P3.0-P3.5 ports are used because the MSP430F123 micro-controller does not have enough PWM channels to be directly used with three-phase motor drives and only has two PWM channels. Timer\_A has 4 modes, up, stop, up/down, and continuous mode. In this paper, it is configured in up-mode with MCLK as the timer clock source, also Timer\_A overflow interrupt and TACCR1 capture/compare interrupt are used to realize an exact PWM signal.

In order to keep the frequency constant, the CCR0 register has a fixed value, which is 200h, and the CCR1 register has a proper value to generate the desired duty ratio. The software checks the value of the CCR1 register to ensure that it does not exceed the minimum or maximum value and prevents it from rolling over.

The software flow chart for the three-phase BLDC motor with three hall sensors is described in Fig. 5. The initialization procedure includes the initialization of the watchdog timer, digital I/O, Timer\_A, ADC10 and variables. The main program consists of the initialization, start of conversion of the DC link current, hall sensor check for rotor position detection, switch signals (SW1, SW2) check for increasing the current reference or decreasing the current reference and the check for motor rotation direction (SW3).

To generate constant PWM signal, P3.0-P3.5 port is used as the PWM output port, and Timer\_A underflow interrupt (TAIFG) is served, which is called every 100msec. Also Timer\_A underflow interrupts the specific switching pattern for the BLDC motor operation based on the position sensors signals. To control the motor current, the DC bus voltage level applied to the motor using a proper PWM duty ratio is adjusted accordingly and Timer\_A CCR1 interrupt is utilized for regulating the DC bus voltage that is supplied in the motor phase. All algorithms are developed in assembly language using 422

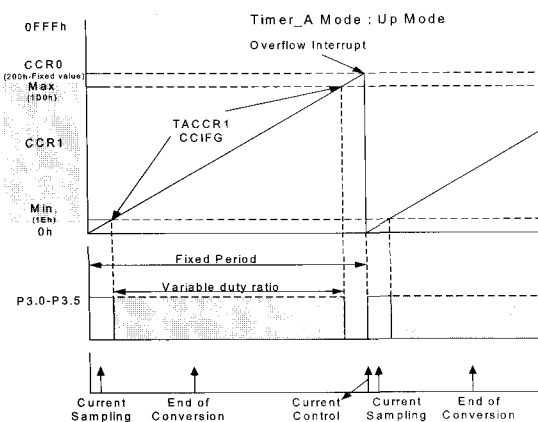

Fig. 4 Timer\_A interrupt block diagram for the PWM signal using the digital I/O

bytes of flash memory. The flash memory address is from 0xE000 to 0xFFFF, the interrupt vector from 0xFFFF to 0xFFE0, and the main code memory from 0xFFFF to

0xE000. The developed code resides in the main code memory. Therefore, there is no need to connect extra memory and peripheral devices.

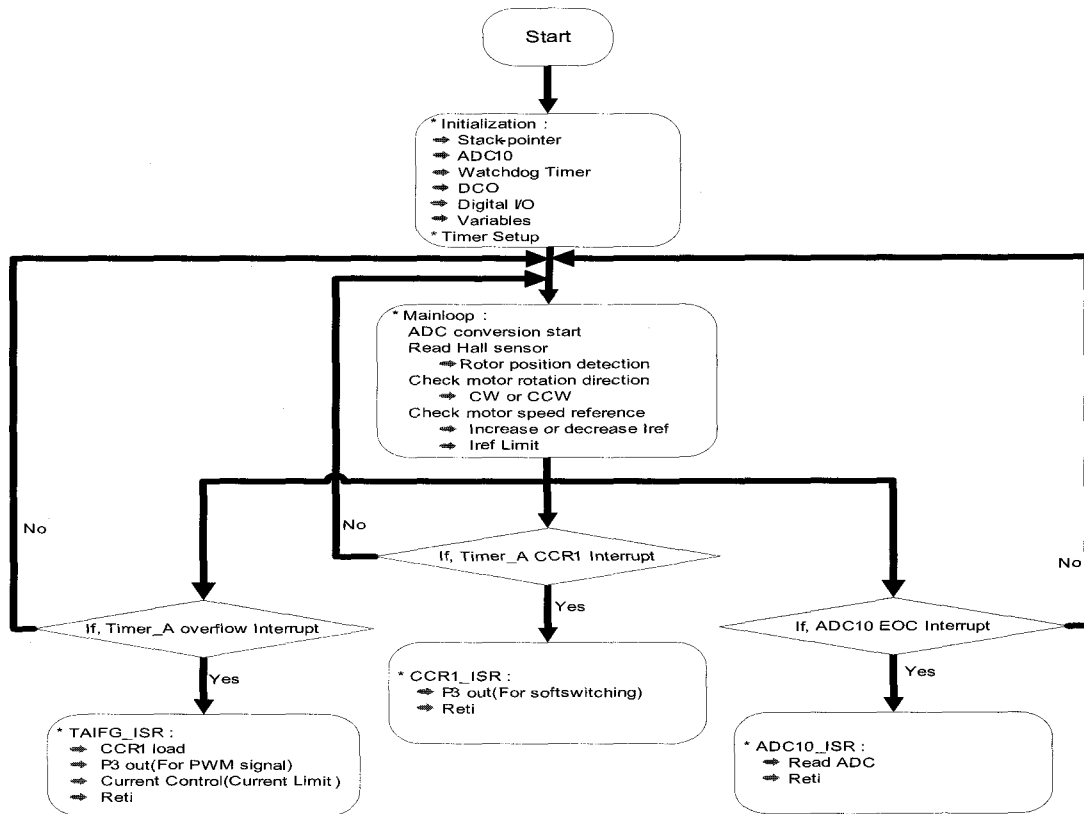

Fig. 5 Software flowchart.

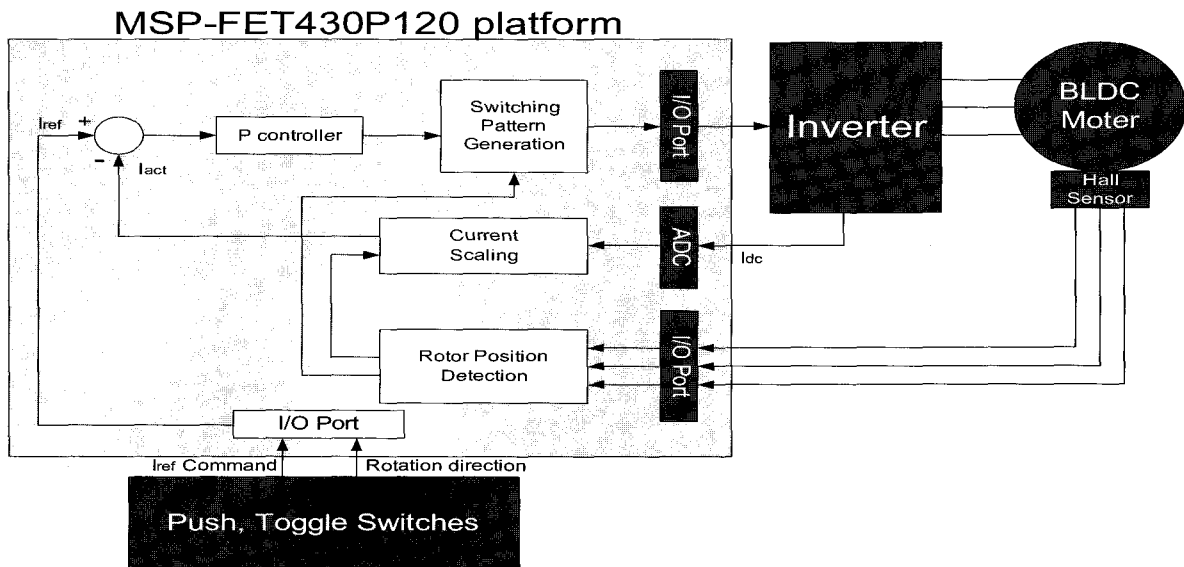

Fig. 6 The schematic of the BLDC motor drive system

Table 1 The comparison of processors for BLDC motor drive

Processor	Manufacture	1KU price(US\$)	ADC	Internal Memory	PWM Generation
MSP430F123	TI	2.30 (1 pu)	On-chip ADC(10 bit)	8k flash, 256 RAM	Not need
TMS320F2401A	TI	3.50 (1.52 pu)	On-chip ADC(10bit)	2k RAM	On-chip PWM
ST7MC1K2	ST	3.30 (1.43 pu)	On-chip ADC(10bit)	16k flash, 4k RAM	On-chip PWM
56F8013	Motorola	3.15 (1.37 pu)	On-chip ADC(12bit)	384 -1.5kRAM 8k-60k Flash	On-chip PWM

#### 4. System Configuration

Fig. 6 shows a block diagram of the BLDC motor control system used in this paper. The MSP430F123 processor receives feedback signal from the DC link current sensor which is used to provide current feedback for the closed loop current control. The rotor position information supplied by the hall sensors of the BLDC motor is estimated with the 3 external I/O ports. Actual motor current and the direction of rotation can be changed by the push and toggle switches. Fig. 6 represents the schematic of the BLDC motor drive system. To control motor current, a proportional controller is used to supply a proper switching pattern for the inverter where the three hall sensors are used. It is shown in this figure to control the BLDC drive system. Only the MSP430F123 processor is used while external timer devices for PWM generation and memory for program download are never considered. Fig. 7 shows the micro-processor used in this paper.

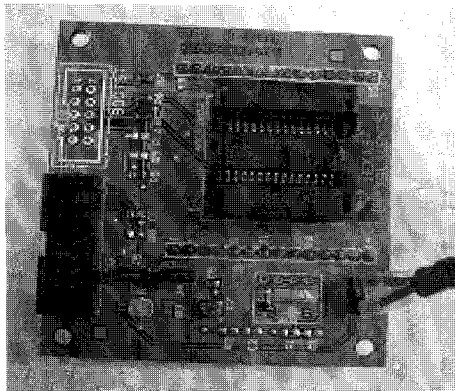

Fig. 7 The MSP430F123 microcontroller board

#### 5. Experimental Results

Fig. 8 shows the current waveforms, where Channel 1 illustrates the measured DC link current, Channel 2 represents the DC link current waveform using the current probe and Channel 4 indicates the phase current waveform using the current probe.

Fig. 9 shows the PWM signal, where Channel 1 is the A\_upper signal, Channel 2 is the B\_lower signal and Channel 3 is the C\_lower signal using the I/O port and A\_phase current waveform using a current probe. As shown in Fig.9, the upper leg and the lower leg switches are not on simultaneously. Therefore, there is no need for dead-time to be included in this example.

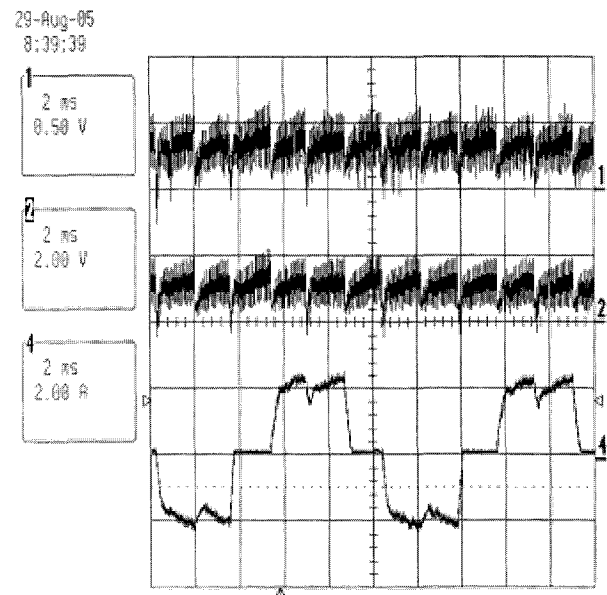

Fig. 8 DC link current and phase current

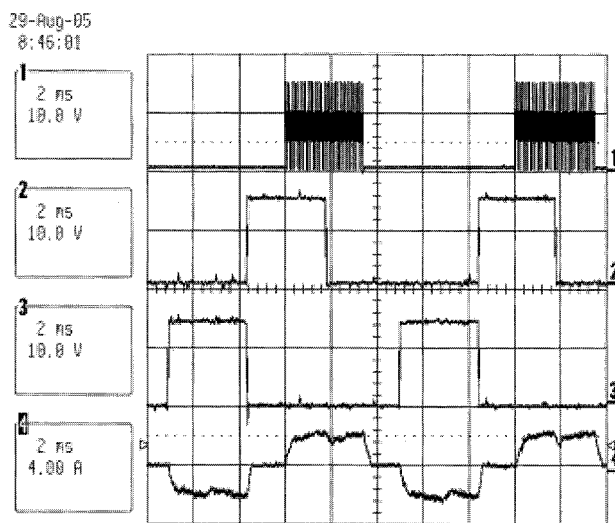

Fig. 9 PWM signals and current waveform

## 6. Conclusions

In this paper, an efficient algorithm that employs an I/O port for PWM signal generation for BLDC motor control with three hall sensors is proposed. Control of the BLDC motor does not need to consider dead-time for PWM generation, which allows proposed algorithms to use one timer and a general I/O port. The general purpose processor, Texas Instruments MSP430F123 without any peripheral devices is used to verify the proposed algorithm. The control algorithm is implemented on an experimental set up and several tests were performed. It was shown that the proposed low-cost system has satisfactory performance for industrial applications and as a result adopting the MSP430F123 processor gives at least a 37% cost reduction compared with using a special purpose processor to control the motor.

## References

- [1] J.R. Hendershot Jr. and TJE Miller, *Design of Brushless Permanent Magnet Motors*, Oxford, 1994.
- [2] T.J.E Miller, "Brushless permanent-magnet motor drives," *Power Engineering Journal*, vol. 2, no. 1, pp. 55-60, Jan. 1988.
- [3] J.P. Johnson, M. Ehsani, and Y. Guzelgunler, "Review of sensorless methods for brushless DC," in *Proc. of IEEE IAS Annual Meeting*, vol.1, pp. 143-150, 1996.
- [4] N. Ertugrul and P. Acarnley, "A new algorithm for sensorless operation of permanent magnet motors," *IEEE Transactions on Industry Applications*, vol. 30, no. 1, pp. 126-133, Jan./Feb. 1994.
- [5] N. Ertugrul and P. Acarnley, "Indirect rotor position sensing in real time for brushless permanent magnet motor drives," *IEEE Transactions on Power Electronics*, vol. 13, no. 4, pp. 608-616, July 1998.
- [6] T.H. Kim and M. Ehsani, "Sensorless control of the BLDC motors from near-zero to high speeds," *IEEE Transactions on Power Electronics*, vol. 19, no. 6, pp. 1635-1645, Nov. 2004.
- [7] J.C. Moreira, "Indirect sensing for rotor flux position of permanent magnet AC motors operating over a wide speed range," *IEEE Transactions on Industry Applications*, vol. 32, no. 6, pp. 1394-1401, Nov./Dec. 1996.
- [8] S. Ogasawara and H. Akagi, "An approach to position sensorless drive for brushless DC motors," *IEEE Transactions on Industry Applications*, vol. 27, no. 5, pp. 928-933, Sept./Oct. 1991.
- [9] G.J. Su and J.W. McKeever, "Low-cost sensorless control of brushless DC motors with improved speed range," *IEEE Transactions on Power Electronics*, vol. 19, no. 2, pp. 296-302, Mar. 2004.
- [10] J.W. Shao, D. Nolan, M Teissier, and D. Swanson, "A novel microcontroller-based sensorless brushless DC (BLDC) motor drive for automotive fuel pumps," *IEEE Transactions on Industry Applications*, vol. 39, no. 6, pp. 1734-1740, Nov./Dec. 2003.
- [11] *DSP-Based Electromechanical Motion Control*, CRC Press, 2003.
- [12] *MSP430x1xx Family User Guide*(slau049d).
- [13] *MSP430x12x Mixed Signal Microcontroller-Rev. C*(msp430f123).
- [14] *MSP-FET430 FLASH Emulation Tool User's Guide*(slau138b).
- [15] *MSP430x11x2, MSP430x12x2 Mixed Signal Micro controller- Rev. D*.
- [16] *L6235 Datasheet*.
- [17] *MC33035, NCV33035 Datasheet*.



**Nam-Hun Kim** was born in Kangwon province. He received his B.S. degrees in Control and Instrumentation Engineering from Samchuk National University, Samchuk, South Korea, in 1998. Dr. Kim received his M.S. and Ph. D. degree in Electrical Engineering from Yeungnam University, Keungsang,

Japan, in 2000 and 2003, respectively. From 2004 to 2007, he had been with the Department of Electrical and Computer Engineering, Texas A&M University, USA, where he was a Post- Doc. Researcher. He is currently an instructor at the School of Electronics and Information Engineering, Cheongju University, Korea. He is engaged in research on motor control and design, and fault diagnosis of electrical machines.

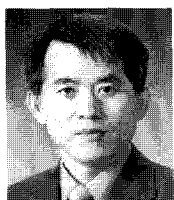

**Oh Yang** received his B.A., M.S., and Ph.D. degrees in Electrical Engineering from Han Yang University, Korea, in 1983, 1985, and 1997, respectively. From 1985 to 1997, he was a Research Engineer at LGIS R&D Lab. Department of Industrial Control, Anyang, Korea. He was a Visiting Professor at A&M University, Texas, USA, in 2006. He is currently an Associate Professor at the School of Electronics and Information Engineering, Cheongju University, Korea. His research interests include motor drives, power factor correction, and communication systems for industrial controls.

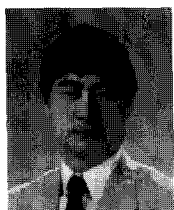

**Min-Huei Kim** was born in Kyengbuk Province, Korea on August 25, 1951. He received his B.S. and the M.S. degrees from Yeungnam University, Kyeungbuk, Korea, and Ph.D. degree from the University of Chung-Ang, Seoul, Korea, all in Electrical Engineering, in 1974, 1980, and 1989, respectively. He worked for Shinil Industrial Company in Research and Development for electric motor from 1977 to 1978 in Seoul, Korea. In 1978, he joined as an Instructor of Yeungnam Junior College, Daegu, Korea. He became an Assistant Professor, Associate Professor and Professor in 1981, 1987, 1992, respectively. From 1993 to 1995, he was a Visiting Research Professor in the Power Electronics Application Center (PEAC) at The University of Tennessee, Knoxville, USA. He is currently a Professor in the Department of Electrical Automatic Engineering at Yeungnam College of Science and Technology, Daegu, Korea. His research interests are in control systems of motor drives, power converters, neural networks and their application in power electronics. He is a member of the KIPE and JIEE, a life member of KIEE, and a senior member of IEEE.