

Investigation of Interplay between Driving Voltage of MZ Modulators and Bandwidth of Low-pass Filters in Duobinary Modulation Formats

Dong-Soo Lee*

Abstract

We have theoretically investigated the effects of the interplay between the driving voltage of Mach-Zehnder (MZ) modulators and the bandwidth of low-pass filters (LPF) in 10[Gb/s] duobinary modulation systems. For the change of driving voltage ratios(driving voltage/ switching voltage), the transmission performance has been evaluated over 200[km] of single-mode fiber(SMF) systems. For driving voltage ratios with smaller than 100[%], the transmission performance has been maintained and greatly affected by the bandwidth of LPFs than the driving voltage. For driving voltage ratios with larger than 100[%], the transmission performance has been degraded and is not sensitive to the bandwidth of LPFs. To see the limitation of driving voltage, we have reduced the driving voltage ratio to 50[%]. Our results suggest that 10[Gb/s] duobinary signals with driving voltage ratio with smaller than 100[%] have been transmitted over 200[km] SMF within 2[dB] power penalty without dispersion compensation. For the driving voltage ratio with 50[%], we have verified that the transmission performance was maintained.

Key Words : Driving voltage ratio, Mach-Zehnder modulator, Duobinary modulation, Receiver sensitivity, Chirp, Eye diagram, Bit error rate(BER), Extinction ratio, Low pass filter(LPF)

1. Introduction

Optical duobinary transmissions have been highlighted as an attractive method to overcome the fiber chromatic dispersion in high capacity transmission systems[1-4]. Duobinary technology, first described by A. Lender in the 1960's[5], was

recently applied to over 10[Gb/s] optical transmission systems. It has been demonstrated over 200[km] transmission using the standard single-mode fiber(SMF) at 10[Gb/s] without a dispersion compensation scheme[1-2]. Moreover, it can be applied to increase the transmission capacity in dense wavelength division multiplexed systems due to a relatively small spectral bandwidth of duobinary modulated signals generated from eliminating high frequency components by low-pass filters[6].

Most of the papers have reported that the low

* Main author : joined the faculty of the Division of IT, Kimpo College
Tel : +82-31-999-4776, Fax : +82-31-999-4775
E-mail : dslee@kimpo.ac.kr
Date of submit : 2006. 9. 7
First assessment : 2006. 9. 11
Completion of assessment : 2006. 9. 19

dispersion penalty of duobinary modulated signals results from their small spectral bandwidth[1-2]. On the other hand, the relevant criterion allowing the assessment of the dispersion limit is the phase characteristics of duobinary modulated signals rather than the spectral bandwidth[7-8]. The prechirping method has been proposed in duobinary modulation as in the conventional NRZ(Non-return to zero) modulation to compensate the group velocity dispersion by reducing the spectral component[9]. The interplay between the residual chirp and the applied chirp as well as the dependence of the electrical filter bandwidth has been investigated[10]. The residual chirp is accompanied from the finite extinction ratio of LiNbO₃ Mach-Zehnder(MZ) modulators and the applied chirp is adjusted by the applied voltage ratio between two electrodes. The effects of changing the driving voltages have been slightly investigated in optical duobinary transmitters[11].

Although the duobinary modulation format has several advantages, duobinary transmitters have severe demerits. Compared to transmitters of the NRZ modulation format, one drawback is high complexity and cost by using LPFs and a precoder. A simple precoder and a single-electrode MZ modulator may overcome these problems. The other drawback is requirement for high driving voltage to modulators, which is twice larger than that of the NRZ modulation format. This results in growing the cost by using high power electrical amplifiers. Therefore, it is necessary to investigate the transmission performance by driving voltage ratio in duobinary transmissions. Since the slight change of the bandwidth of LPFs severely affects the transmission performance at a low driving voltage ratio, the effect of LPF bandwidth should be considered at the same time. In order to implement an optimum duobinary transmitter, it is very

important to investigate the effects of the bandwidth of LPFs as well as the driving voltage ratio.

In this paper, we theoretically investigate the effect of the interplay between the driving voltage of MZ modulators and the bandwidth of LPFs in duobinary transmitters so that we can understand the limitation of the driving voltage ratio. The optimum driving voltage and the bandwidth of LPFs are found for 10[Gb/s] optical transmission systems with SMF over 200[km]. To verify the simulation results, 10[Gb/s] duobinary transmission experiments were performed. The duobinary signal with 50[%] driving voltage ratio can be transmitted over 200[km] SMF successfully.

Section 2 describes modeling of MZ modulators. The electrical field, the chirp parameter, and the extinction ratio are explained in MZ modulators. The simulation setup of a duobinary transmission system is described. In section 3, the simulation results for the interplay between the driving voltage and the bandwidth of LPFs are investigated and compared from the calculated BERs and the eye-diagrams. Using the experimental results, the simulation results are verified in section 4. Finally, conclusions are presented in section 5.

2. Simulation Setup

For non-ideal MZ modulators, the asymmetric power ratio of both arms is not exactly 50/50. Since the losses through each arm is not identical, the asymmetric optical power causes a finite extinction ratio of MZ modulators. In the asymmetric conditions, the output electric field of MZ modulators E_{out} can be modeled using the parameter Γ as follows[12]:

$$E_{out} = \frac{E_0}{2} \exp\left(\frac{j\pi V_1(t)}{V_\pi}\right) + \frac{\Gamma E_0}{2} \exp\left(\frac{j\pi V_2(t)}{V_\pi}\right) \quad (1)$$

where Γ is the scaling factor between 0 and 1 that accounts for an asymmetric power ratio. E_0 is the electric field of CW laser source, $V_1(t)$ and $V_2(t)$ are the voltages applied to two electrodes, and V_π is the switching voltage of modulators.

The parameter Γ , related to the extinction ratio (ϵ), can be defined as the ratio of a maximum to a minimum power by $\Gamma = (\sqrt{\epsilon} - 1) / (\sqrt{\epsilon} + 1)$. For non-ideal devices ($\Gamma \neq 1$), MZ modulators also produce the residual chirp and the finite extinction ratio. Although the residual chirp of MZ modulators is an inherent characteristic, the amount of total chirp can be adjusted by the applied chirp[14]. To control the driving voltage ratio, $V_1(t)$ and $V_2(t)$ are driven to two electrodes of MZ modulators.

The schematic diagram of a transmission link used in our simulation is shown in Fig. 1.

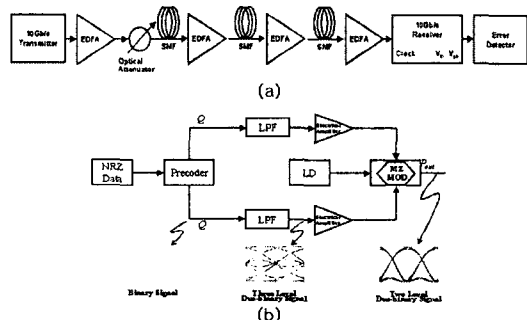

Fig. 1. Schematic diagrams of duobinary transmission systems:(a) a link configuration and (b) a schematic of duobinary transmitter

Optical signals at 1550[nm] wavelength were transmitted over 200[km] SMF. The signal was modulated at 10[Gb/s] with 2^7 PRBS (Pseudo-Random Binary Sequence) using an MZ modulator. The type of LPFs used in duobinary transmitters is a fifth-order Bessel-Thomson filter with the cutoff frequency range of 2.0 to 3.2[GHz]. Different driving voltages were applied to the

dual-electrode MZ modulator so as to provide the driving voltage ratios of 50 to 150[%] normalized to the switching voltage (V_π). The typical switching voltage was set to 4[V], a typical value for commercial MZ modulators. A gain-flattened EDFA(Erbium-Doped Fiber Amplifier) was used as a booster amplifier. The overall system was composed of 3 spans (80[km] \times 3). EDFAs were used to compensate the fiber loss in the link. The transmission performance was evaluated by the calculated receiver sensitivities at 10^{-12} BER using a PIN receiver[13]. For the pulse propagation in SMFs, the nonlinear Schrödinger equation was solved by the split-step Fourier method[14].

3. Calculated Results of Transmission Performance and Discussions

A. Eye-diagrams

The calculated eye-diagrams with different driving voltage ratios are shown in Fig. 2.

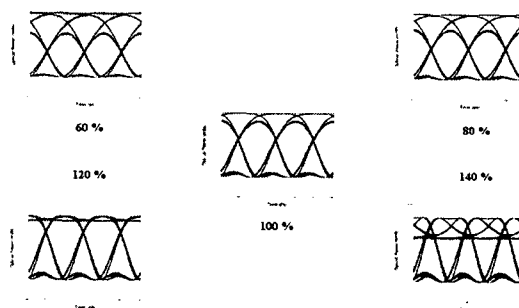

Fig. 2. Calculated eye-diagrams as a function of driving voltage ratio from 60[%] to 140[%]

The optimum 3[dB] bandwidth frequency of the LPFs was used to be 2.7[GHz]. The driving voltage ratio with less than 100[%] resulted in a small magnitude of ‘mark’ level and a wide ‘space’

level by the reduction of the signal bandwidths. The reduction of signal bandwidths results from lower extinction ratio due to the small magnitude of 'mark' level. The driving voltage ratios with larger than 100[%] caused thicker 'mark' level and narrower 'space' level by the over-driving voltage and the increased signal bandwidth. The thicker 'mark' level results from the overlap of eye-diagrams due to the over-driving voltage in the transfer curve of the MZ modulator. Therefore, the driving voltage ratio with larger than 100[%] makes distortion in the eye-diagrams.

B. Receiver sensitivities

Fig. 3 and 4 show the contour plots of receiver sensitivities at 10^{-12} BER with the transmission distances of 0[km] and 160[km], respectively.

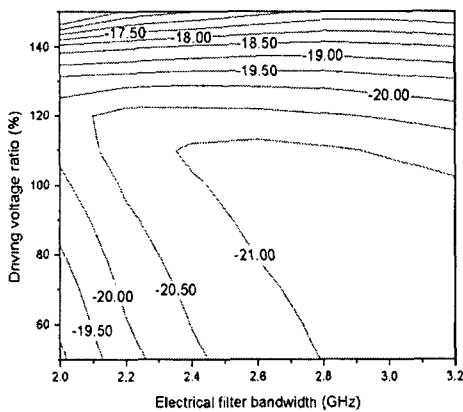

Fig. 3. Contour plots of calculated receiver sensitivities((dBm)) at 10^{-12} BER for the bandwidth of LPFs and the driving voltage ratio of MZ modulator at 0(km) transmission

In Fig. 3, the transmission performance of a driving voltage ratio with larger than about 110[%] is affected by the change of the driving voltage dominantly regardless of the bandwidth of LPFs. For the same bandwidth of LPFs, the transmission

performance was degraded by the change of the driving voltage ratio. This results from thicker eye-diagrams due to the overlap of 'mark' level, such as the eye-diagrams of Fig. 2. In driving voltage ratios smaller than about 100[%], on the other hand, the bandwidth of LPFs strongly affects to the transmission performance. The transmission performance is governed by the combination of two factors between the bandwidth of LPF and the driving voltage ratio. So, the accurate control of the bandwidth is inevitable for driving voltage ratios with smaller than about 100[%].

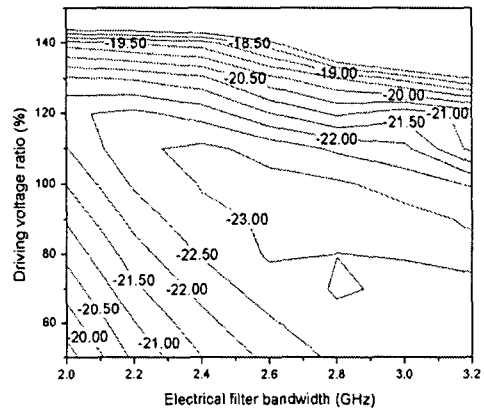

Fig. 4. Contour plots of calculated receiver sensitivities((dBm)) at 10^{-12} BER for the bandwidth of LPFs and the driving voltage ratio of MZ modulator after 160(km) transmission

In Fig. 4, the slightly different characteristics are shown at 160[km] transmission distance, compared to the back-to-back case. In driving voltage ratios with larger than 110[%], the effect of the driving voltage ratio to the transmission performance is significantly increased. Though a very small change of driving voltage ratios occurs for the same bandwidth of LPFs, the transmission performance is degraded. The optimum regions, which are in about 2.6 to 3.0[GHz], exists for the bandwidth of LPFs. This is related to two factors.

One is the effect of the chromatic dispersion due to the signal bandwidth. Since the chromatic dispersion is inversely proportional to the signal bandwidth, a high cutoff frequency results in large chromatic dispersion. Thus the small bandwidth of LPFs causes the improved tolerance to the chromatic dispersion. The other is the magnitude of peak-to-peak chirps at the center point of 'space' level. Large peak chirp in the '0' bit period originates from the abrupt phase shift to make two level duobinary signals from three level signals in the MZ modulator. Since the peak chirp maintains lower 'space' level during transmitting signals through a fiber, the transmission performance can be improved by low 'space' level.

Fig. 5 shows the contour plot of calculated peak-to-peak chirp.

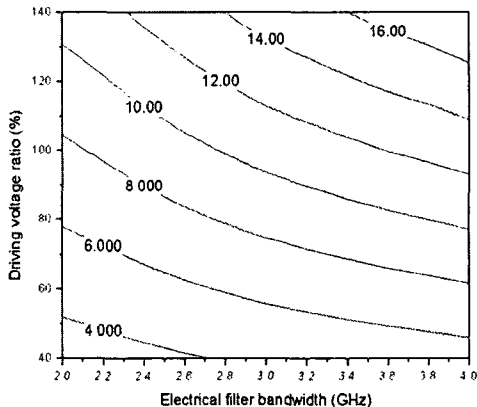

Fig. 5. Contour plots of calculated peak-to-peak chirp((GHz)) at 10^{-12} BER for the bandwidth of modulators and driving voltage ratio

The chirps are proportional to the signal bandwidth and the driving voltage ratio. Since the peak-to-peak chirp maintains 'space' level due to the power shift at the center point at the '0' bit, the transmission performances are affected by the magnitude of this chirp. In Fig. 4, the change of the transmission performance is due to the change

of peak-to-peak chirp with reduced driving voltage ratio.

The calculated receiver sensitivities as the functions of transmission distance for the driving voltage ratio are shown in Fig. 6.

For driving voltage ratios with smaller than 100[%], the transmission performance is similar to the 100[%] driving voltage case. It indicates that the under-driving voltage did not degrade the transmission performance. For driving voltage ratios larger than 100[%], however, the transmission performance was degraded, compared to the 100[%] driving voltage case. This is due to the thicker 'mark' level caused by the overlap of signals. From those results, it is wise to commend that the driving voltage ratios less than 100[%] should be used to maintain the transmission performance effectively.

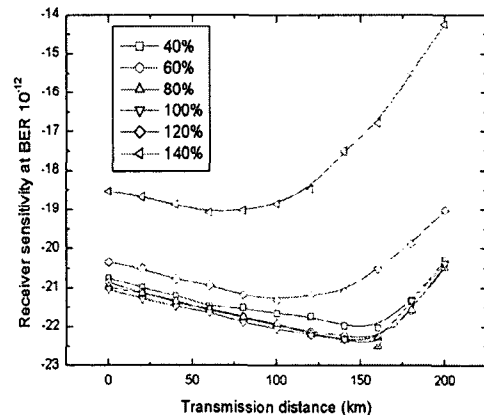

Fig. 6. Calculated receiver sensitivities((dBm)) at 10^{-12} BER for driving voltage ratio of MZ modulators as a function of transmission distance

4. Experimental Verification of Transmission Performance

The experimental setup of 10[Gb/s] duobinary transmission system is shown in Fig. 1. The setup is the same configuration used to the simulation. A

DFB (distributed-feedback) laser of 1550[nm] wavelength was used. The signal was modulated at 10[Gb/s] with $2^{31}-1$ PRBS in an MZ modulator. The bandwidth of a LPF was used by 2.8[GHz], which was optimized by the simulation in Fig. 4. The fiber launching power was 3[dBm] and the measured optical signal-to-noise ratio (OSNR) was 28[dB]. For the driving voltage ratios with 50[%] and 100[%], the transmission performance was measured.

The measured eye-diagrams are shown in Fig. 7.

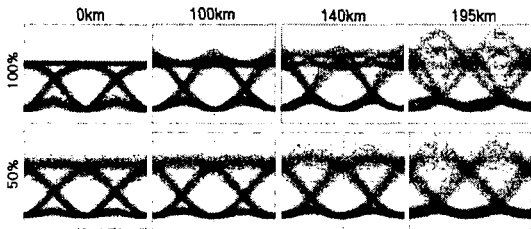

Fig. 7. Measured eye-diagrams for driving voltage ratio of MZ modulators as a function of transmission distance

For the driving voltage ratio of 100[%], the clearly-opened eye-diagram was obtained at 0[km]. The shape of the eye-diagram has the typical duobinary characteristics of narrow ‘space’ level. As the transmission distance is increased over 140[km], eye-diagrams were distorted by the fiber chromatic dispersion. For the driving voltage ratio of 50[%], the similar characteristics were obtained as a function of transmission distance, except for the eye-diagram at 0[km], which has wider ‘space’ level than 100[%] driving voltage ratio. This is due to lower extinction ratio in a lower ‘mark’ level. In the duobinary modulation format, the ‘space’ level was formed by a ‘null’ point of the transfer curve in the MZ modulator.

Fig. 8 shows the measured and the calculated bit error rate (BER) characteristics.

At 0[km], the BER characteristics are governed

by the extinction ratio. The BER characteristics of the 50[%] driving voltage ratio is close to those of the 100[%] driving voltage ratio. As the transmission distance is increased up to 150[km], both BER characteristics were improved due to the characteristics of the duobinary signals regardless of the driving voltage ratios. More improvement of BER characteristics at the 100[%] driving voltage ratio was obtained due to the higher extinction ratio than the 50[%] driving voltage ratio. Even though the eye-diagrams were significantly distorted by the accumulated fiber chromatic dispersion at 200[km] for both cases, we obtained similar BER characteristics for both the driving voltage ratios. The error free transmission was obtained up to 200[km] regardless of the driving voltage ratio.

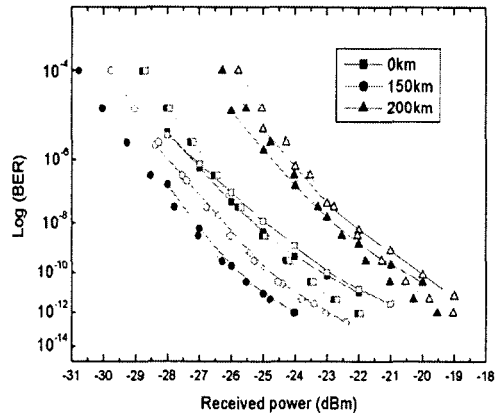

Fig. 8. measured and calculated BER characteristics for driving voltage ratio of MZ modulators as a function of transmission distance: closed symbol is 100[%] driving voltage ratio, and open symbol is 50[%] driving ratio: measured BER(solid line) and calculated BER(dot line)

5. Conclusions

We have investigated the effects of the interplay between the driving voltage of MZ modulators and

the bandwidth of LPFs and the limitation of the driving voltage ratio. The optimum bandwidth of LPFs was found to be 2.6 to 3.0[GHz]. For the low-driving voltage, the bandwidth of LPFs affected the transmission performance severely. For the driving voltage ratio of larger than 100[%], however, the impact of the bandwidth of LPFs was negligible. The over-driving voltage of the MZ modulator resulted in a severe degradation of the transmission performance due to the thicker 'mark' level. Since the under-driving voltage maintained the transmission performance, 10[Gb/s] duobinary signals were transmitted over 200[km] SMF with a loss less than 2[dB] power penalty without dispersion compensation. We have obtained a good agreement between the simulation results and the experimental results. Therefore, the drawbacks of duobinary modulation format including high cost and a large driving voltage can be overcome using a low-driving voltage.

References

- [1] A. J. Price, L. Pierre, R. Uhel, and V. Havard, "210[km] repeaterless 10[Gb/s] transmission experiment through nondispersion-shifted fiber using partial response scheme," *IEEE Photon. Technol. Lett.*, vol. 3, pp. 1219-1221, 1995.
- [2] L. Pierre, J. P. Thiery, and D. Penninckx, "243[km], 10[Gb/s] transmission experiment through standard fiber and impact of self-phase modulation using partial response scheme," *Electron. Lett.*, vol. 32, pp. 673-674, 1996.
- [3] K. Yonenaga and S. Kuwano, "Dispersion-tolerant optical transmission system using duobinary transmitter and binary receiver," *J. Lightwave Technol.*, vol. 15, pp. 1530-1537, 1997.
- [4] S. Aisawa, J. Kani, M. Fukui, T. Sakamoto, M. Jinno, S. Norimatsu, M. Tamada, H. Ono, and K. Oguchi, "A 1580[nm] band WDM transmission technology employing optical duobinary coding," *J. Lightwave Technol.*, vol. 17, pp. 191-198, 1999.
- [5] A. Lender, "Correlative digital communication techniques," *IEEE Trans. Commun. Technol.*, vol. 12, pp. 128-135, 1964.
- [6] T. Ono, Y. Yano, K. Fukuchi, T. Ito, H. Yamazaki, M. Yamaguchi, and K. Emura, "Characteristics of optical duobinary signals in terabit/s capacity, high-spectral efficiency WDM systems," *J. Lightwave Technol.*, vol. 16, pp. 788-796, 1998.
- [7] D. Penninckx, G. Vendrome, M. Maignan, and J. C. Jacquinet, "Experimental verification of the phase-shaped binary transmission (PSBT) effect," *IEEE Photon. Technol. Lett.*, vol. 10, pp. 612-614, 1998.
- [8] D. Penninckx, L. Pierre, J-P. Thiery, B. Clesca, M. Chbat, and J-L. Beylat, "Reduction between spectrum bandwidth and the effects of chromatic dispersion in optical transmissions," *Electron. Lett.*, vol. 32, pp. 1023-1024, 1996.
- [9] A. Djupsjöbacka, "Prechirped duobinary modulation," *IEEE Photon. Technol. Lett.*, vol. 10, pp. 1159-1161, 1998.
- [10] Sung Kee Kim, Jaehoon Lee and Jichai Jeong, "Transmission Performance of 10Gbps Optical Duobinary Transmission Systems Considering Adjustable Chirp of Nonideal LiNbO₃ Mach-Zehnder Modulators Due to Applied Voltage Ratio and Filter Bandwidth," *IEEE Journal of Lightwave Technology*, Vol. 19, No. 4, pp. 465-470, 2001.
- [11] J. M. Gené, R. Nieves, A. Buxens, C. Peucheret, J. Prat, and P. Jeppesen, "Reduced Driving Voltage Optical Duobinary Transmitter and Its Impact on Transmission Performance Over Standard Single-Mode Fiber," *IEEE Photon. Technol. Lett.*, vol. 14, pp. 843-845, 2002.
- [12] A. H. Gnauck, S. K. Korotky, J. J. Veselka, J. Nagel, C. T. Kemmerer, W. J. Minford, and D. T. Moser, "Dispersion penalty reduction using an optical modulator with adjustable chirp," *IEEE Photon. Technol. Lett.*, vol. 3, pp. 916-918, 1991.
- [13] Y. K. Park, S. W. Granlund, "Optical Pre-amplifier Receivers: Application to Long-Haul Digital Transmission," *Optical Fiber Technol.*, Vol. 1, pp. 59-71, 1994.
- [14] G. P. Agrawal, *Nonlinear Fiber Optics*, New York: Academic Press, 1989.

Biography

Dong-Soo Lee

Received the B.S. degree in electronics engineering from Korea University, Seoul, Korea in 1981, the M.S. degree in electrical engineering from Minnesota University, twin cities, MN, in 1987, and the Ph.D degree in radio science and engineering from Korea University in 1999. In 2000, he joined the faculty of the Division of IT, Kimpo College. His current research interests include packaging of optical devices and modulation formats for high speed optical communication systems.