

Selection of a Competent Wireless Access Point for High Wireless Bandwidth

Ji Yeon Park* and Kitae Hwang*

Abstract: Wireless LANs are becoming more widespread because of the rapid advance of wireless technologies and mobile computers. In this paper, we present the design and implementation of a system to help mobile users to select the most competent AP. By monitoring the network traffic of APs within the local LAN in real time, this system offers the mobile user the network utilizations, locations, and signal strengths of APs online. Based on the information, the user can select a competent AP with a high wireless bandwidth. Finally, we verified the accuracy of monitoring and calculating with regard to the utilizations of APs through real experiments.

Keywords: WLAN, AP, SNMP, Network Utilization

1. Introduction

Wireless LANs are becoming more widespread in numerous companies, schools, and organizations to support an increasing population of mobile computer users. The mobile device connects to one of the APs (Access Points) within the wireless signal bound so as to connect to a wired network. The AP is a device for connecting wireless communication devices together to a wired network, and can relay data between wireless devices and wired devices [1]. If a mobile user can obtain information about the locations, current network traffics, and signal strengths of APs online, he can select an AP that is competent enough to get a high wireless communication bandwidth by considering the distance to the AP from the user and the current utilization and signal strength of the AP.

In order to analyze wireless network traffic, technologies such as tcpdump [2], logs of AP, and SNMP (Simple Network Management Protocol) [3] have generally been used [4,5,6]. Tcpdump is useful but is not appropriate for real-time applications because it takes a long time to analyze captured packets. Also, the majority of the APs available on the market lack a function with which to deliver their logs to other computers in real-time. However, because most APs support SNMP, it is very realistic to use SNMP to analyze the wireless network utilization of the AP.

In this paper, we present the design and implementation details of a system conceived to help mobile users to select the most competent AP within the wireless LAN. The monitoring server of this system collects the traffic data on APs through SNMP, calculates the network utilization of each AP, and offers them to mobile users. The client

software installed in the mobile device connects to the server, gets the utilization value of each AP, and selects the most competent AP by considering together the wireless signal strengths of the APs.

The rest of this paper is organized as follows. In sections 2 and 3, we describe the design and implementation of the system in detail; in section 4 we verify the accuracy of the calculation of AP utilization through real experiments; and, in section 5, we present our conclusion.

2. System Design

2.1 System Model

We designed our system as a server-client model as shown in Fig. 1.

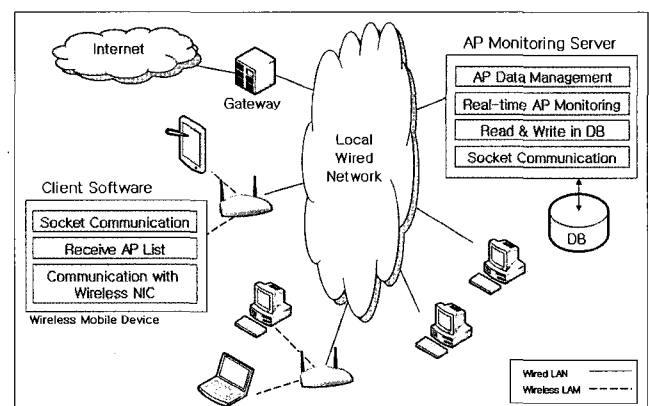

Fig. 1. System Model

The server collects all the traffic information of all the APs installed within the local LAN through SNMP. The traffic information of each AP is collected in real-time periodically, and is immediately converted to a utilization

Manuscript received November 28, 2006; accepted December 19, 2006.
This Research was financially supported by Hansung University in the year of 2006.

Corresponding Author: Kitae Hwang

* Dept. of computer Engineering, Hansung University, Seoul, Korea
(jgunny80@hansung.ac.kr, calafk@hansung.ac.kr)

value for each AP. To help its user to select the most competent AP, the client software receives a list of n APs with the lowest utilization from the server on demand and concurrently measures the wireless signal strengths of the nearby APs; it then shows all the information to its user. Thereafter, the user can select the most competent AP that is able to give the highest wireless communication bandwidth. Sometimes, the user may have to move far away to the location where the AP is installed.

2.2 AP Monitoring Server

The server is built with four different modules - a user interface module, an AP monitoring module, a DB management module, and a client service module - as shown in Fig. 2.

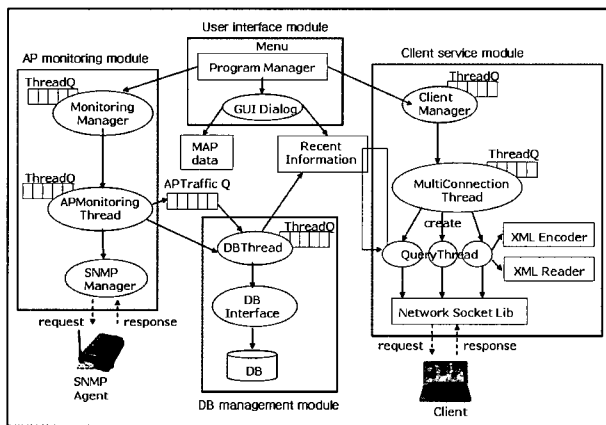

Fig. 2. AP Monitoring Server

The user interface module communicates with the administrator and shows network traffic statistics about each AP within the local LAN. The AP monitoring module gathers traffic information from all of the APs listed on the AP Map through SNMP, and calculates the network utilization of each AP. It then hands the traffic data and utilization values over to the DB management module, which saves them to a permanent DB. The AP Map is a list of installed APs within the local LAN. The recent network utilizations of all APs are maintained in a sorted form in the memory, and n APs with the lowest utilizations among them are delivered to the client on demand. The client service module runs in multithread for multiple network connections so that it can process concurrent requests from multiple clients.

2.3 Collecting AP traffic

Table 1. MIB Objects

MIB Objects	Contents
ifType	The type of interface
ifSpeed	The bandwidth of the interface
ifInOctets	The total number of octets received on the interface
ifOutOctets	The total number of octets transmitted from the interface

The AP maintains traffic information in the MIB internally and installs the SNMP service. Our server sends an SNMP GET command to each AP periodically to gather the traffic information. Currently, we have experimented with 145 APs. Table 1 shows some important MIB objects.

2.4 Calculation of Network Utilization

The network utilization is usually a ratio of the data traffic transferred by all interfaces to the full bandwidth in a networked device. We define the network utilization of an AP as the following expression:

$$Util(\Delta t) = \frac{((8 * (ifInOctets(\Delta t) + ifOutOctets(\Delta t))) / \Delta t) / ifSpeed) * 100, \tag{1}$$

where Δt is a collecting interval with the unit of one second, and $ifInOctets(\Delta t)$ and $ifOutOctets(\Delta t)$ are the numbers of bytes received on the network interface or transmitted from the network interface during Δt , respectively.

2.5 Client software

The software architecture of the client is described as shown in Fig. 3. It consists of three modules: a server connection module, an AP connection module, and a user interface.

The server connection module makes a query to get the list of APs with the lowest utilizations, receives it, and delivers it to the user interface module. The list contains the locations and utilizations of the APs. The AP connection module calls the NDISUIO device driver [7,8] installed in the Windows operating system in order to acquire certain information such as the wireless signal strength and the MAC address, etc, from the APs installed nearby. The information is delivered to the user interface module together with the list of APs described previously. The user can select an AP with high signal strength and low utilization from the given information. The user could in fact select an AP with the lowest utilization but far away at the expense of short distance: the user will then have to walk to the AP.

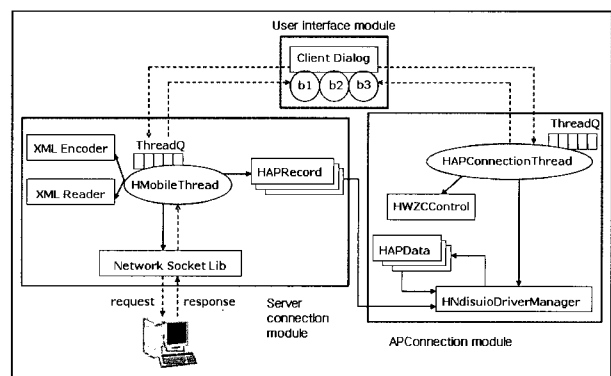

Fig. 3. Client software

2.6 XML for communication

XML is used to communicate between the server and the client. They give and take XML messages through a TCP socket. The XML message samples are shown in Fig. 4.

```
<?xml version="1.0" encoding="ISO-2022-KR" ?>
<MobileService type="q">
  <Query>
    <Target>low</Target>
    <Size>1</Size>
  </Query>
</MobileService>
```

a. XML Message to the Server

```
<?xml version="1.0" encoding="ISO-2022-KR" ?>
<MobileService type="r">
  <Response>
    <APRecord>
      <Rank>1</Rank>
      <APID>4</APID>
      <APIP>172.19.68.5</APIP>
      <APMacAddress>00-30-8D-1D-46-ED</APMacAddress>
      <APName>HW-1700AP</APName>
      <Location>공학관A동 2층#1/2</Location>
      <Utilization>0.010</Utilization>
    </APRecord>
  </Response>
</MobileService>
```

b. XML Message to the Client

Fig. 4. XML message sample

3. Implementation

Windows XP was used for the platform while C++ was used for the programming language in our implementation in both the server and the client. To collect the traffic information from the APs, SNMPAPI and MGMTAPI libraries were used. The NDISUIO (Network Driver Interface Specification User Mode I/O) driver was used to acquire information from IEEE 802.11b (currently connected AP, signal strengths of nearby APs, etc). We tested our system with the APs installed at Hansung University. In total 145 APs have been polled by the server periodically.

Fig. 5 and Fig. 6 show the GUIs for the server and the client respectively. The left-hand side of Fig. 5 shows the results of real-time monitoring such as the id, utilization, wireless communication error rate, and location of each AP. The right-hand side of Fig. 5 shows a real-time graph representing the utilization of the AP selected by the monitoring user (AP number 90 in this case).

The client GUI in Fig. 6 shows information concerning the 10 APs with the lowest utilization in increasing order and some information regarding APs that are connectable in the current location of the mobile user; it also contains AP MAC addresses and signal strengths. The mobile user can select an AP from the available AP list on both the left- and right-hand sides. Possibly, if the user wants to connect to the AP with the lowest utilization at the expense of short distance, the user will have to walk a long way to the location of the AP.

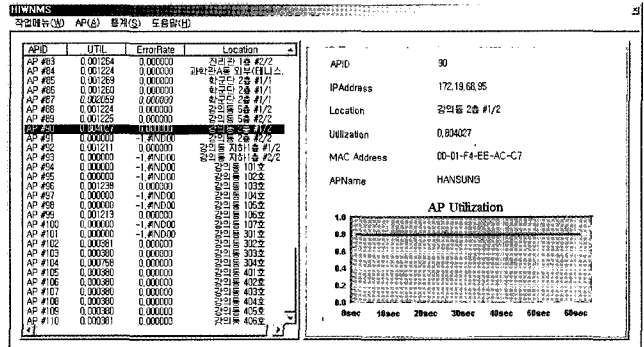

Fig. 5. GUI of the server

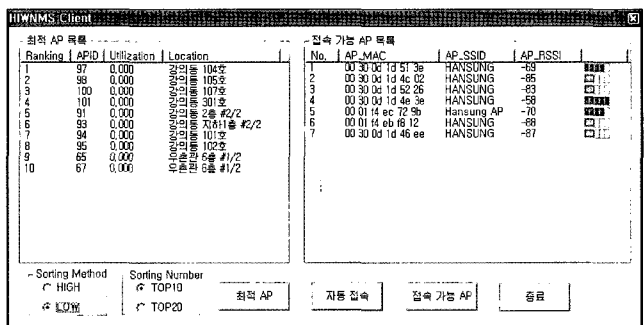

Fig. 6. GUI of the client

4. Experiments for verification

We conducted experiments in order to verify the correctness of the server program in collecting real traffic data from the APs and calculating its utilization.

4.1 Estimated network utilization of AP

We used APs with a bandwidth of 54Mbps in our experiments. So in expression (1) *ifSpeed* is equal to 54Mb. According to expression (1), the estimated network utilization of the AP is calculated. Some are shown in Table 2.

Table 2. Estimated network utilization of an AP

Traffic(Mbps)	1	2	3	4	5	6
Estimated utilization (%)	1.85	3.70	5.56	7.40	9.26	11.11

4.2 Results

First, we generated 1~5Mbps of network traffic for 30 minutes on a specially installed laptop, and in real time the server measured the utilization value of the AP to which the laptop was connected. This is depicted in Figure 7. The measured AP utilization was almost the same as the estimated utilization, as compared with Table 2.

Second, we placed 4 laptops in different locations so that they could be connected to different APs each other. Then we generated 5Mbps of network traffic for each laptop. Fig. 8 shows the results obtained after the server measured the network utilizations of the APs for 30 minutes: the

measured utilizations are almost the same for all of the APs. Fig. 8 shows the results of 4 cases in this experiment. However, Fig. 8 appears to depict only one case because the results of the 4 cases are almost the same.

Finally, we arranged three laptops for connection to an AP. First, one of the laptops generated 2Mbps of traffic throughout the whole experiment. After 20 minutes the second laptop started to generate 2Mbps of traffic, and after another 20 minutes the third laptop did the same amount of work in sequence. We measured the variations in the network utilization of the AP and depicted them in Fig. 9. The measured utilization varied from 3.71%, 7.41%, and then 11.11 %, representing traffic loads of 2Mbps, 4Mbps and 6Mbps, respectively. So, one can make sure that the measured values are almost the same as the estimations given in Table 2.

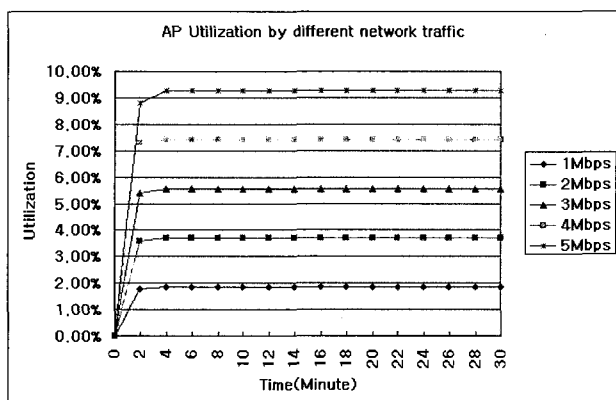

Fig. 7. Network utilizations by different network traffics

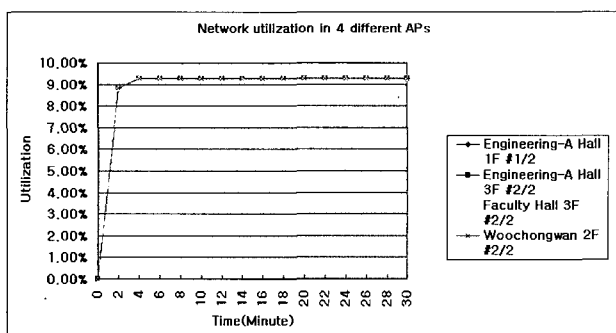

Fig. 8. Network utilizations in 4 different APs

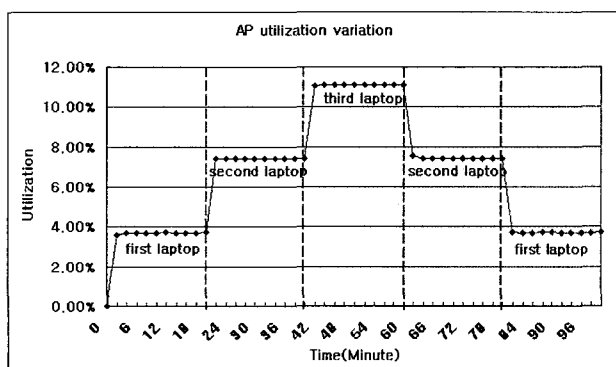

Fig. 9. Utilization variations

5. Conclusion

In this paper, we presented the design and implementation details of a system that was conceived to help mobile users to select the most competent AP by monitoring the network traffic of all the APs within a local LAN. As the key factors for mobile users when choosing a competent AP, the network utilization, location, and signal strength of the AP are provided in our system. We also verified the accuracy of monitoring and calculation of the AP utilization of the server through real experiments.

References

- [1] Access Point, http://en.wikipedia.org/wiki/Access_point
- [2] Tcpdump, <http://www.tcpdump.org>
- [3] SNMP Development, http://msdn.microsoft.com/library/default.asp?url=/library/en-us/snmp/snmp/snmp_start_page.asp
- [4] Diane Tang, Mary Baker, "Analysis of a Local-Area Wireless Network", in Mobicom 2000, p1-p10, August 2000.
- [5] David Kots Kobby Essien, "Analysis of a Campus-wide Wireless Network", in Mobicom 2002, p107-p118, September 2002.
- [6] Sungmin Baek et al., "Design and Implementation for Measurement System to Analyze Usage Pattern of Campus NESPOT Services", Korea Institute of Information and Telecommunication Facilities Engineering, August, 2004.
- [7] NDIS Developer's Reference, <http://www.ndis.com>
- [8] NDIS Protocol Driver, http://msdn.microsoft.com/library/default.asp?url=/library/en-us/NetXP_d/hh/NetXP_d/302pro_a648250f-4e5c-4140-bd7c-a1b8f3b7a154.xml.asp



Ji Yeon Park

Park received a BS degree in Computer Engineering from Hansung University in 2005. She is now undertaking a master's course as a member of the Mobile and Ubiquitous Computing Lab at Hansung University. Her research interests include mobile computing and ubiquitous computing.



Kitae Hwang

Hwang received a Ph.D. degree in Computer Engineering from Seoul National University in 1994, and has been a professor at Hansung University since 1994. His research interests are in the area of multimedia streaming, mobile computing, and ubiquitous computing.