

Space Charge Measurement as a Diagnostic Tool to Monitor Ageing in Polymeric Materials

George Chen^a

*School of Electronics and Computer Science, University of Southampton,
Southampton, UK*

^aE-mail : gc@ecs.soton.ac.uk

(Received October 12 2006, Accepted October 19 2006)

Charge dynamics in polymeric materials after aged under ac electric field using the pulsed electroacoustic (PEA) technique is reported. The emphasis is placed on charge decay. The charge dynamics of the ac aged additive free low density polyethylene (LDPE) samples under dc bias differ from the sample without ac ageing, indicating changes brought in by ac ageing. It is believed that a slow decay rate of charge in the ac aged sample is related to the formation of deep traps in the material. However, chemical analysis by infrared spectroscopy (FTIR) and Raman microscope reveals no significant chemical changes taken place in the bulk of the material after ac ageing. Further experiments on irradiated LDPE have revealed a similar behaviour, i.e. the charge decay is slower in irradiated samples than that of fresh sample. The findings presented clearly indicate that space charge measurement can be used as a diagnostic tool to monitor ageing in polymeric materials.

Keywords : Space charge, ac ageing, Trapping characteristics, Polymeric insulation, Irradiation, Diagnostic technique

1. INTRODUCTION

Space charge is a term used to describe the excessive charges in volume. Such excessive charges can be electrons, ions or mixture of both. In solid dielectrics space charge tends to build up at discontinuities, such as at the dielectric-electrode interface, at the grain boundaries in crystalline dielectrics, at the boundaries between crystalline and amorphous regions in semi-crystalline dielectrics, and at various molecular sites simply called charge traps. Under the influence of the electric field the trapped charges may begin to detrapp and move. The mechanism for charge formation could be either charge injection from electrodes or ionization of small molecules. Space charge phenomena have long been observed and their importance has been recognized over many years. In fact, space charge is recognized as a major factor in dielectric behavior, such as leakage, high-voltage reliability and dissipation factor. However, its role in dielectric ageing is still the subject of research. Researchers have shown a special interest in cross-linked polyethylene (XLPE) because of its widespread use as high voltage cable insulation in power transmission. Many efforts have been made to quantify charge in solid dielectrics with a various degree of success. Research on space charge in solid dielectrics

has been intensified in last two decades due to new development in non-intrusive measurement techniques.

In this paper, charge dynamics in polyethylene after either aged under ac electric field or irradiated by Gamma rays using the pulsed electroacoustic (PEA) technique is reported. The emphasis, however, is placed on charge decay.

2. EXPERIMENTAL DETAILS

2.1 PEA technique

The PEA technique is widely used to measure space charge in solid dielectric materials due to its simple in structure, low cost and easy to implement for both plaque and cable sample structures. The details of a PEA system can be found in literatures[1] and a schematic diagram is shown in Fig. 1.

In summary, acoustic waves are produced at charge layers at both electrodes and internal charge when an electrical pulse is applied to a sample. The acoustic signals are detected by a piezo-electric sensor. The profile obtained represents the charge distribution[1]:

$$V_s(t) = K[\sigma_1 + \sigma_2 + v_{sa}\Delta T\rho(x = v_{sa}t)]e_p \quad (1)$$

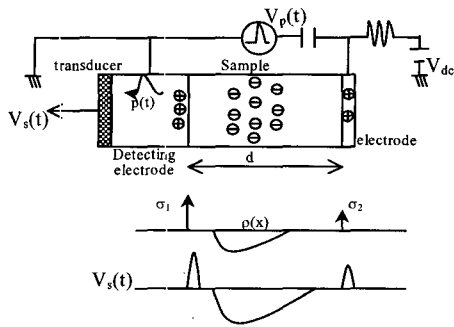

Fig. 1. Schematic diagram of PEA.

where σ_1 and σ_2 are the surface charges at the electrodes, v_{sa} the sound velocity through the material, ΔT the width of the pulse, ρ the bulk charge and e_p the amplitude of the pulse.

2.2 Sample details

LDPE was chosen because of its relatively simple chemical structure and its wide applications in cable insulation. Space charge formation in a material is greatly affected by the presence of impurities and additives as they can act either as ionisable centres under a high electric stress or as trapping sites. In order to reduce the influence of the impurities, additive-free low-density polyethylene (LDPE) was selected for the initial study. The thickness of the sample was typically either 100 or 200 μm thick. The diameter of the sample is 50 mm. Sufficient samples were prepared to eliminate the variation from batch to batch.

2.3 Ageing

AC electrical ageing was carried out at ambient temperature for various times at an applied electric stress of 50 kV/mm. In order to prevent from flashover the top brass electrode was cast in epoxy resin and the bottom electrode was semicon. The detailed arrangement can be found in the earlier paper[2].

The influence of irradiation on space charge decay was carried out on LDPE only. LDPE samples with 100 μm thick were cleaned with alcohol and subsequently placed in a ^{60}Co gamma source for irradiation to a dose of 100 kGy at a dose rate of approximately 1 kGy/h. Different batches of samples were irradiated at room temperature in ambient air, oxygen-free nitrogen. For irradiation in nitrogen, the samples were placed inside glass tubes which were evacuated for several hours before being backfilled with nitrogen gas and sealed. Irradiation was carried out at ambient temperature.

2.4 Chemical analysis on ac aged LDPE

It is well known that long term ageing can cause chemical changes which subsequently deteriorate

electrical performance of the material. High electric stress can accelerate processes of deterioration. Infrared (IR) and Raman spectra are very sensitive to the chemical changes. They have been used extensively to examine chemical changes caused by electrical ageing. In the present study, these techniques have been used to monitor any chemical changes taken place in the aged sample.

3. RESULTS AND DISCUSSION

3.1 Space charge characteristics in ac aged LDPE under dc voltage

In order to explore the possible effect brought in during the ac ageing, space charge dynamic characteristics under dc stress were investigated. Sample was aged at an ac electric stress of 50 kV/mm (50 Hz) with brass and semicon electrodes for 40 hrs before it was removed from ac ageing for dc stressing. The same dc stress level as ac ageing stress, i.e. 50 kV/mm was applied to the aged sample. For comparison reason, charge dynamics in an unaged sample were also measured. Both charge accumulation during stressing and charge decay after the removal of dc stress were monitored. However, only charge profiles after the removal of the applied voltage are shown in this paper. The electrodes used for applying dc were semicon as the anode and aluminium as the cathode.

Figure 2 shows the changes in charge distribution after 4 hrs dc stressing in ac aged sample. It can be seen that the charge formed during dc stressing is very stable. On the other hand, the charge in the unaged sample under the same dc stressing condition shows remarkable difference as shown in Fig. 3.

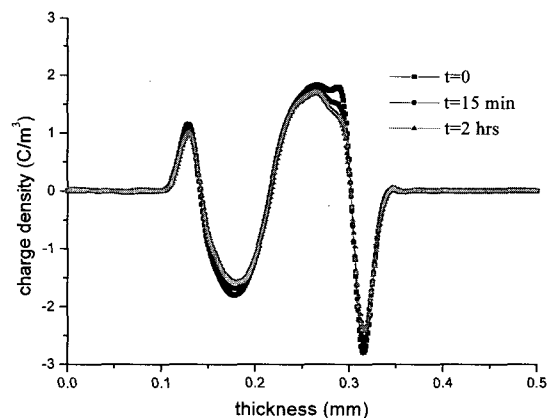

Fig. 2. Charge profiles in ac aged LDPE after the removal of 50 kV/mm dc electric stress.

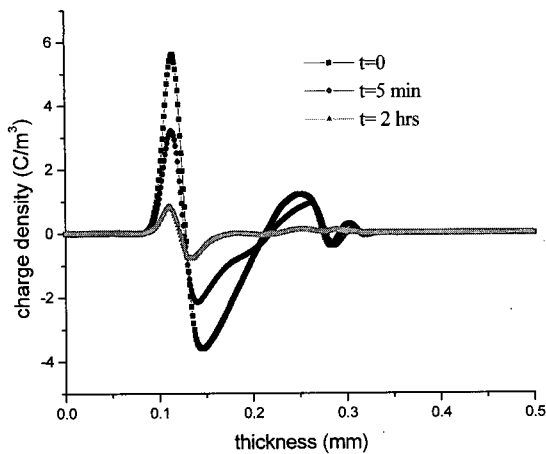

Fig. 3. Charge profiles in unaged LDPE after the removal of 50 kV/mm dc electric stress.

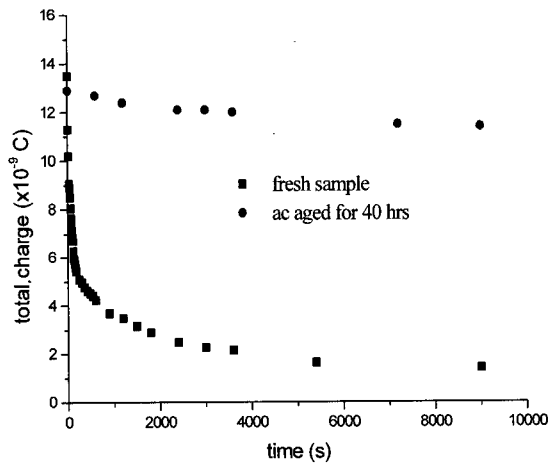

Fig. 4. Charge decay in unaged and ac aged LDPE after the removal of 50 kV/mm dc electric stress.

It was noticed that the charge dynamics during stressing period were complex and there was significant change in charge distribution during the application of dc voltage. The detailed analysis of the results is in itself a separated issue and will not be presented here. The characteristics of the amount of charge formed in the bulk in the aged and unaged samples are very different, leading to different charge distributions (curves at $t=0$ in Figs. 3 and 4).

The total amount of charge as a function of time after the removal of the applied dc stress is shown in Fig. 4. There is a distinct difference in charge decay for aged and unaged samples. For aged sample the amount of charge remains unchanged over a long period time while for unaged sample there is a significant decrease in first 15 minutes followed by a slow decay. The final amount of charge after 3 hrs decay indicates much less charge presence in the unaged sample.

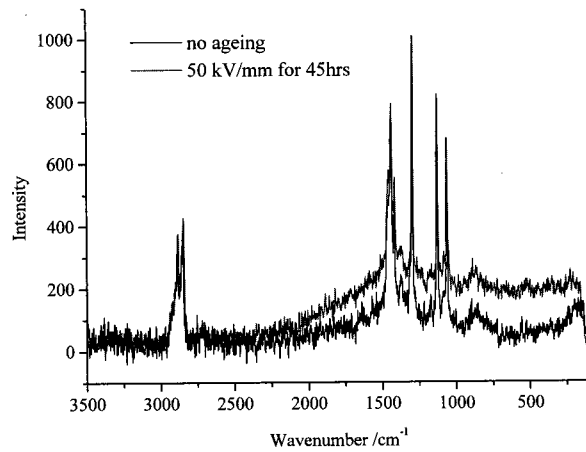

Fig. 5. Raman spectra of ac aged LDPE.

3.2 Chemical analysis on ac aged LDPE

Under the influence of electric stress, chemical changes may take place. Both infrared (IR) and Raman spectra have been used to measure chemical changes in LDPE. There is no significant change in IR spectra therefore not shown here. Fig. 5 depicts the Raman spectra of LDPE prior to and after ac ageing tests.

There is no significant changes occurred in the sample aged for 45 hours. The possible explanation is that the period of stressing time is too short. However, in Raman spectra before and after ageing, there is a slightly rise in background which is caused by fluorescence. Recent investigation into electrical tree in polyethylene[3] reveals that the fluorescence is due to partial degradation of the polymer. It must be stated that the rise in background is no way near to those observed in a treeing region.

3.3 Influence of gamma irradiation

Charge dynamics after the removal of the applied voltage is shown in Fig. 6.

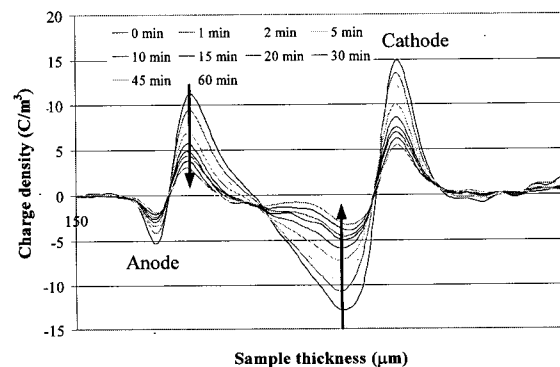

Fig. 6. Charge decay dynamics in control sample after the removal of the applied voltage.

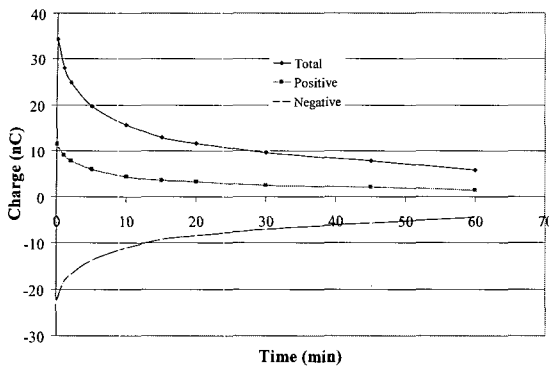

Fig. 7. Charge decay in control sample after being stressed at 50 kV/mm for 60 minutes.

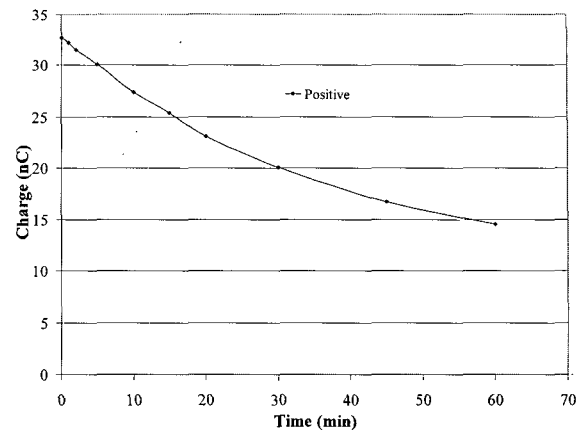

Fig. 9. Charge decay in 100 kGy irradiated sample after being stressed at 50 kV/mm for 60 minutes.

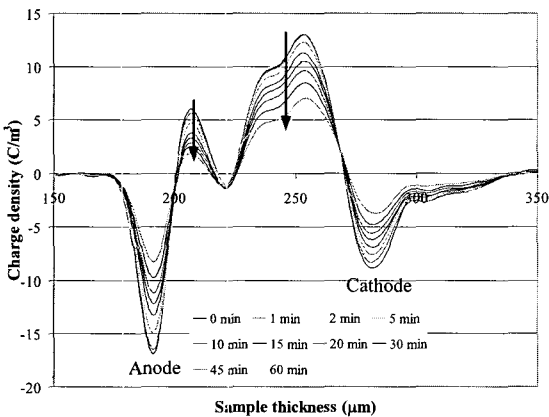

Fig. 8. Charge decay dynamics in 100 kGy irradiated sample after the removal of the applied voltage.

Generally charge decays fairly fast and significant reduction in bulk charge is observed. Another feature is the charge distribution maintains a similar shape. Under the influence of its own field, charge could either leak out from electrodes or recombine. The amount of charge in the bulk can be estimated using the following equation:

$$Q = \int_0^d |\rho(x)| \cdot S \cdot dx \quad (2)$$

where $\rho(x)$ is charge density, S the electrode area and d the thickness of the sample. Both positive and negative charge can also be calculated. Charge decays for total, positive and negative charges in the bulk are shown in Fig. 7. As expected from Fig. 6, charge decays fairly fast, indicating the presence of shallow traps.

Charge decay dynamics in 100 kGy irradiated sample are shown in Fig. 8. In addition to positive charge adjacent to the anode present in all cases, there is a considerable amount of positive charge adjacent to the

cathode. In considering this situation it must be borne in mind that while the majority of electrons from ion-pair production are geminate, in that they remain within the sphere of the influence of their parent ions, some are non-geminate and are free to move around in the material by means of thermal excitation and/or the action of an electric stress. In these circumstances trapping and detrapping will play an important role in the population dynamics. In the particular case of the results of Fig. 8 it would appear that electrons have been swept by the electric field towards the anode and left the more massive and less mobile positive ions at the cathode. There is a small amount negative charge present between the positive charge regions and they are fairly stable.

The less mobile charge should be reflected in charge decay with time as shown in Fig. 9. A slow decay in positive charge is observed. It is believed that electrons are injected from the electrodes to neutralize positive ions.

Ionisation of the material gives rise to radicals and to the subsequent alteration of the structure of the material via chemical radical reactions and the mechanisms of cross-linking, chain scission, gas production and oxidation cited earlier[5]. Thus as well as releasing charge within the material, radiation causes it to change from its original state. This happens not only as irradiation takes place, but also afterwards as oxygen, for example, diffuses into the bulk and produces oxidation products such as ketones, alcohols and hydroperoxides among many others, depending on the material in question. In the presence of oxygen, one oxidation product that is readily observable with irradiated LDPE is the carbonyl group ($C=O$). It is well established that the concentration of carbonyl groups increases with radiation dose and that the carbonyl groups generate a shallow trap that readily assists charge transport[6].

Table 1. Remaining charge in irradiated LDPE.

Sample	positive	negative	total
fresh	12.1 %	19.5 %	17 %
100 kGy in air	44.3 %		44.3 %
100 kGy in N ₂		56.4 %	56.4 %

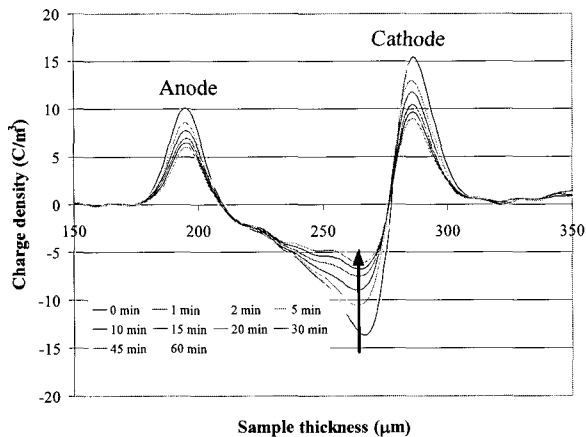

Fig. 10. Charge decay dynamics in 100 kGy irradiated sample in nitrogen gas.

Figure 10 shows the charge distribution in the sample exposed to 100 kGy in nitrogen gas at a stress of 50 kV/mm. Only negative charges were observed at the end of stressing period. As negative charge peak is adjacent to the cathode, negative charges are believed to be injected from the cathode. Charge decay rate is slower compared to the control sample as shown in Fig. 11. The difference in charge distribution among irradiated in air and nitrogen gas may indicate different chemical changes induced by irradiation.

In the absence of oxygen, LDPE undergoes predominantly cross-linking under irradiation. The results suggest that the cross-linking by irradiation have major effect on charge decay.

There are marked differences between the space charge characteristics of material irradiated in air in comparison with LDPE irradiated in oxygen-free nitrogen gas. The percentage of remaining charge in LDPE after 1 hour decay is estimated and summarized in Table 1.

The charge decay rate in irradiated samples is significantly slower than that of fresh sample. The difference among the irradiated sample may further reflect different changes brought in by irradiation environments, i.e. the manner in which space charge distributions vary with irradiation environments is clearly a function of the structural changes taking place within the LDPE.

More importantly, the results clearly demonstrate that space charge is a good tool to monitor changes caused by irradiation.

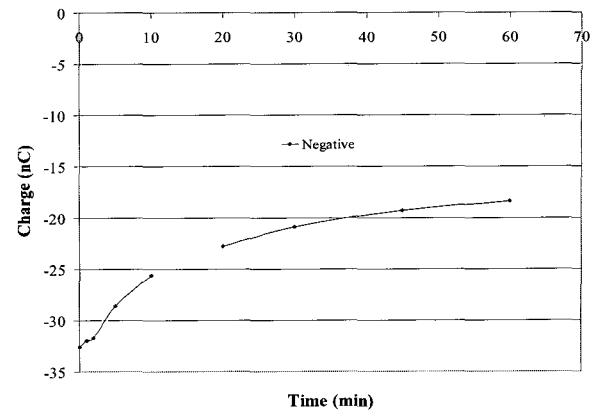

Fig. 11. Charge decay in 100 kGy irradiated sample after being stressed at 50 kV/mm for 60 minutes.

4. CONCLUSION

In this paper we present changes in space charge behaviours of both ac electrically aged and gamma irradiated additive-free low density polyethylene. The results clearly illustrate different characteristics of space charge in aged and unaged samples. Charge decay rate in aged samples, regardless of electrical or irradiation ageing, is much slower than that of unaged samples. The results demonstrate that space charge measurement is a very sensitive technique to monitor degradation of polymeric materials. Compared with the conventional methods, it seems that space charge technique is more sensitive to the change in physical structure/chemical alternation due to electric stressing or irradiation.

REFERENCES

- [1] Y. Li, M. Yasuda, and T. Takada, "Pulsed electro-acoustic method for measurement of charge accumulation in solid dielectrics", *IEEE Trans. Diel. Electr. Insul.*, Vol. 1, p. 188, 1994.
- [2] G. Chen, M. Fu, X. Z. Liu, and L. S. Zhong, "Ac Ageing and space charge characteristics in low density polyethylene *Polymeric Insulation*", *J. Applied Physics*, Vol. 97, No. 6, 2005.
- [3] A. S. Vaughan, S. J. Dodd, and S. J. Simon, "A Raman microscope study of electrical treeing in polyethylene", *J. Mater. Sci.*, Vol. 39, p. 181, 2004.
- [4] Mazzanti G., Montanari G. C., and Palmieri F., "Quantities extracted from space-charge measurement as markers for insulation ageing", *IEEE Trans. DEI*, Vol. 10, p. 108, 2003.
- [5] A. Charlesby, "Atomic Radiation and Polymers", Pergamon, New York, 1960.
- [6] Y. Takai, K. Mori, T. Mizutani, and M. Ieda, "Investigation of traps in gamma-irradiated polyethylene by photostimulated detrapping current analysis", *Jpn. J. Appl. Phys.*, Vol. 15, p. 2341, 1976.