

IT839

A Development Direction of Information Security Technology for IT839 Strategies

(D.I. Seo)
(K.S. Kim)
(J.S. Jang)
(S.W. Sohn)

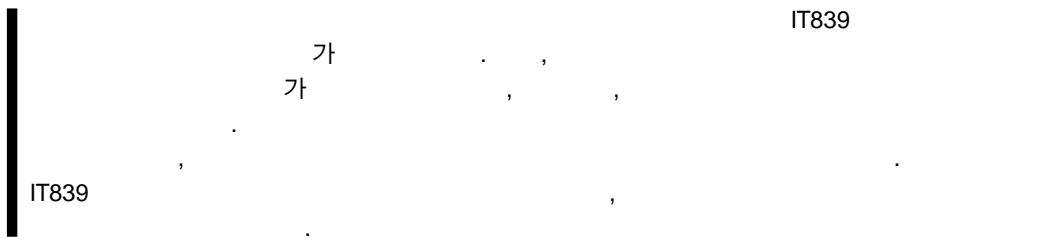

I.

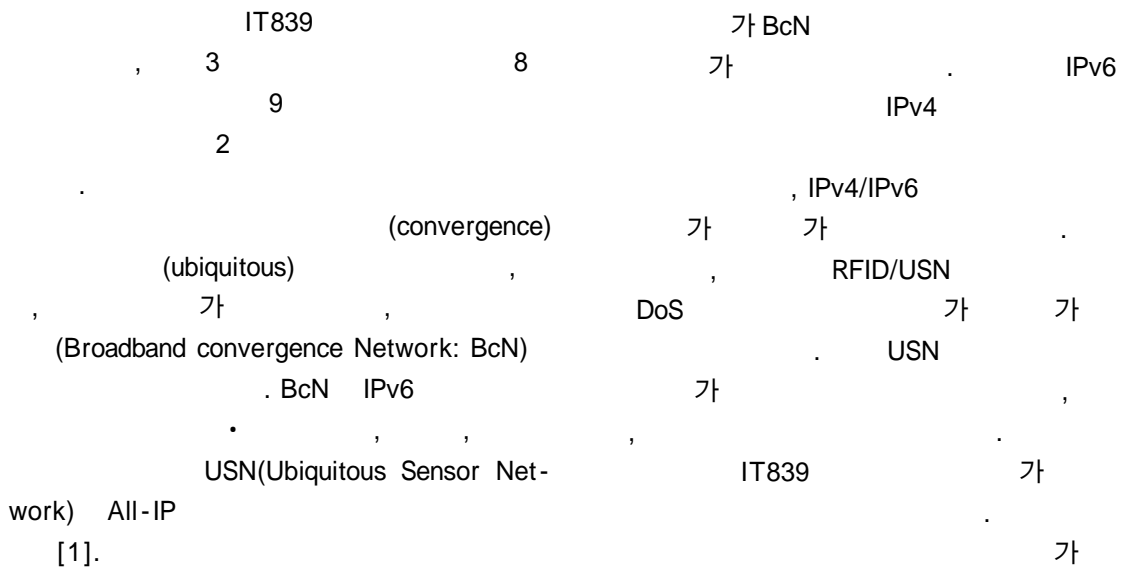

IT839

가

IT SoC

가

BcN

IPv6

IPv6

가

가

가

USN

IT839

USN

가

IT839

IT

IP(Intellectual Prop-

erty)

2.

II.

(1)

IT839

2003 225

가 (CAGR) 19.1%

2007

454

[2]. (

ID/VA, 3A, SCM, /VPN, /VPN, NIDS,

가, IP VPN

1.

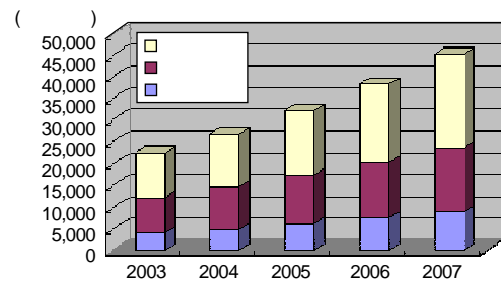

(Privacy Enhancing Technologies: PETs)

< >: IDC, Worldwide IT Security and Business Continuity Forecast, 2003. 9.

(1)

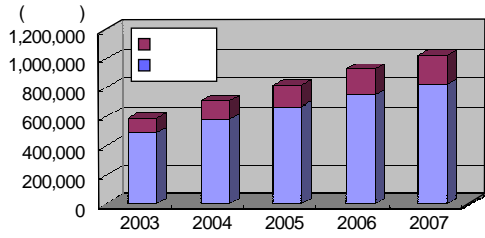

(European Network and Information Security Agency: ENISA)

2003 10

< >: KISA, , 2003. 9.

(2)

가

(2)

u-Korea

2003 5,861

CAGR 16.8%

2007 1 300

가

[3].

PKI

4.

가

RFID/USN

, IPv4/

IPv6

IT

가

DRM(Digital Rights Management)

IP

가

3.

, 9.11

가

(DHS)

5

가

, EU

2003 1.25

가 , ,

< 1>

, IT839

2.5 75%

가

ETRI 2003 11 29 28

가 136

BcN

, 가 가

[4].



< 1>

		가	()	(%)
		- /	2	80
		-	2	70
		-	2	80
		-	1	85
	BcN/IPv6	- 가	3	75
	USN	-	2.5	80
		-	2	80
		-	1	85
	IT	-	2	80
		-	2	75
		-	1	85
		-	2	80
	T-Commerce	-	3	70

III. [5],[6]

IT839 가
 IT839 /
 , e-ID
 BcN,
 IPv6, USN
 IT ID
 가 SSO(Single Sign On),
 ID , ID
 가 (3)
 , (4)
 0.01%
 1. 가

IT839

Security : U-Secure, U-Clean, U-Privacy KOREA	
	2004 2005 2006 2007 2008 2010 2013
/	 <p style="text-align: right;">SoC</p>
	<p>Integrated Security Fusion Security Intelligent Security</p>
	
	<p>Global PKI, PMI IC +</p>
	<p>USN PKI USN / USN USN</p>
	<p>IP/SoC IP/SoC IP/SoC IP/SoC</p> <p>IP/SoC IP/SoC</p> <p>IP/SoC IP/SoC</p> <p>/</p>

(3)

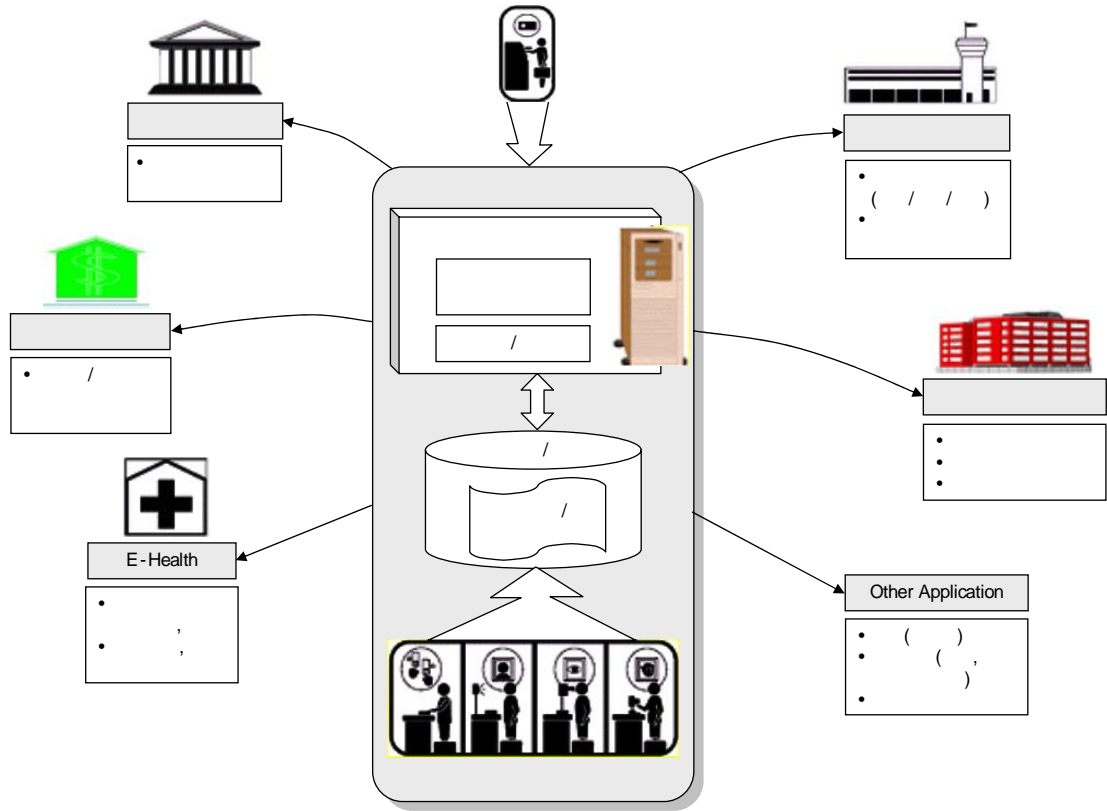

(4)

가

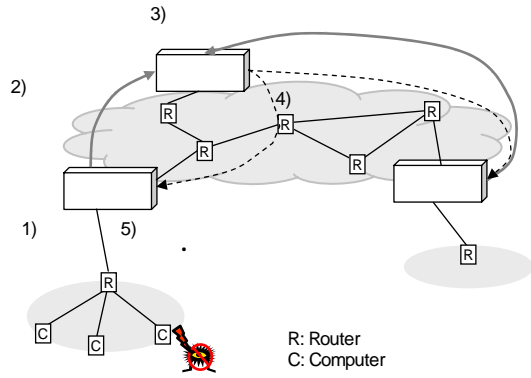

(5)

2.

BcN, IPv6, USN

, IPv6

2003 1.25

(5)

BcN
/ /

6

IT

IPv6
Peer)

P2P(Peer-to-

IT

IPv6

. RFID/USN

3.

IT

IV.

(6)

PC

가

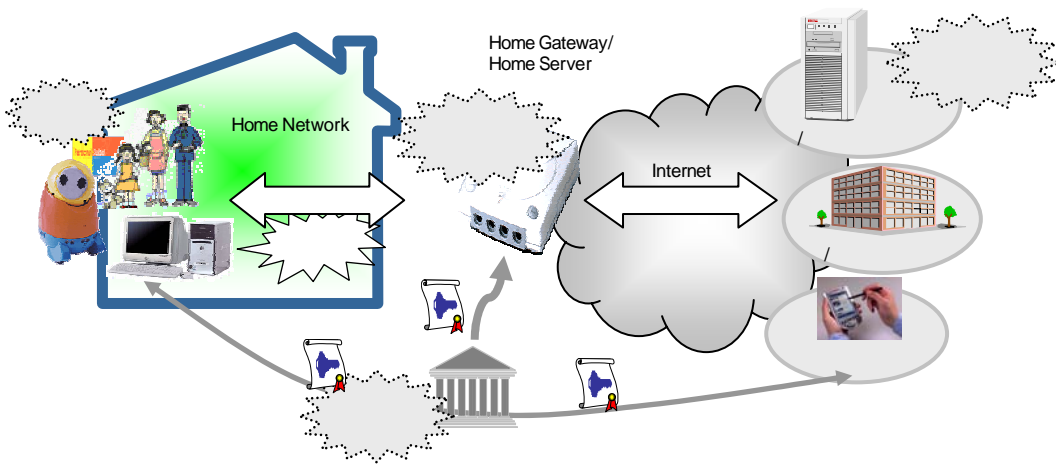

(6)

IT839

가

2010

IT839

- [1] , "IT839 - BcN," 2004. 6.
- [2] IDC, Worldwide IT Security and Business Continuity Forecast, 2003. 9.
- [3] (KISA), " , " 2003. 12. 13.
- [4] (ETRI) , " , " 2004. 1.
- [5] , "IT839 , " ETRI CEO Information 17 , 2004. 11. 17.
- [6] , " () , " 2004. 12. 6.