

# On the Motion of the Structure Varying Multibody Systems with Two-Dimensional Dry Friction

Fujie Xia\*

Faculty of Engineering and Physical Systems,  
Central Queensland University, Rockhampton QLD 4702, Australia

Peter Wolfs, Colin Cole

Faculty of Engineering and Physical Systems,  
Central Queensland University, Rockhampton QLD 4702, Australia

In the present paper the dynamics of the structure varying multibody systems caused by stick-slip motion with two-dimensional dry friction are analyzed. The methods to determine friction force both in stick and slip states are described. The direct method of considering the wagon bogie system as a structure varying system was used to consider two dimensional friction at the wheelset-side frame connection. The concept of friction direction angle used to determine the friction force components of two-dimensional dry friction both in the stick and slip motion states was used. A speed depended friction coefficient was used and described approximately by hyperbolic secant function. All switch conditions were derived and friction forces both for stick and slip states. Some simulation results are provided.

**Key Words :** Multibody System, Dry Friction, Structure Varying, Stick and Slip

## 1. Introduction

Among mechanical systems there exist some systems of which the degrees of the freedom will vary with the change of the acting dry friction force vector. A simple such system as Fig. 1 shows, mass 2 is on the mass1 and exciting forces  $F_1$  on  $m_1$  and exciting force  $F_2$  on  $m_2$ . The motions of mass 1 and mass 2 have two states : stick together and slip against each other. The stick motion means that the relative velocity  $V_r = \dot{x}_1 - \dot{x}_2 = 0$  and vice versa. For the stick motion the two masses move together the number of degrees of freedom of the system is one ; and for the slip

motion the number of degrees of freedom of the system become two. The system is therefore called a structure varying system due to friction between two masses. The dynamic system is a discontinuous system.

In the investigation on the dynamics of a railway wagon bogie the two dimensional dry friction exists on the surfaces of a side frame con-

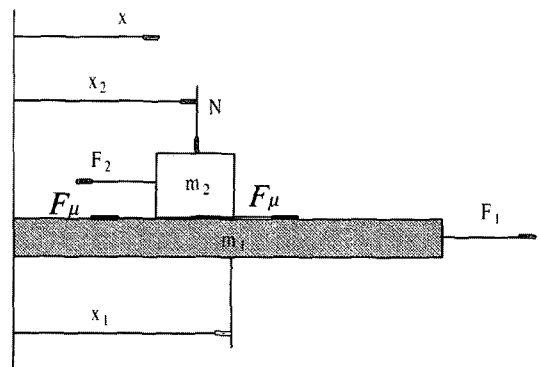

Fig. 1 A simple structure varying system

\* Corresponding Author,  
E-mail : f.xia@cqu.edu.au  
TEL : +61-7-4930-9035; FAX : +61-7-4930-6984  
Faculty of Engineering and Physical Systems, Central Queensland University, Rockhampton QLD 4702, Australia. (Manuscript Received November 29, 2004; Revised December 15, 2004)

tacting two wheelset axle in the longitudinal and lateral directions as shown in Fig. 2. Because of the effect of the dry friction the stick-slip motions between the side frames and wheelsets will take place. As a consequence, the degrees of freedom of the system will vary according to the different motion modes. For example, when the relative velocity between a frame and a wheelset is equal to zero then the frame and the wheelset on the contact surface will move as one body both in the longitudinal and lateral directions. These structure varying systems can also be found in other mechanical systems. In the previous investigation by the first author (Xia, 2002), friction direction angle is introduced to determine the friction force components. The angle plays a decisive role in the analysis of the structure varying system.

The friction coefficient may be determined using Coulomb law, a static-dynamic friction model or relative velocity-dependent friction models which can be described with various approximate formulae. In our studies in order to use one formula to replace all the friction models we provide an approximate relation using the hyperbolic secant function to describe the velocity-dependent friction coefficient. By selection of different values of only one parameter the formula yields different steepness of the continuous curve that describes

the change from the static to the kinematical friction coefficient.

## 2. Methods to Determine Friction Force Both in Stick and Slip States

To describe the structure varying system caused by friction the key point is to determine the friction force both in stick and slip states. There are two methods to deal with the stick-slip motion caused by dry friction: one is the so called direct method in which switch conditions are used to control the motion states and the other one is by introducing a dry friction element which consists of a Coulomb friction calculator in series with a spring. The friction force in stick state can be approximately determined from the spring degree of freedom. A suitable stiffness must be selected to get acceptable simulation accuracy.

The friction element used in Vampire is described as shown in Fig. 3, (Vampire, 2002). The friction force is measured by relative displacement of the stiffness  $k_1$  both for stick and slip state. If the spring force larger than the static friction force  $F_{n}\mu_s$  and the relative velocity is from zero the acting friction force  $F_{ut} = F_n\mu_h$ ; otherwise the acting friction force equals the spring force. This friction element is suitable to the case where there is only dry friction connection between two relative movable bodies. This approach also has the following shortcomings.

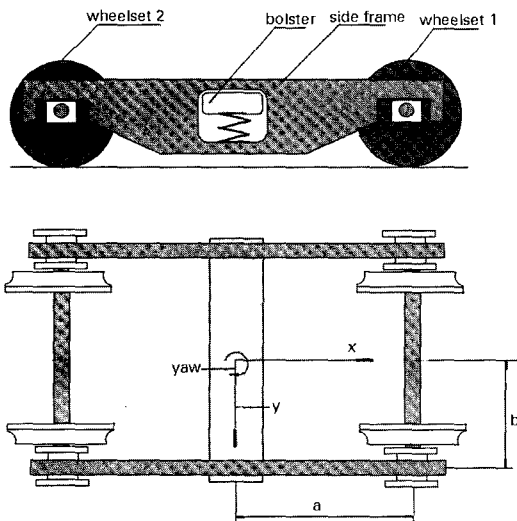

Fig. 2 The wagon bogie system

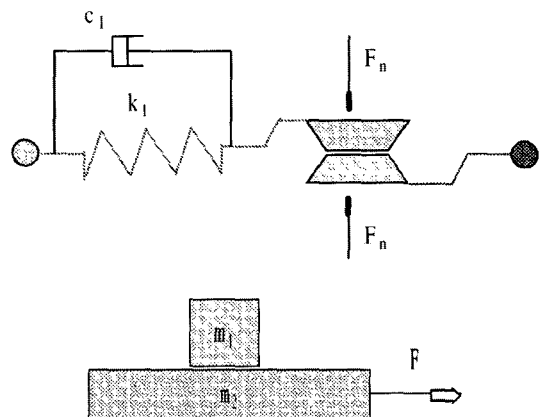

Fig. 3 Friction element used in Vampire

The first is that during stick mode the relative displacement between the two bodies is exactly zero, but in this friction element the stiffness is introduced to create a non-zero relative displacement between the two bodies through a suitably large stiffness element.

The second is that the viscous damping added to this friction element may not actually be there. The reason it added is that during stuck mode the relative velocity between the two bodies is zero.

Finally, the stiffness element must be selected to give suitable result, that means not small and not large. For a small value the relative displacement will be too large to be accepted for the practical case; for a large value high frequency noise will be introduced to the simulation. To show this a friction element of this type is applied to the system in Fig. 3. The friction force both in stick and slip states are shown in Fig. 4, where the parameters are:  $F_n=1\text{ N}$ ,  $\mu_s=\mu_k=0.4$ .  $m_1=m_2=1\text{ kg}$ ,  $g=1\text{ m/s}^2$ ,  $k_1=5E4\text{ N/M}$ .

Note the high frequency vibration in the stick mode regions.

The second friction element was originally developed by Kolsch and implemented into the ADAMS/Rail later (Adams/Rail, 2002). The principle of this method is described in Fig. 5. The results are shown in Fig. 6.

The force between the body 1 and body 2 is defined as :

$$F = K_0 \Delta d + F_{k1} \tag{1}$$

where  $\Delta d$  denotes the relative displacement between the two bodies and  $F_{k1}$  is defined as :

$$\dot{F}_{k1} = K_1 \Delta V \left\{ 1 - 0.5 \left( 1 + \text{sign}(\Delta V \times F_{k1}) \right) \left| \frac{F_{k1}}{H_1} \right|^m \right\} \tag{2}$$

where  $\Delta V$  denotes the relative velocity between the two bodies;  $H_1$  denotes the maximal static friction force and is the exponent of the transition.

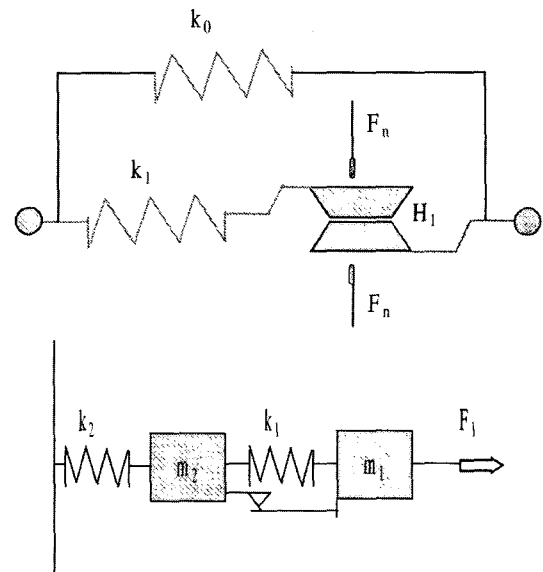

Fig. 5 Friction element used in ADAMS/RAIL

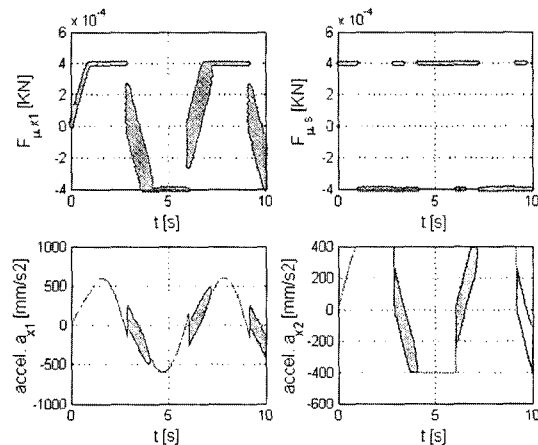

Fig. 4 Friction force from friction element used in Vampire

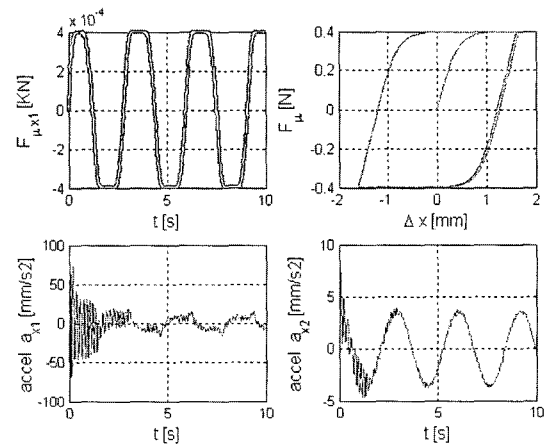

Fig. 6 Friction force from friction element introduced in ADAMS/RAIL

This method is more accurate than the first one for the friction force calculation during stick mode but it cannot be used to describe the case where there is only dry friction connection between two relative movable bodies. The obvious reason is that the parallel stiffness  $k_0$  limits the free relative motion between the two contacting bodies in the  $x$  direction. The Adams/Rail friction element can better describe the case where there is a spring connection between the two bodies. In that case the friction element gives a better approximate stick friction force, where the parameters are:  $F_n=1\text{ N}$ ,  $\mu_s=\mu_k=0.4$ ,  $m_1=m_2=1\text{ kg}$ ,  $g=1\text{ m/s}^2$ ,  $k_1=5E4\text{ N/m}$ .

For the direct method we take the system shown in Fig. 1 as an example, for the slip motion the friction force is determined by

$$F_{\mu k} = N\mu_k \text{sign}(\dot{x}_1 - \dot{x}_2) \quad (3)$$

In that case the system has two degrees of freedom. For the stick motion, that is, the relative velocity between  $m_1$  and  $m_2$  is zero, the friction force is then determined by (Xia, 2002)

$$F_{\mu s} = \frac{1}{m_1 + m_2} [m_2 F_1 + m_1 F_2] \quad (4)$$

The system has one degree of freedom during the stick motion process. And the switch conditions to control the motion from stick to slip are

$$\begin{aligned} \dot{x}_1 - \dot{x}_2 &= 0 \\ (m_2 F_1 + m_1 F_2) &\leq (m_1 + m_2) N\mu_s \end{aligned} \quad (5)$$

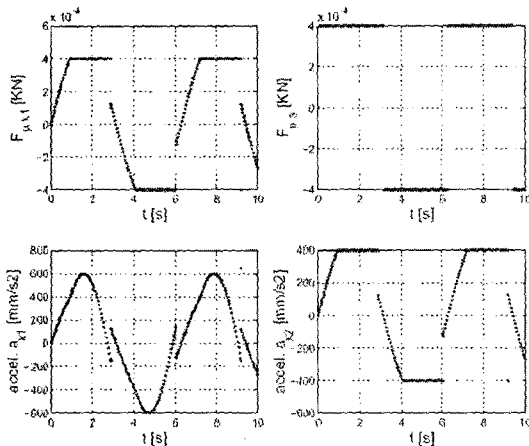

Fig. 7 Friction forces and accelerations

If the above conditions are met the motion of the system is stuck, and vice versa. By this method the friction force between two bodies of Figure 1 is shown in Figure 7, where the parameters are:  $N=1\text{ N}$ ,  $\mu_s=\mu_k=0.4$ ,  $m_1=m_2=1\text{ kg}$ ,  $g=1\text{ m/s}^2$ ,  $F_1=\sin(t)$ ,  $F_2=0$ .

After the determination of the acting friction forces both for the stick and slip states the discontinuous dynamic system can be transformed into a piece-wise differentiable system. The number of degrees of freedom will therefore change automatically as the simulation progresses.

### 3. The Modelling of a Wagon Bogie

The ways to determine the friction forces discussed above are only for the one-dimensional friction case. For the two-dimensional friction case friction force components determination become more complex (Xia, 2002). Though there is a two-dimensional friction element that can be used in Vampire but analysis is difficult as the friction force can not be displayed as an output in an simple system by the software. There is no two-dimensional friction element in Adams/Rail. To model the motions of the wagon bogie the two-dimensional friction needs to be considered. Here direction method will be used. The equations for the bogie system as shown in Fig. 8

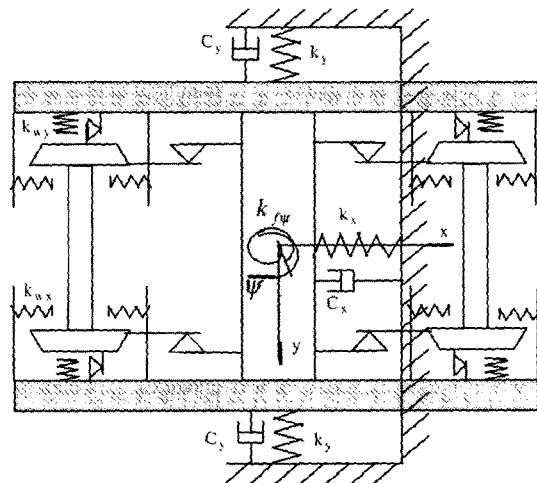

Fig. 8 Wagon bogie model

can be written below.

For frame

$$m_f \ddot{x}_f = F_{\mu w1xl} + F_{\mu w1xr} + F_{\mu w2xl} + F_{\mu w2xr} - F_{kfx} + F_{kwx} \quad (6)$$

$$m_f \ddot{y}_f = F_{\mu w1yl} + F_{\mu w1yr} + F_{\mu w2yl} + F_{\mu w2yr} - F_{kfy} + F_{kwy} \quad (7)$$

$$I_f \ddot{\psi}_f = M_{\mu wx} + M_{\mu wy} - F_{k\psi} + M_{kwx} + M_{kwy} \quad (8)$$

where

$$F_{kwx} = F_{kw1xl} + F_{kw1xr} + F_{kw2xl} + F_{kw2xr} \quad (9)$$

$$F_{kwy} = F_{kw1yl} + F_{kw1yr} + F_{kw2yl} + F_{kw2yr}$$

and

$$M_{\mu wx} = b(F_{\mu w1xl} - F_{\mu w1xr} + F_{\mu w2xl} - F_{\mu w2xr})$$

$$M_{\mu wy} = a(F_{\mu w1yl} + F_{\mu w1yr} - F_{\mu w2yl} - F_{\mu w2yr}) \quad (10)$$

$$M_{kwx} = a(F_{kw1xl} - F_{kw1xr} + F_{kw2xl} - F_{kw2xr})$$

and for the front wheelset

$$m_w \ddot{x}_{w1} = F_{w1x} - F_{\mu w1xl} - F_{\mu w1xr} - F_{kw1xl} - F_{kw1xr} \quad (11)$$

$$m_w \ddot{y}_{w1} = F_{w1y} - F_{\mu w1yl} - F_{\mu w1yr} - F_{kw1yl} - F_{kw1yr} \quad (12)$$

$$I_w \ddot{\psi}_{w1} = M_{w1\psi} - b(F_{\mu w1xl} - F_{\mu w1xr}) - b(F_{kw1xl} - F_{kw1xr}) \quad (13)$$

and for the rear wheelset

$$m_w \ddot{x}_{w2} = F_{w2x} - F_{\mu w2xl} - F_{\mu w2xr} - F_{kw2xl} - F_{kw2xr} \quad (14)$$

$$m_w \ddot{y}_{w2} = F_{w2y} - F_{\mu w2yl} - F_{\mu w2yr} - F_{kw2yl} - F_{kw2yr} \quad (15)$$

$$I_w \ddot{\psi}_{w2} = M_{w2\psi} - b(F_{\mu w2xl} - F_{\mu w2xr}) - b(F_{kw2xl} - F_{kw2xr}) \quad (16)$$

where  $F_{w1x}$ ,  $F_{w1y}$ ,  $F_{w2x}$ ,  $F_{w2y}$ ,  $M_{w1}$ ,  $M_{w2}$  denote the forces acting on the corresponding wheelsets which can be considered as wheel/rail contacting forces.  $F_{\mu w1xl}$ ,  $F_{\mu w1xr}$ , ... denote the friction forces on the surfaces of frames and wheelsets (adapters).  $F_{kfx}$ ,  $F_{kfy}$ ,  $F_{k\psi}$  are the spring forces between car body and frames. And  $F_{kw1xl}$ ,  $F_{kw1xr}$ , ... denote the dead band stop forces between frame and wheelsets.

Spring forces are introduced to describe the impact forces that occur between side frames and wheelsets as the clearances limits. The stiffness  $K$  is for all cases.

The motions of the system may be divided into slip motion and stick motion. In the case of the slip motion the friction forces on the contact

surfaces between side frames and wheelsets can be determined by the method described in (Xia, 2003) as :

$$F_{\mu wixi} = m_f g \mu_k \cos \theta_i \quad (17)$$

$$F_{\mu wivi} = m_f g \mu_k \sin \theta_i$$

where  $\theta$  denotes the friction direction angle which described in (Xia, 2003).

Obviously the independent degrees of freedom of the system are seven for the slip motion state.

For the stick motion, one way to approach this problem is to use the friction element which is described in Figure 5 to determine the friction force approximately. This approach fails because there is only dry friction between a side frame and wheelset. Another method is direct method described in (Eich-Soellner and F  hrer, 1998) (Xia, 2002). Firstly, switch conditions are needed and can be written out as :

$$V_{fw1x} = \dot{x}_{w1} - \dot{x}_f = 0$$

$$V_{fw1\psi} = \dot{\psi}_{w1} - \dot{\psi}_f = 0$$

$$V_{fw1y} = \dot{y}_{w1} - \dot{y}_f - a\dot{\psi}_f = 0 \quad (18)$$

$$V_{fw2x} = \dot{x}_{w2} - \dot{x}_f = 0$$

$$V_{fw2y} = \dot{y}_{w2} - \dot{y}_f + a\dot{\psi}_f = 0$$

$$V_{fw2\psi} = \dot{\psi}_{w2} - \dot{\psi}_f = 0$$

and

$$F_{\mu tw1x} \leq F_{\mu sw1x}, F_{\mu tw1\psi} \leq F_{\mu sw1\psi}, F_{\mu tw1y} \leq F_{\mu sw1y} \quad (19)$$

$$F_{\mu tw2x} \leq F_{\mu sw2x}, F_{\mu tw2y} \leq F_{\mu sw2y}, F_{\mu tw2\psi} \leq F_{\mu sw2\psi}$$

where

$$F_{\mu tw1x} = \frac{F_{w1x} - F_{kw1xl} - F_{kw1xr}}{m_w} + \frac{F_{kfx}}{m_f} - \frac{F_{kwx}}{m_f}$$

$$F_{\mu sw1x} = \frac{m_f g \mu_s}{4m_w} [\cos \theta_{w1l} + \cos \theta_{w1r}] + \frac{g \mu_s}{4} [\cos \theta_{w1l} + \cos \theta_{w1r} + \cos \theta_{w2l} + \cos \theta_{w2r}] \quad (20)$$

$$F_{\mu tw2x} = \frac{F_{w2x} - F_{kw2xl} - F_{kw2xr}}{m_w} + \frac{F_{kfx}}{m_f} - \frac{F_{kwx}}{m_f}$$

$$F_{\mu sw2x} = \frac{m_f g \mu_s}{4m_w} [\cos \theta_{w2l} + \cos \theta_{w2r}] + \frac{g \mu_s}{4} [\cos \theta_{w1l} + \cos \theta_{w1r} + \cos \theta_{w2l} + \cos \theta_{w2r}] \quad (21)$$

$$F_{\mu tw1\psi} = \frac{M_{w1\psi}}{I_w} - \frac{b}{I_w} [F_{kw1xl} - F_{kw1xr}] + \frac{b}{I_f} F_{k\psi} - \frac{M_{kwy}}{I_f} - \frac{M_{kwx}}{I_f} \quad (22)$$

$$F_{\mu sw1\psi} = \frac{m_f g \mu_s b}{4I_w} [\cos \theta_{w1l} - \cos \theta_{w1r}] + \frac{m_f g \mu_s a}{4I_f} [\sin \theta_{w1l} + \sin \theta_{w1r} - \sin \theta_{w2l} - \sin \theta_{w2r}] + \frac{m_f g \mu_s b}{4I_f} [\cos \theta_{w1l} - \cos \theta_{w1r} + \cos \theta_{w2l} - \cos \theta_{w2r}]$$

$$F_{\mu tw2\psi} = \frac{M_{w2\psi}}{I_w} - \frac{b}{I_f} [F_{kw2xl} - F_{kw2xr}] + \frac{b}{I_f} F_{k\psi} - \frac{M_{kwy}}{I_f} - \frac{M_{kwx}}{I_f} \quad (23)$$

$$F_{\mu sw2\psi} = \frac{m_f g \mu_s b}{4I_w} [\cos \theta_{w1l} - \cos \theta_{w1r}] + \frac{m_f g \mu_s a}{4I_f} [\sin \theta_{w1l} + \sin \theta_{w1r} - \sin \theta_{w2l} - \sin \theta_{w2r}] + \frac{m_f g \mu_s b}{4I_f} [\cos \theta_{w1l} - \cos \theta_{w1r} + \cos \theta_{w2l} - \cos \theta_{w2r}]$$

$$F_{\mu w1y} = \frac{(F_{w1y} - F_{kw1yl} - F_{kw1yr})}{m_w} + \frac{F_{kfy} - F_{kwy}}{m_f} + \frac{M_{kwx} + M_{kwy}}{I_f} + \frac{b}{I_f} F_{k\psi}$$

$$F_{\mu sw1y} = \frac{m_f g \mu_s}{4m_w} [\sin \theta_{w1l} + \sin \theta_{w1r}] + \frac{g \mu_s}{4} [\sin \theta_{w1l} + \sin \theta_{w1r} + \sin \theta_{w2l} + \sin \theta_{w2r}] + \frac{m_f g \mu_s a b}{4I_f} [\cos \theta_{w1l} - \cos \theta_{w1r} + \cos \theta_{w2l} - \cos \theta_{w2r}] + \frac{m_f g \mu_s a^2}{4I_f} [\sin \theta_{w1l} + \sin \theta_{w1r} - \sin \theta_{w2l} - \sin \theta_{w2r}] \quad (24)$$

and

$$F_{\mu w2y} = \frac{(F_{w2y} - F_{kw2yl} - F_{kw2yr})}{m_w} + \frac{F_{kfy} - F_{kwy}}{m_f} + \frac{M_{kwx} + M_{kwy}}{I_f} + \frac{b}{I_f} F_{k\psi}$$

$$F_{\mu sw2y} = \frac{m_f g \mu_s}{4m_w} [\sin \theta_{w2l} + \sin \theta_{w2r}] + \frac{g \mu_s}{4} [\sin \theta_{w1l} + \sin \theta_{w1r} + \sin \theta_{w2l} + \sin \theta_{w2r}] + \frac{m_f g \mu_s a b}{4I_f} [\cos \theta_{w1l} - \cos \theta_{w1r} + \cos \theta_{w2l} - \cos \theta_{w2r}] + \frac{m_f g \mu_s a^2}{4I_f} [\sin \theta_{w1l} + \sin \theta_{w1r} - \sin \theta_{w2l} - \sin \theta_{w2r}] \quad (25)$$

From (20)–(21) for the stick state the presenting

friction forces are

$$F_{\mu pw1x} = \frac{m_m (m_w + m_f)}{m_f + 2m_w} F_{\mu tw1x} - \frac{m_w^2}{m_f + 2m_w} F_{\mu tw2x} \quad (26)$$

$$F_{\mu pw2x} = m_f F_{\mu tw1x} - \frac{m_f + m_w}{m_w} F_{\mu pw1x} \quad (27)$$

and

$$F_{\mu pw1\psi} = \left( F_{\mu tw1\psi} - \frac{a}{4I_f} (F_{\mu pw1y} - F_{\mu pw2y}) \right) I_w \quad (28)$$

$$F_{\mu pw2\psi} = \left( F_{\mu tw2\psi} - \frac{a}{4I_f} (F_{\mu pw1y} - F_{\mu pw2y}) \right) I_w \quad (29)$$

In the same way the other presenting friction forces in stick state can be derived without difficulty, where  $\mu_s$  and  $\mu_k$  denote static and kinematical friction coefficient respectively. There are many formulas to describe the friction coefficient change with the relative velocity (Popp, 1992) (Xia, 2002). In this paper the velocity-dependent friction coefficient  $\mu$  can be approximately described by the hyperbolic secant function as (Xia and True, 2003)

$$\mu(V_r) = \mu_s \sec h(\alpha |V_r|) + \mu_k (1 - \sec h(\alpha |V_r|)) \quad (30)$$

where  $V_r$  is the relative velocity between two bodies;  $\mu_s$  and  $\mu_k$  denote static and kinetic friction coefficient respectively. By the selection of different values of the parameter  $\alpha$  the formula yields different steepness of the continuous curve that describes the change from the static to the kinematical friction coefficient.

## 4. Simulation Results

The parameters of the wagon bogie used in Australia are shown in Table I.

The excitations on the wheelsets in longitudinal, lateral and yaw directions are described as a sinusoidal function in the form

$$F_{in} = A_m \sin(pt) \quad (31)$$

The total normal force on the surface between frame and a wheelset which is used to determine the friction force is set to be 10000 N.

**Table 1** Parameters of the wagon bogie

Terms	Symbols	Units	Values
Frame	$m_f$	kg	1359
Frame	$I_f$	kg·m <sup>2</sup>	550
Wheelset	$m_w$	kg	1120
Wheelset	$I_w$	kg·m <sup>2</sup>	160
Stiffness between Frame and wheelset	$k$	N/m	4e6
Static friction coefficient	$\mu_s$		0.4
Kinetical friction coefficient	$\mu_h$		0.3

**Case 1.**

In this case the exciting force on wheelset is only longitudinal and symmetrical, the friction on the surfaces between frame and wheelsets is only one-dimensional. The parameters are :  $A_m=10000$  N,  $p=3\pi$ . Figures 9 shows the exciting forces and Figure 10 shows the friction forces between the frame and front wheelset and the relative displacements. This is a one-dimensional friction case and the friction force in lateral direction is zero. The clearance between frame and wheelset is set to be 4 mm and it is found that the relative displacement takes up the clearance and impact between frame and wheelset takes place.

When small exciting force with the parameters of  $A_m=4000$  N,  $p=3\pi$  on wheelsets then the motion is always stuck as Fig. 11 shown.

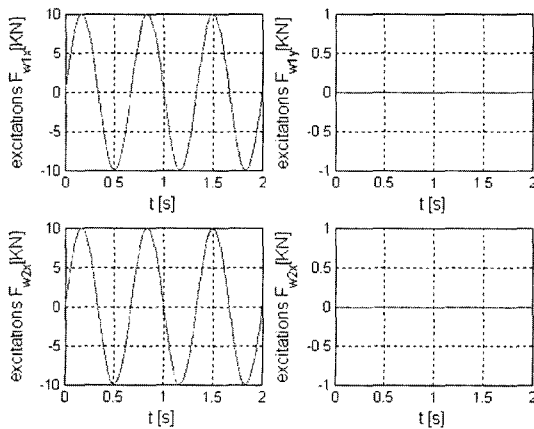

**Fig. 9** Exciting forces on wheelsets

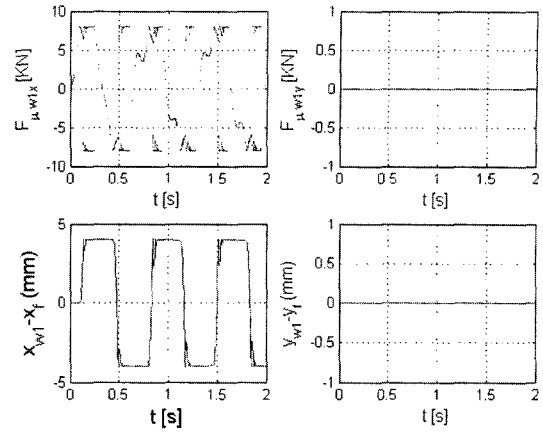

**Fig. 10** Friction forces and Relative displacements

In the stick state the present friction force is not zero and changes smoothly depending on the input forces and system parameters. The relative displacements between frame and wheelsets are zeros as they should be.

**Case 2.**

In this case the exciting forces on wheelset are in both longitudinal and lateral directions symmetrically, the friction on the surfaces between frame and wheelsets is two-dimensional. The parameters of the excitations are :  $A_{mx}=2000$  N,  $A_{my}=6000$  N,  $p=3\pi$ . Figure 12 shows the friction forces and the relative displacements in longitudinal and lateral direction respectively. Figure 13 shows the excitation forces.

It can be found that all the relative displacements

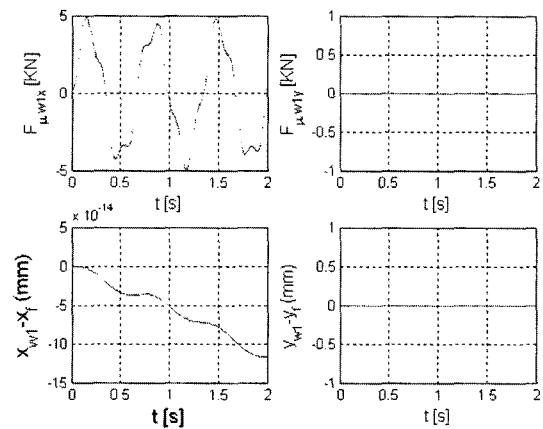

**Fig. 11** Friction force and relative displacements

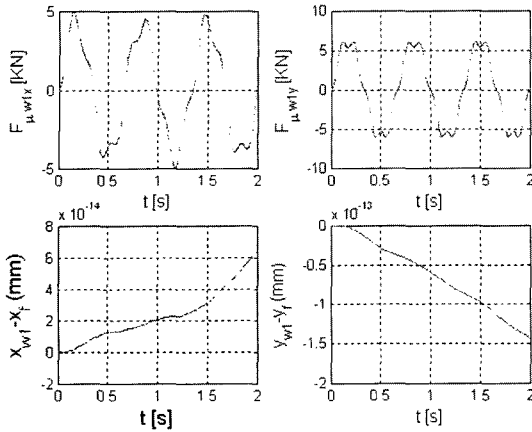

Fig. 12 Friction forces and relative displacements

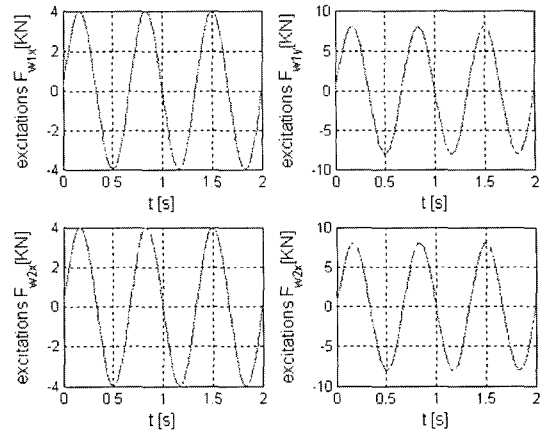

Fig. 15 Friction forces and relative displacements

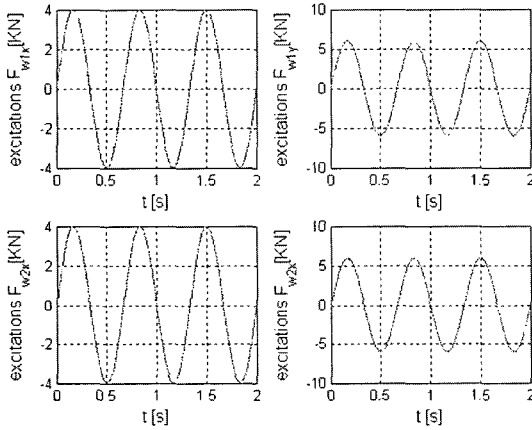

Fig. 13 Exciting forces on wheelsets

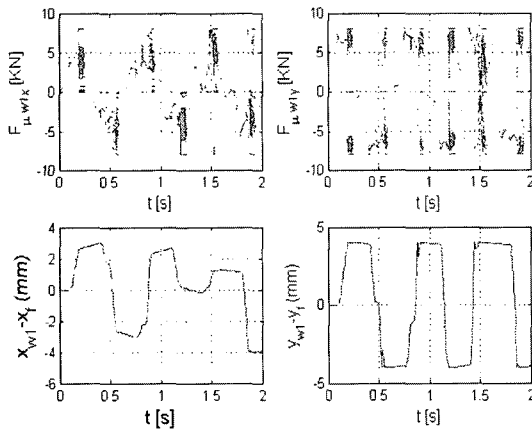

Fig. 14 Exciting forces on wheelsets

ments between frame and wheelsets are zeros at this level of excitations. If the excitation level

increases to a certain large level as shown in Fig. 14 then the stick-slip motion will take place. The results are shown in Fig. 15.

### 5. Conclusion

Systems with dry friction can be considered as structure varying multibody systems. The dynamic system is discontinuous and can be transferred into differentiable system by determination of friction forces for both slip and stick motions.

Using a friction element model to determine friction force is a simple and approximate method of treating stick-slip friction. It is easy to apply and avoids the need to use switching conditions, but the friction force in stick state is not stable.

The direct method can determine the friction force exactly but the switch conditions will make system complex. For a simple system it is practical but for a complicated system like wagon bogie it is not easy to derive all switch conditions and get the friction forces in stick state.

For the model developed in this paper, the frame and wheelsets remain stuck when the excitations on the wheelset are less than the level shown in Figs. 12 and 13.

### Acknowledgment

The paper is a part of research work of the



Cooperative Research Centre for Railway Engineering and Technologies of Australia (Rail CRC) project 1 of Theme 1 : National Centre of Simulation, Modelling and Derailment Investigation. The work is also obtained supports from Rail CRE and Faculty of Engineering and Physical Systems, Central Queensland University. Thanks due to Professor Dudley Roach for his supports in many ways.

### References

- ADAMS/Rail, 2002, *Building Templates in ADAMS/Rail, Version 12.0*, pp. 98~102.
- AEA Technology, 2002, *Vampire User Manual*, C2.2.4, Version 4.2.
- Eich-Soellner, E. and Führer, C., 1998, *Numerical Method in Multibody Dynamics*, Stuttgart.
- Popp, K., 1992, *Friction-Induced Vibration, Chatter, Squeal, and Chaos*, DE-Vol. 49. Some Model Problems Showing Stick-Slip Motion and Chaos.
- Xia, F. and Hans True, 2003, *The Dynamics of The Three-piece-Freight Truck*, 18<sup>th</sup> *IAVSD Symposium*, Aug. 24-30, Kanagawa, Japan.
- Xia, F., 2002, *The Dynamics of the Three-Piece-Freight Truck*, Ph.D. thesis, Informatics and Mathematical Modelling, The Technical University of Denmark.
- Xia, F., 2003, *Modelling of a Two-Dimensional CoulombFriction Oscillator*, *Journal of Sound and Vibration*, 265(5), pp. 1063~1074.