

Cultivation of *Gracilaria chorda* (Gracilariales, Rhodophyta) by Vegetative Regeneration

Ji Hwan Kim, Sa Dong Lee, Sung-Je Choi¹, Ik Kyo Chung² and Jong-Ahm Shin^{3,*}

Jangheung Maritime Affairs and Fisheries Office, Yeosu Regional Maritime Affairs and Fisheries Office, Jangheung 529-801,

¹Haenam Maritime Affairs and Fisheries Office, Mokpo Regional Maritime Affairs and Fisheries Office, Haenam 536-812,

²Department of Marine Science, Pusan National University, Busan 609-735 and

³Department of Aquaculture, College of Fisheries and Ocean Sciences, Yeosu National University, Yeosu 550-749, Korea

To make a preliminary identification of the gracilarioid plant attached to cultivation ropes of *Undaria pinnatifida* and establish a method of cultivating this plant, the first taxonomic and cultivation studies on this species in Korea were conducted. This gracilarioid plant was identified from its morphological and anatomical features, as *Gracilaria chorda*. Growth tests using the 10, 20, and 30 cm cuttings of axes of *G. chorda* were performed twice, from May 3 to August 21, 2002 and from December 15, 2002 to April 3, 2003 in Ihojin aquafarm, Hoijin, Jangheung, Jeollanamdo, Korea. In the first growing test, the thallus length of the 10, 20, and 30 cm cuttings increased twelve-fold, ten-fold, and seven-fold; the wet weight increased 81-fold, 60-fold, and 41-fold; the numbers of more than 10 cm-long branches increased 3.8-fold, 5.2-fold, and 6.1-fold, respectively. In the second growth test, the thallus length of the 10, 20, and 30 cm cuttings increased seven-fold, 5.5-fold, and four-fold; the wet weight increased 81-fold, 53-fold and 36-fold; the number of branches increased 3.8-fold, 7.3-fold, and 6.6-fold, respectively. The cultivation of *G. chorda* by vegetative regeneration using cuttings of thallus axes was successful for the first time in Korea.

Key Words: cultivation, *Gracilaria chorda*, vegetative regeneration

INTRODUCTION

Red algal gracilarioids, comprising more than 150 species, are widely distributed geographically; the majority of species are reported from warm-water/tropical regions. Populations can form monospecific stands or multispecies/multigeneric communities. The major production areas in the world are Chile, Malaysia, Thailand, New Zealand, the Philippines, Indonesia, China, Taiwan, and South Africa (Critchley 1997).

The taxonomy of this economically important agar-producing group which has complicated identification of species has been described as "chaotic" (Chapman *et al.* 1977; Bird and Rice 1990; Steentoft *et al.* 1991; Bird 1995). Adding to the confusion, recent research has determined that, in some cases, polymorphism and variation within a single species can be great enough to incorporate descriptions of more than one previously described entity. Increasing the problems of species recognition

are other instances where apparently similar morphology, described as one species, in fact do contain more than one distinct species or even genus (Bird *et al.* 1982; Fredericq and Hommersand 1989 a, b).

As well as providing fresh vegetables (Abbott 1988), gracilarioids are the major source of food-grade agar (McHugh 1991) and the research chemical agarose (Renn 1990). They are used as feed for useful marine organisms such as abalones (Chiang 1981) and rabbitfish (*Siganus*) (von Westernhagen 1973, 1974). Monocultures and polycultures with milkfish (*Chanos chanos*), shrimps (*Penaeus monodon*) or crabs (*Scylla serrata*) among others, have also been used (Oliveira and Alveal 1990). Gracilarioid algae are also recognized as potential sources of pharmaceuticals such as antiviral compounds (Neushul 1990), anti-tumor compounds (Noda *et al.* 1990) and haemagglutinins (Hori *et al.* 1990; Okamoto *et al.* 1990), and arachidonic and eicosapentaenoic acids have also been detected (Araki *et al.* 1990; Gerwick *et al.* 1993); the potential value of gracilarioids has increased (Armisen 1995).

Gracilarioids in Korea comprise eight (Lee and Kang

*Corresponding author (shin@yosu.ac.kr)

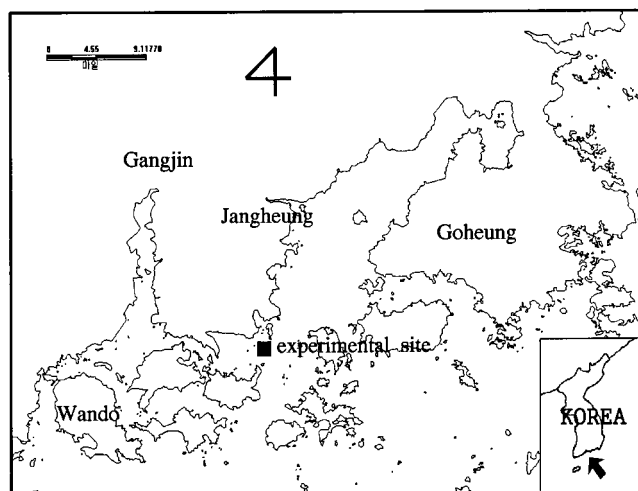

Fig. 1. A map showing the experimental site in Jangheung on the southwestern coast of Korea.

1986) to ten species (Lee and Kang 2001). Only a few studies on Korean *Gracilaria vermiculophylla* (as *Gracilaria verrucosa*) have been reported: fundamental observations on *Gracilaria* culture (Koh 1969), phenology and morphology (Kim *et al.* 1993), reproductive phenology (Kim *et al.* 1998), the effects of light, desiccation, and salinity for spore discharge (Kim *et al.* 2001), temperature and light responses in growth and the potential for mariculture (Kim *et al.* 2002). Studies on cultivation in aquafarms, however, have not been conducted.

The material used in this study is a kind of gracilarioid algae, which is called “Geumcho” (the meaning is “money-making seaweed”). At present, this gracilarioid plant grows on cultivation ropes of *Undaria* and *Laminaria* at aquafarms in Ihojin, Jangheung, and in Poongnam, Myeongcheon and Ocheon, Goheung, Jeollanamdo.

To identify this gracilarioid plant and establish a method of cultivating it, a preliminary morphological study was conducted, and an aquaculture experiment by vegetative regeneration was performed, both for the first time in Korea (e.g. Raju and Thomas 1971; Goldstein 1973).

MATERIALS AND METHODS

For cultivation using its vegetative regeneration, individuals of *Gracilaria* sp. from cultivation ropes of *Undaria pinnatifida* at Ihojin aquafarm in Hoijin, Jangheung, Jeollanamdo, Korea (Fig. 1), were cut to 10, 20, and 30 cm fragments from single individual. The greater part of a thallus from the tip to the near holdfast

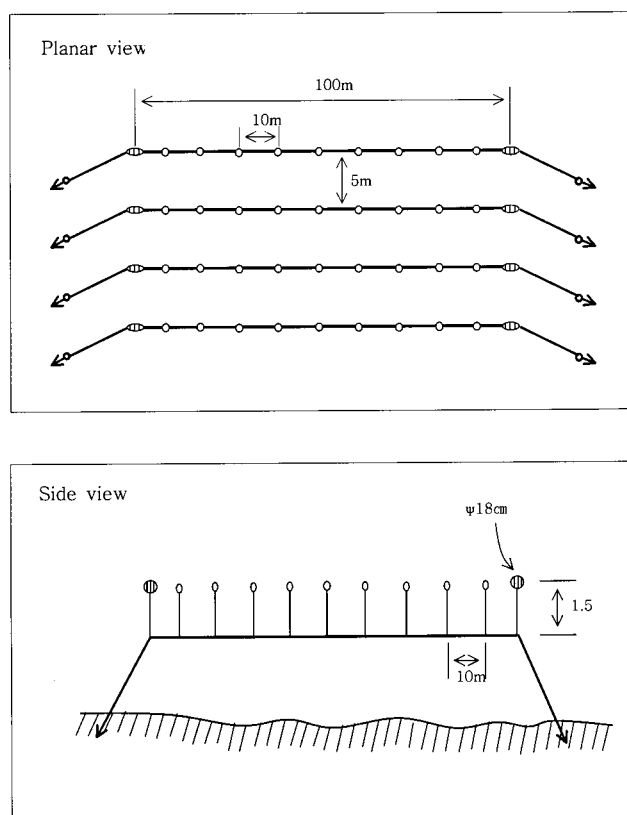

Fig. 2. A planar view and an side view of the cultivation facilities.

was used as a cutting. A bundle of ten to twenty cuttings of each fragment were inserted into ropes of 10 mm diameter at 10-20 cm intervals, and cultivated by a rope-hanging method (Fig. 2). The main ropes were maintained below 1.5 m of depth. The first and the second growth test were performed at Ihojin aquafarm (Fig. 1) from May 3, 2002 to August 21, 2002 and from December 15, 2002 to April 3, 2003, respectively.

The length and wet weight of fragment and the number of branches more-than-10 cm-long cuttings selected randomly from 30 regenerates were measured once or twice per month. The transformed data of each traits using natural log were used to estimate the relative growth rates (Evans 1972; Hunt 1982). Water temperature and specific gravity were measured when the plants were sampled. Other adhesive algae were regularly removed once in every month to foster gracilarioid growth.

RESULTS AND DISCUSSION

The experimental site, Ihojin aquafarm, is located in the lower part of Deungnyang Bay, between Gogeu Island, Wando, to the south and Maryang, Gangjin, to

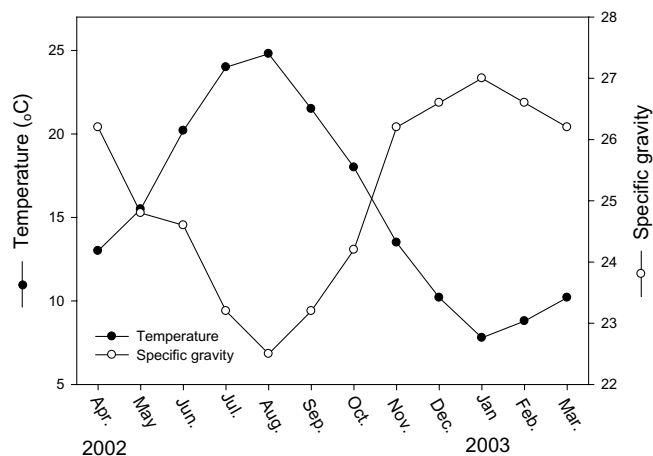

Fig. 3. Fluctuations of water temperature and specific gravity at the experimental site in Jangheung, southwestern coast of Korea.

the west (Fig. 1). Rock beds are along the shoreline; lots of gravels and a vast mud flat are in the intertidal zone; the water flow is relatively slow; the bottom is mud from the lowest low water level to the four-hour exposure level, and gravel and rock beds are in the upper zone from the four-hour exposure level. Water transparency is very low, with 0.8-2.0 m. The dominant species in the intertidal zone are *Enteromorpha prolifera*, *Monostroma nitidum*, *Ulva lactuca*, and *Enteromorpha crinita*. *Porphyras* also grow.

Porphyras, *Undaria pinnatifida*, *Costaria costata*, *Laminaria japonica*, *Hizikia fusiformis*, and *Codium fragile* are cultivated in the aquafarm. Various algae such as *Sargassum*, *Chondrus*, *Neosiphonia*, *Briopsis*, and *Gracilaria* inhabit in this area.

The *Gracilaria* sp. used in this study differs greatly from the *G. vermiculophylla* growing the intertidal zone in points of morphology. The thallus width of the two is similar, 1.2-2.5 mm. The thallus length of the *Gracilaria* sp. is 2-4 m as a mean value and up to 7 m, compared to *G. vermiculophylla* which has a thallus length of 4-30 cm. This species is an erect, terete axe with lateral branches. The branches are sometimes longer and thicker than original fronds. The number of branches of this species is fewer than that of *G. vermiculophylla*. *Gracilaria* sp. is attached to cultivation ropes of *Undaria pinnatifida* or *Laminaria japonica*, and *G. vermiculophylla* is mainly attached to pebbles and shells. These features of *Gracilaria* sp. coincide well with those of *G. chorda* described by Yoshida (1998), Yamamoto (1978), and Ohmi (1958). The morphological data will be reported elsewhere.

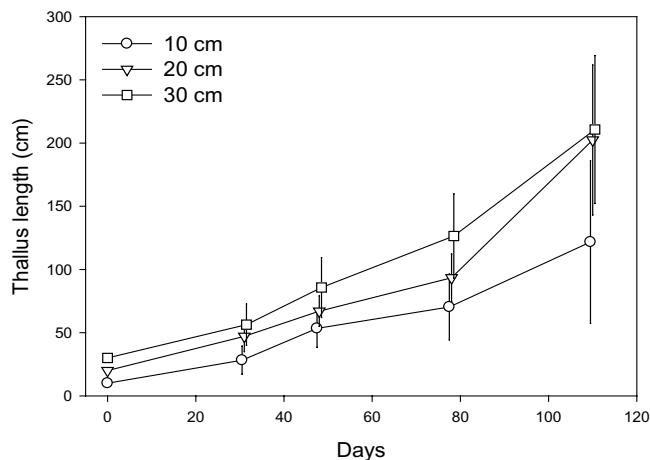

Fig. 4. Changes of thallus length of cuttings cut from individuals of *Gracilaria chorda* cultivated at the experimental site in the 2002 *Gracilaria* year.

Table 1. Thallus length of cuttings cut from individuals of *Gracilaria chorda* cultivated at the experimental site in the 2002 *Gracilaria* year

Cutting length/thallus length (days of cultivation)	Thallus length (mean, cm)				
	May 3 (0)	Jun. 4 (32)	Jun. 20 (48)	Jul. 20 (78)	Aug. 21 (110)
10 cm	10	28.27	53.40	70.20	121.70
20 cm	20	47.10	67.03	93.40	202.43
30 cm	30	56.33	85.70	126.43	210.73

Cutting length/relative growth rate (growth period in day)	Relative growth rate				
	0-32	32-48	48-78	78-110	0-110
10 cm	0.032	0.040	0.009	0.017	0.023
20 cm	0.027	0.022	0.011	0.024	0.021
30 cm	0.020	0.026	0.013	0.016	0.018

The water temperature was 7.8-24.8°C and the specific gravity 1.0218-1.0270 (Fig. 3). In the first growing test, on June 4, 2002 through 31 days of cultivation, the 10 cm cuttings regrew to 28.27 ± 1.05 cm, the 20 cm cuttings to 47.10 ± 12.12 cm, and the 30 cm long to 56.33 ± 16.26 cm (Fig. 4 and Table 1). All of the cuttings regrew, but the regrowth patterns were variable, such as long regrowth with few branches and short regrowth with many branches. In case of inserting thick cuttings with a few small branches, the cuttings did not grow long and increased in number of branches. In case of inserting thin cuttings with few branches whose tip was distant from the holdfast, the cuttings tended to grow long and to have a small number of branches.

The color of regenerates was yellowish red, while the

original color of *Gracilaria* is nearly reddish purple. This tendency, however, was found only in the inserted blades. The thick-grown cuttings and their branches among the natural ones in this season are tinged mostly with yellow.

The *Gracilaria chorda* cuttings inserted into the cultivation ropes grew well without individuals almost falling off the ropes. A new holdfast-form from the part inserted into the ropes was not made and not attached to the ropes, the inserted part resembling a holdfast with the naked eye, becoming in fact a holdfast (data not shown).

On June 20, 2002, after 48 days of cultivation, the 10 cm cuttings grew to 53.40 ± 4.97 cm, the 20 cm cuttings to 67.03 ± 12.03 cm, and the 30 cm cuttings to 85.70 ± 23.67 cm. Individuals more than 100 cm long appeared among the 30 cm cuttings, and a few thickened individuals began to exhibit cystocarps, small protuberances; maturation seemed to begin before and after this time; thick-grown cuttings seemed to mature more quickly. These resembled natural *Gracilaria chorda* on the *Undaria* cultivation ropes. These were tinged with yellow, like the individuals sampled on June 4, 2002.

On July 20, 2002, after 78 days of cultivation, the 10 cm cuttings grew to 70.20 ± 26.00 cm, the 20 cm cuttings to 93.40 ± 18.72 cm, and the 30 cm cuttings to 126.43 ± 33.29 cm. A few individuals were more than 200 cm long, and a few individuals were fell off the rope.

Mature individuals increased in number, and cystocarps formed over the whole thallus. Twenty to 30% of the examined individuals showed that they were mature, having formed protuberances. Among the wild *G. chorda* attached to the *Undaria* cultivation rope, plants showed more than 90% maturation in the areas of high seawater temperature and low water depth. Among the wild plants, they showed 70-80% maturation in the areas of low seawater temperature and deep water depth where the effect of atmospheric temperature was relatively small. Judging from this growth, the seeding time of *G. chorda* for artificial seeding production was thought to be best at about July 20.

On August 21, 2002, after 110 days of cultivation, the 10 cm cuttings grew to 121.70 ± 64.24 cm, the 20 cm cuttings to 202.43 ± 59.29 cm, and the 30 cm cuttings to 210.73 ± 58.53 cm. The growth of the cuttings was rapid and continued in spite of reaching the peak of seawater temperature. Various epiphytic organisms on the thalli, however, increased greatly. The number of individuals falling off the ropes with the increase of length began to

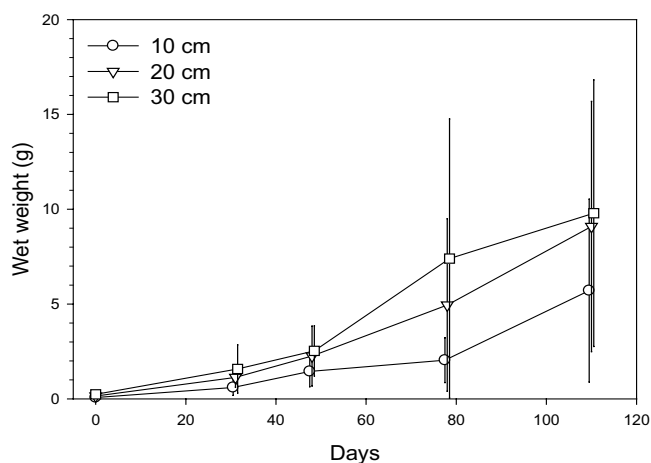

Fig. 5. Changes of wet weight of cuttings cut from individuals of *Gracilaria chorda* cultivated at the experimental site in the 2002 *Gracilaria* year.

Table 2. Wet weight changes of cuttings cut from individuals of *Gracilaria chorda* cultivated at the experimental site in the 2002 *Gracilaria* year

Cutting length/thallus length (days of cultivation)	Thallus length (mean, cm)				
	May 3 (0)	Jun. 4 (32)	Jun. 20 (48)	Jul. 20 (78)	Aug. 21 (110)
10 cm	0.07	0.60	1.45	2.04	5.71
20 cm	0.15	1.13	2.26	4.95	9.09
30 cm	0.24	1.58	2.53	7.40	9.79

Cutting length/relative growth rate (growth period in day)	Relative growth rate				
	0-32	32-48	48-78	78-110	0-110
10 cm	0.067	0.055	0.011	0.032	0.040
20 cm	0.063	0.043	0.026	0.019	0.037
30 cm	0.059	0.029	0.036	0.009	0.034

increase gradually. Storms and typhoons in the summer season reduced the elasticity of *G. chorda*, and consequently the number of individuals falling from the parts inserted into the ropes increased greatly.

In the summer, the degree of adhesion of harmful organisms such as copepods, calcareous algae, and *Mytilus edulis*, to the ropes and blades, became severe. *G. chorda* has economic value only when the various organisms attached to thalli are removed at the time of harvesting. Therefore, it is thought to not be edible when harvested in the summer season, and it is considered that finding new uses for *G. chorda* harvested in summer, such as agar production and abalones' feed are important.

The relative growth rate of the 10 cm cuttings was the

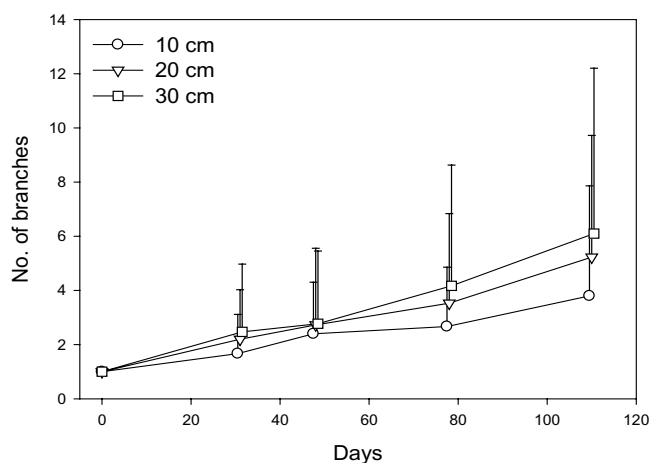

Fig 6. Changes of number of branches of cutting cut from individuals of *Gracilaria chorda* cultivated at the experimental site in the 2002 *Gracilaria* year.

Table 3. Change in the number of branches of cuttings cut from individuals of *Gracilaria chorda* cultivated at the experimental site in the 2002 *Gracilaria* year

Cutting length/thallus length (days of cultivation)	Thallus length (mean, cm)				
	May 3 (0)	Jun. 4 (32)	Jun. 20 (48)	Jul. 20 (78)	Aug. 21 (110)
10 cm	1	1.67	2.40	2.67	3.80
20 cm	1	2.20	2.73	3.53	5.23
30 cm	1	2.47	2.77	4.17	6.10

Cutting length/relative growth rate (growth period in day)	Relative growth rate				
	0-32	32-48	48-78	78-110	0-110
10 cm	0.016	0.023	0.004	0.011	0.012
20 cm	0.025	0.013	0.009	0.012	0.015
30 cm	0.028	0.007	0.014	0.012	0.016

highest, and that of the 30 cm cuttings was the lowest (Table 1). Fig. 5 and Table 2 show the initial wet weight of the 10, 20, and 30 cm cuttings and the effects of the passage of time of net weight during the growth test.

The initial wet weight of the 10, 20, and 30 cm cuttings were 0.07, 0.15 and 0.24 g. After 32 days of cultivation, the 10 cm cuttings increased in weight to 0.60 ± 0.42 g, the 20 cm cuttings to 1.13 ± 0.51 g, and the 30 cm cuttings to 1.58 ± 1.27 g. After 48 days of cultivation, the 10 cm cuttings increased in weight to 1.45 ± 0.81 g, the 20 cm cuttings to 2.26 ± 1.58 g and the 30 cm cuttings to 2.53 ± 1.32 g. After 78 days of cultivation, the 10cm cuttings increased in weight to 2.04 ± 1.1 g, the 20 cm cuttings to 4.95 ± 4.55 g, and the 30 cm cuttings to 7.40 ± 7.36 g. After 110 days of cultivation, the 10 cm cuttings

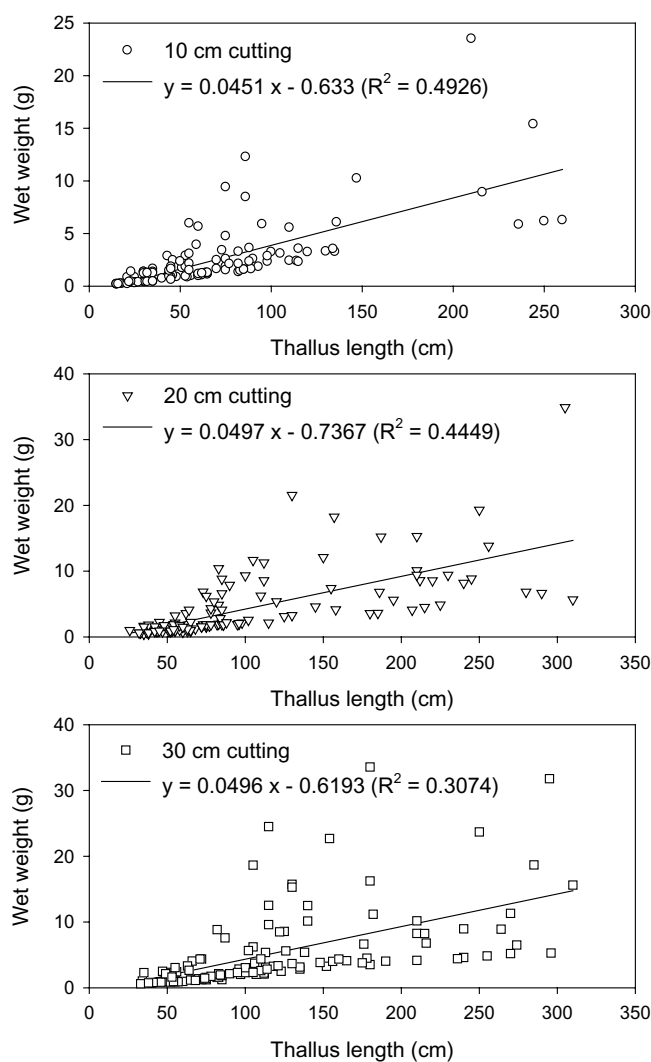

Fig. 7. Relationship between thallus length and wet weight of three cuttings in *Gracilaria chorda* in the 2002 *Gracilaria* year.

increased in weight to 5.71 ± 4.82 g, the 20 cm cuttings to 9.09 ± 6.59 g, and the 30 cm cuttings 9.79 ± 7.03 g.

The wet weight of the 10 cm cuttings increased rapidly after July, 2002, and the weights of the 20 and 30 cm cuttings increased rapidly from late June, 2002 (Fig. 5). The relative growth rate of the 10 cm cuttings was the highest, and that of the 30 cm long was the lowest (Table 2).

The increase of wet weight might be result from enlargement of thallus width and increase of branches, among other causes, as well as elongation of thallus length.

Fig. 6 and Table 3 show the increase of the number of branches. Only branches of more than 10 cm in length were counted because the gracilarioid had many branches. Each cutting has only one branch. After 32 days of cultivation, the branches of the 10, 20 and 30 cm

Table 4. Analysis of variance between thallus length and wet weight of three kinds of cuttings in *Gracilaria chorda* in the 2002 *Gracilaria* year

Cutting length	Source of variation	Sum of squares	Degree of freedom	Mean of squares	F _s	F _{0.01}
10 cm	Regression	261088.81	1	261088.81	213.59	6.76
	Residual	290930.2	238	1222.4		
	Total	552019.01	239			
20 cm	Regression	577825.75	1	577825.75	247.56	6.76
	Residual	555500.8	238	2334.04		
	Total	1133326.55	239			
30 cm	Regression	786332.21	1	786332.21	331.24	6.76
	Residual	564989.49	238	2373.91		
	Total	1351321.7	239			

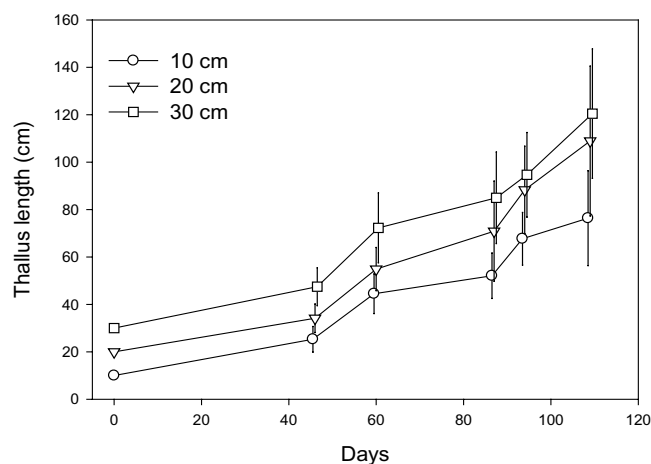

Fig. 8. Changes of thallus length of cuttings cut from individuals of *Gracilaria chorda* cultivated at the experimental site in the 2003 *Gracilaria* year.

cuttings numbered 1.67 ± 1.45 , 2.20 ± 1.83 and 2.47 ± 2.50 individuals, respectively. After 48 days of cultivation, the branches of the 10, 20 and 30 cm cuttings numbered 2.40 ± 1.90 , 2.73 ± 2.83 , and 2.77 ± 2.69 individuals. After 78 days of cultivation, the branches of the 10, 20, and 30cm cuttings were 2.67 ± 2.19 , 3.53 ± 3.31 , and 4.17 ± 4.46 individuals. After 110 days of cultivation, the branches of the 10, 20, and 30cm cuttings were 3.80 ± 4.06 , 5.23 ± 4.49 , and 6.10 ± 6.10 individuals. The relative growth rate of the 30 cm cuttings was the highest, and that of the 10 cm cuttings was the lowest (Table 3).

Branch numbers might lead to an increase of the wet weight of this gracilarioid because the length and width of the branches were bigger than those of the axes in many cases.

Fig. 7 shows the relationship between the thallus length and the wet weight of the 10, 20, and 30 cm cuttings in the 2002 *Gracilaria* year. The slopes were

Table 5. Thallus length (cm) of cuttings cut from individuals of *Gracilaria chorda* cultivated at the experimental site in the 2003 *Gracilaria* year

Cutting length/thallus length (days of cultivation)	Thallus length (mean, cm)					
	Dec. 15 (0)	Jan. 30 (46)	Feb. 13 (60)	Mar. 12 (87)	Mar. 19 (94)	Apr. 3 (109)
10 cm	10	25.3	44.5	52.1	67.7	76.4
20 cm	20	34.2	54.7	70.9	88.3	108.9
30 cm	30	47.5	72.3	85.0	94.7	120.4

Cutting length/relative growth rate (growth period in day)	Relative growth rate					
	0-46	46-60	60-87	87-94	94-109	0-109
10cm	0.020	0.040	0.006	0.037	0.008	0.019
20cm	0.012	0.034	0.010	0.031	0.014	0.016
30cm	0.010	0.030	0.006	0.015	0.016	0.013

similar among treatments. The coefficient of determination of the 10 cm cuttings was the highest, and that of the 30 cm cuttings was the lowest. About 50% of the total variation in wet weight is explained by the fitted regression.

Table 4 shows an analysis of the variance between the thallus length and wet weight of the 10, 20, and 30 cm cuttings in the 2002 *Gracilaria* year. The variance showed statistical significance at the 1% level.

The second experiment on this gracilarioid using the 10, 20, and 30 cm cuttings was performed from December 15, 2002 to April 3, 2003. Fig. 8 and Table 5 show the change of thallus length. After 46 days of cultivation, the length of the 10, 20, and 30 cm cuttings increased to 25.3 ± 5.40 , 34.17 ± 6.01 , and 47.47 ± 7.97 cm, respectively. After 60 days of cultivation, the length of the 10, 20, and 30 cm cuttings was 44.50 ± 8.34 , $54.70 \pm$

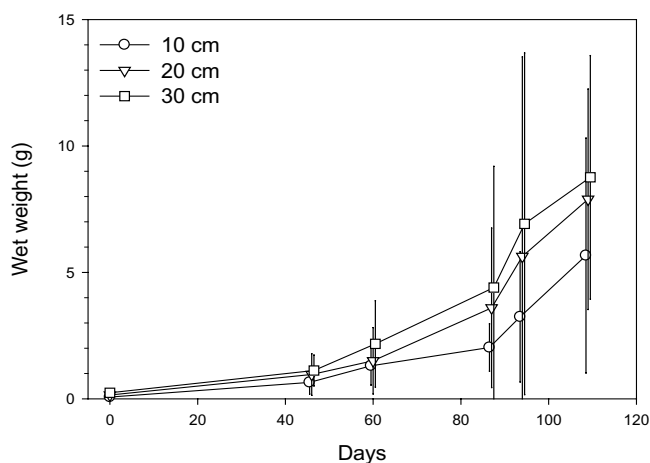

Fig. 9. Changes of wet weight of cuttings cut from individuals of *Gracilaria chorda* cultivated in the experimental site in the 2003 *Gracilaria* year.

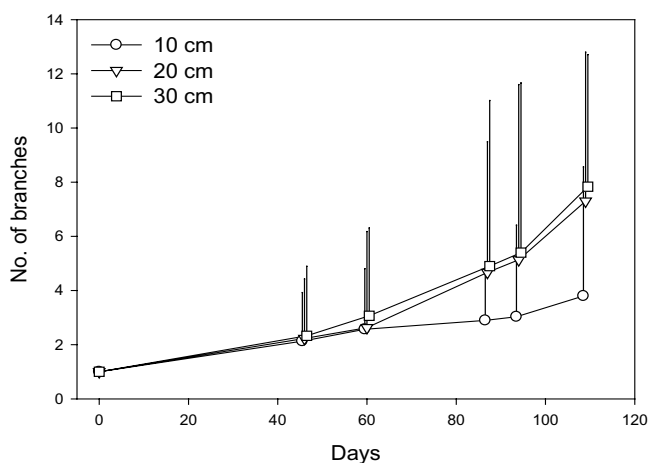

Fig. 10. Changes of number of branches of cuttings cut from individuals of *Gracilaria chorda* cultivated at the experimental site in the 2003 *Gracilaria* year.

Table 6. Change of wet weight of cuttings cut from individuals of *Gracilaria chorda* cultivated at the experimental site in the 2003 *Gracilaria* year

Cutting length/thallus length (days of cultivation)	Thallus length (mean, cm)					
	Dec. 15 (0)	Jan. 30 (46)	Feb. 13 (60)	Mar. 12 (87)	Mar. 19 (94)	Apr. 3 (109)
10 cm	0.07	0.65	1.31	2.03	3.24	5.67
20 cm	0.15	0.96	1.51	3.60	5.64	7.89
30 cm	0.24	1.12	2.17	4.40	6.92	8.76

Cutting length/relative growth rate (growth period in day)	Relative growth rate					
	0-46	46-60	60-87	87-94	94-109	0-109
10cm	0.048	0.050	0.016	0.067	0.037	0.040
20cm	0.040	0.032	0.032	0.064	0.022	0.036
30cm	0.033	0.047	0.026	0.065	0.016	0.033

Table 7. Number of branches of cuttings cut from individuals of *Gracilaria chorda* cultivated at the experimental site in the 2003 *Gracilaria* year

Cutting length/thallus length (days of cultivation)	Thallus length (mean, cm)					
	Dec. 15 (0)	Jan. 30 (46)	Feb. 13 (60)	Mar. 12 (87)	Mar. 19 (94)	Apr. 3 (109)
10 cm	1	2.13	2.57	2.90	3.03	3.80
20 cm	1	2.23	2.63	4.67	5.13	7.30
30 cm	1	2.33	3.07	4.90	6.92	8.76

Cutting length/relative growth rate (growth period in day)	Relative growth rate					
	0-46	46-60	60-87	87-94	94-109	0-109
10 cm	0.016	0.013	0.004	0.006	0.015	0.012
20 cm	0.017	0.012	0.021	0.013	0.024	0.018
30 cm	0.018	0.020	0.017	0.049	0.016	0.020

9.11, and 72.30 ± 14.69 cm. After 87 days of cultivation, the length of the 10, 20, and 30 cm cuttings was 41.97 ± 10.59, 70.90 ± 21.12, and 84.97 ± 19.29 cm. After 94 days of cultivation, the length of the 10, 20, and 30 cm cuttings was 76.40 ± 11.09, 88.30 ± 18.42, and 94.67 ± 17.84 cm. After 109 days of cultivation the length of the 10, 20, and 30 cm cuttings was 76.40 ± 20.01, 108.93 ± 31.60, and 120 ± 27.27 cm. The relative growth rate of the 10 cm cuttings was the highest, and that of the 30 cm cuttings was the lowest (Table 5).

Fig. 9 and Table 6 show the changes of the wet weight. After 46 days of cultivation, the increase in weight of the 10, 20, and 30 cm cuttings were 0.65 ± 0.46, 0.96 ± 0.82, and 1.12 ± 0.61 g, respectively. After 60 days of

cultivation, those of the 10, 20, and 30 cm cuttings were 1.31 ± 0.76, 1.51 ± 1.31, and 2.17 ± 1.71 g. After 87 days of cultivation, the weights of the 10, 20, and 30 cm cuttings were 1.48 ± 1.07, 3.60 ± 3.15, and 4.40 ± 4.79 g. After 94 days of cultivation, those of the 10, 20, and 30cm cuttings were 3.24 ± 2.57, 5.64 ± 7.89, and 6.92 ± 6.76 g. After 109 days of cultivation, those of the 10, 20, and 30 cm cuttings were 5.76 ± 4.65, 7.89 ± 4.36, and 8.76 ± 4.82 g.

The relative growth rate of the 10 cm cuttings was the highest, and that of 30 cm cuttings was the lowest (Table 6). The growth of cuttings increased gradually during December 2002, and January and February 2003, at low sea water temperature; the growth increased rapidly from late February while the temperature was gradually

Table 8. Analysis of variance between thallus length and wet weight of three cuttings in *Gracilaria chorda* in the 2003 *Gracilaria* year

Cutting length	Source of variation	Sum of squares	Degree of freedom	Mean of squares	F _s	F _{0.01}
10 cm	Regression	177918.1	1	177918.1	717.3	6.73
	Residual	73913.9	298	248.0		
	Total	251832.0	299			
20 cm	Regression	343286.5	1	343286.5	646.3	6.73
	Residual	158270.7	298	531.1		
	Total	501557.2	299			
30 cm	Regression	471609.0	1	471609.0	995.6	6.73
	Residual	141160.8	298	473.6		
	Total	612769.8	299			

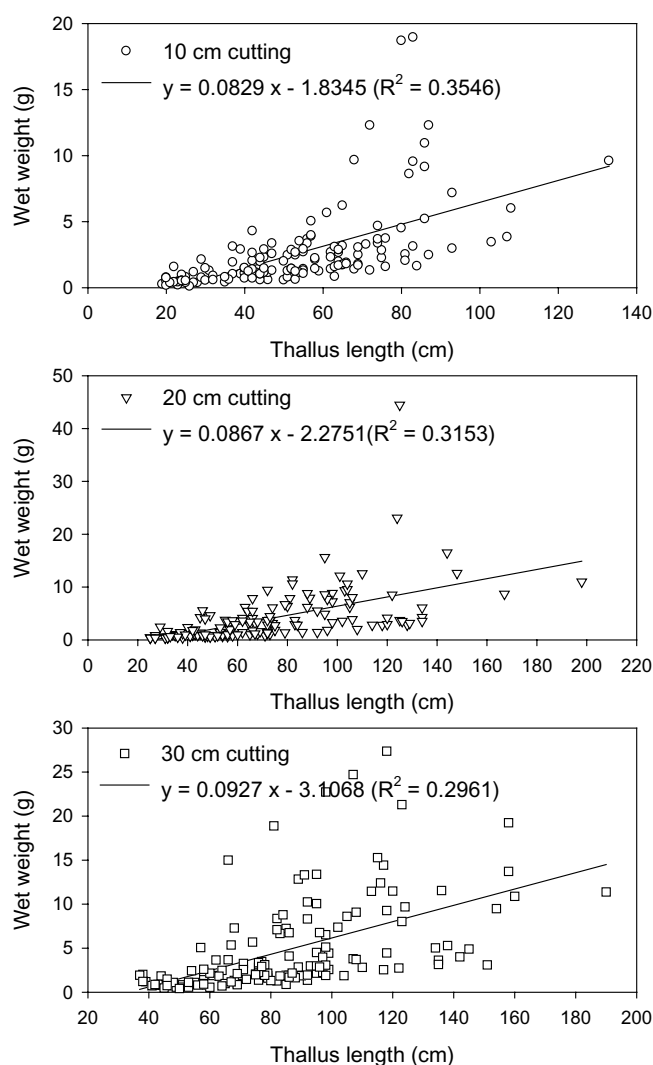

Fig. 11. Relationship between thallus length and wet weight of three cuttings in *Gracilaria chorda* in the 2003 *Gracilaria* year.

increasing.

Fig. 10 and Table 7 show the increase of the number of branches. After 46 days of cultivation, the number of branches of the 10, 20, and 30 cm cuttings were $2.13 \pm$

1.80 , 2.07 ± 1.89 , and 1.83 ± 1.46 , respectively. After 60 days of cultivation, the numbers of branches were 2.57 ± 2.24 , 2.63 ± 3.55 , and 4.79 ± 2.33 . After 87 days of cultivation, the numbers of branches were 2.30 ± 1.82 , 4.67 ± 4.82 , and 4.30 ± 5.31 . After 94 days of cultivation, the numbers of branches of 10, 20, and 30 cm cuttings were 3.03 ± 3.38 , 3.53 ± 3.90 , and 5.40 ± 6.26 . After 109 day of cultivation, the numbers of branches of the 10, 20, and 30 cm cuttings were 3.80 ± 4.76 , 7.30 ± 5.50 , and 6.63 ± 4.57 .

The relative growth rate of the 30 cm cuttings was the highest, and that of the 10 cm cuttings was the lowest (Table 7).

The numbers of branches were almost the same among the three groups when the seawater temperature was low, but were different in the 10 cm cuttings, and 20 and 30 cm cuttings increased from late February when the seawater temperature increased.

Fig. 11 shows the relationship between the thallus length and the wet weight of the 10, 20, and 30 cm cuttings in the 2003 *Gracilaria* year. The slopes of cuttings were similar. The coefficient of determination of the 10 cm cuttings was the highest, and that of the 30 cm cuttings was the lowest. The value of all in the 2003 *Gracilaria* year was lower than in the 2002 *Gracilaria* year. This could be caused by the lower nutrient concentrations in summer season than those of 2002 *Gracilaria* year in winter.

Table 8 shows an analysis of variance between the thallus length and the wet weight of the 10, 20, and 30 cm cuttings in the 2003 *Gracilaria* year. The variance showed statistical significance at the 1% level.

Studies on the effect of water temperature on the growth of gracilarioids have been reported (Jones 1959; Penniman *et al.* 1986). Causely *et al.* (1946), Edelstein *et al.* (1976), and McLachlan and Bird (1984) reported that the

water temperature for the maximum growth of gracilarioids was about 25-30°C. Kim *et al.* (2002) also reported that the growth of Korean *G. vermiculophylla* (as *G. verrucosa*) from a laboratory culture was the best at 25°C. In this study, the growth of *G. chorda* was the best from July to August in the summer (Figs 3, 4, and 8; Tables 1 and 5). The water temperature of about 25°C might be the most adequate for growing Korean *G. chorda*.

In the first growing test, the thallus length of the 10, 20, and 30 cm cuttings increased twelve-fold, ten-fold, and seven-fold, respectively; the wet weight increased 81-fold, 64-fold, and 41-fold; the number of branches of more than 10 cm long increased 3.8-fold, 5.2-fold, and 6.1-fold. In the second growing test, the thallus length of the 10, 20, and 30 cm cuttings increased seven-fold, 5.5-fold and four-fold; the wet weight of the 10, 20, and 30cm cuttings increased 81-fold, 53-fold, and 36-fold; the number of branches increased 3.8-fold, 7.3-fold, and 6.6-fold, respectively.

The cultivation of *G. chorda* by vegetative regeneration using cuttings of thallus axes was successful for the first time in Korea. Based on the operational effort and the preparation of stocking materials the 20-cm cutting method is recommended for practical cultivation. These results show that the cultivation of *G. chorda* is quite within the bounds of possibility.

REFERENCES

- Abbott I.A. 1988. Food products from seaweeds. In: Lembi C.A. and Waaland J.R. (eds), *Algae and Human Affairs*. Cambridge Univ. Press. pp. 135-148.
- Araki S., Sakurai T., Oohusa T., Kayama M. and Nisizawa K. 1990. Content of arachidonic and eicosapentaenoic acid in polar lipids from *Gracilaria* (Gracilariales, Rhodophyta). *Hydrobiologia* **204/205**: 513-519.
- Armisen R. 1995. World-wide use and importance of *Gracilaria*. *J. Appl. Phycol.* **7**: 231-243.
- Bird C.J. 1995. A review of recent taxonomic concepts and developments in the Gracilaceae (Rhodophyta). *J. Appl. Phycol.* **7**: 255-267.
- Bird C.J. and Rice E.L. 1990. Recent approach to the taxonomy of the Gracilariaceae (Gracilariales, Rhodophyta) and the *Gracilaria verrucosa* problem. *Hydrobiologia* **204/205**: 111-118.
- Bird C.J., van der Meer J.P. and McLachlan J. 1982. A comment on *Gracilaria verrucosa* (Huds.) Papenf. (Rhodophyta, Gigartinales). *J. Mar. Biol. Ass. U.K.* **62**: 453-527.
- Causely J.T., Prytherch J.P., McCaskill J., Macchiavello J., Gonzales S. and Ambler R. 1946. Influence of environmental factors upon the growth of *Gracilaria confervoides*. *Bull. Duke Univ. Mar. Stn.* **3**: 19-24.
- Chapman A.R.O., Edelstein T. and Power P.T. 1977. Studies on *Gracilaria*. I. Morphological and anatomical variation in samples from the Lower Gulf of St. Lawrence and New England. *Bot. Mar.* **20**: 149-153.
- Chiang Y.-M. 1981. Cultivation of *Gracilaria* (Rhodophycophyta, Gigartinales) in Taiwan. *Proc. Int'l. Seaweed Symp.* **10**: 569-574.
- Critchley A.T. 1997. *Gracilaria* (Gracilariales, Rhodophyta): An Economically important agarophyte. In: Ohno M. and Critchley A. T. (eds), *Seaweed Cultivation and Marine Ranching*. JICA. pp. 89-112.
- Edelstein T., Bird C. and McLachlan J. 1976. Studies on *Gracilaria*. 2. Growth under greenhouse conditions. *Can. J. Bot.* **54**: 2275-2290.
- Erans G.C. 1972. *The quantitative analysis of plant growth*. Blackwell Scientific Publ. Oxford.
- Fredericq S. and Hommersand M.H. 1989. Proposal of Gracilariaceae ord. nov. (Rhodophyta) based on analysis of the reproductive development of *Gracilaria verrucosa*. *J. Phycol.* **25**: 213-227.
- Fredericq S. and Hommersand M.H. 1989. Comparative morphology and taxonomic status of *Gracilariopsis* (Gracilariales, Rhodophyta). *J. Phycol.* **25**: 241-247.
- Gerwick W.H., Proteau P.J., Nagle D.J., Wise M.L., Zhi D.J., Bernart M.W. and Hamberg M. 1993. Biologically active oxylipins from seaweeds. *Hydrobiologia* **260/261**: 653-665.
- Goldstein M.E. 1973. Regeneration and vegetative propagation of the agarophyte *Gracilaria debilis* (Forsskål) Børgesen (Rhodophyceae). *Bot. Mar.* **16**: 226-228.
- Hori K., Miyazawa K. and Ito K. 1990. Some common properties of lectins from marine algae. *Hydrobiologia* **204/205**: 561-566.
- Hoyle, M.D. 1978. Reproductive phenology and growth rates in two species of *Gracilaria* from Hawaii. *J. Exp. Mar. Biol. Ecol.* **35**: 273-278.
- Hunt R. 1982. *Plant growth curves: The functional approach to plant growth analysis*. Edward Arnold, London.
- Jones W.E. 1959. The growth and fruiting of *Gracilaria verrucosa* (Hudson) Papenfuss. *J. Mar. Biol. Ass. U.K.* **38**: 47-56.
- Kim M.S., Lee I.K. and Boo S.M. 1993. Phenology and morphology on *Gracilaria verrucosa* (Rhodophyta) on the west coast of Korea: a statistical approach. *Jpn. J. Phycol.* **41**: 345-350.
- Kim Y.S., Choi H.G. and Nam K.W. 2001. Effects of light, desiccation and salinity for the spore discharge of *Gracilaria verrucosa* (Rhodophyta) in Korea. *J. Fish. Sci. Tech.* **4**: 257-260.
- Kim Y.S., Choi H.G., Kim H.G., Nam K.W. and Sohn C.H. 1998. Reproductive phenology of *Gracilaria verrucosa* (Rhodophyta) in Cheonsanpo near Pusan, Korea. *J. Fish. Sci. Tech.* **1**: 147-151.
- Kim Y.S., Choi H.G., Kim H.G., Nam K.W. and Sohn C.H. 2002. Temperature and light responses in growth of *Gracilaria verrucosa* (Rhodophyta) and its potential for mariculture in Korea. *J. Fish. Sci. Tech.* **5**: 108-113.
- Koh N.P. 1969. Fundamental observations on *Gracilaria* culture.

- Bull. Korean Fish. Soc.* **2**: 134-138 (in Korean with English abstract).
- Lee I.K. and Kang J.W. 1986. A check list of marine algae in Korea. *Korean J. Phycol.* **1**: 311-325.
- Lee Y. and Kang S. 2001. *A catalogue of the seaweeds in Korea*. Cheju National Univ. Press.
- Lee I.K., Kim M.S. and Boo S.M. 1995. A taxonomic appraisal of Korean *Gracilaria verrucosa* (Rhodophyta, Gracilariales). In: Abbott I.A. (ed.) *Taxonomy of economic seaweeds: With reference to some pacific species*. vol. 5. California Sea Grant College, Univ. California. pp. 213-222.
- Lignell A. and Pedersen M. 1989. Agar composition as a function of morphology and growth rate. Studies on some morphological strains of *Gracilaria secundata* and *Gracilaria verrucosa* (Rhodophyta). *Bot. Mar.* **32**: 219-227.
- McHugh D.J. 1991. Worldwide distribution of commercial resources of seaweeds including *Gelidium*. *Hydrobiologia* **221**: 19-29.
- McLachlan J. and Bird C.J. 1984. Geographical and experimental assessment of the distribution of *Gracilaria* species (Rhodophyta: Gigartinales) in relation to temperature. *Helgol. Meeresunters.* **38**: 319-334.
- Neushul M. 1990. Antiviral carbohydrates from marine red algae. *Hydrobiologia* **204/205**: 99-104.
- Noda H., Amano H., Arashima K. and Nisiziwa K. 1990. Antitumour activity of marine algae. *Hydrobiologia* **204/205**: 99-104.
- Ohmi H. 1958. The species of *Gracilaria* and adjacent waters. *Mem. Fac. Fish. Hokkaido Univ.* **6**: 1-66, with 10 Plates.
- Okamoto R., Hori K., Miyazawa K. and Ito K. 1990. Isolation and characterization of a new haemagglutinin from the red alga *Gracilaria buras-pastoris*. *Experientia* **46**: 975-977.
- Oliveira E.C. de and Alveal K. 1990. The mariculture of *Gracilaria* (Rhodophyta) for the production of agar. In: Akatsuka I. (ed.) *Introduction to applied phycology*. SPB Academic Publ. pp. 553-564.
- Penniman C.A., Mathieson A.C. and Emerich-Merich Penniman C. 1986. Reproductive phenology and growth of *Gracilaria tikvahiae* McLachlan (Gigartinales, Rhodophyta) in the Great Bay Estuary, New Hampshire. *Bot. Mar.* **29**: 147-154.
- Raju P.V. and Thomas P.C. 1971. Experimental field cultivation of *Gracilaria edulis* (Gmel.) *Silva. Bot. Mar.* **14**: 71-75.
- Renn D.W. 1990. Seaweeds and biotechnology-inseparable companions. *Hydrobiologia* **204/205**: 7-13.
- Steentoft M., Irvime L.M. and Bird C.J. 1991. Proposal to conserve the type of *Gracilaria*, nom. cons., as *G. compressa* and its lectotypification (Rhodophyta, Gracilariaceae). *Taxon* **40**: 663-666.
- von Westernhagen H. 1973. The natural food of the rabbitfish *Siganus oramin* and *S. striolata*. *Mar. Biol.* **22**: 61-73.
- von Westernhagen H. 1974. Food preference in cultured rabbitfishes (Siganidae). *Aquaculture* **3**: 109-117.
- Yamamoto H. 1978. Systematic and anatomical study of the genus *Gracilaria* in Japan. *Mem. Fac. Fish. Hokkaido Univ.* **25**: 97-152, with 49 Plates.
- Yoshida T. 1998. *Marine Algae of Japan*. Uchida Rokakuho Publishing Co.

Received 26 January 2005

Accepted 30 May 2005