

## Suppression Method for Torque Ripple of PM Synchronous Motor

Hiroyuki Yonezawa<sup>†</sup>, Katsunori Taniguchi<sup>\*</sup> and Hyun Woo Lee<sup>\*\*</sup>

<sup>†</sup>Fuji Electric FA Component & Systems CO. Ltd, Mie, Japan

<sup>\*</sup>Osaka Institute of Technology, Osaka, Japan

<sup>\*\*</sup>Kyungnam University, Korea

### ABSTRACT

A new modified trapezoidal modulating signal for a pulse width modulation (PWM) inverter suitable for a permanent magnet synchronous motor (PMSM) drive is proposed in this paper. A new modulating signal for the PMSM drive is determined by the characteristic torque ripple of the motor with various electro-motive force (EMF). The proposed modulating signal is able to decrease the torque ripple even if the motor has sinusoidal EMF or non-sinusoidal EMF. By using the proposed modulating signal, the system reduced the torque ripple as well as achieved the effective utilization of the DC supply voltage for the inverter. Many improvements are accomplished by the PWM strategy adapting the modified trapezoidal modulating signal without a change in hardware.

**Keywords:** PMSM, Torque ripple, Electro-motive force, Modified trapezoidal modulating signal

### 1. Introduction

Increasing the amplitude of the fundamental component in the output waveform of the inverter achieves an effective utilization of the DC power supply, reduces the rated capacity of the inverter elements and decreases the turn-on losses of the switching devices. This is accomplished by the PWM strategy without a change in hardware. In general, a change in software does not involve extra complexity or increase in price. Therefore, the improvements by mean of the PWM strategy are an important and significant matter. The output waveform in the inverter increases the amplitude of the fundamental

components as non-sinusoidal waves. AC motors driven by the non-sinusoidal PWM strategy generates the torque ripple. Therefore, the inverter for the motor drive generally improves the output voltage waveform by removing the low-order harmonics.

We have proposed a PWM strategy using the modified trapezoidal modulating signal suitable for induction motor drives<sup>[1]</sup>. A modified trapezoidal modulating signal for the induction motor drive is determined by reducing the torque ripple of the motor. By using the proposed modulating signal, the system reduced the torque ripple as well as achieved the effective utilization of the DC supply voltage for the inverter. Many improvements are accomplished by the PWM strategy while adapting the modified trapezoidal modulating signal without a change in hardware. Moreover, a pulse amplitude modulation (PAM) inverter using modified trapezoidal modulating signal has been proposed<sup>[2,3]</sup>. The PAM inverter for

Manuscript received May 17, 2005; revised August 23, 2005

<sup>†</sup>Corresponding Author: yonezawa-hiroyuki@fujielectric.co.jp  
Tel: +81-593-83-8193, Fax: +81-593-83-8430, Fuji Ele., Japan

<sup>\*</sup>Osaka Institute of Technology, Japan

<sup>\*\*</sup>Kyungnam University, Korea

induction motor drive has several advantages [2,4].

In this paper, a new modified trapezoidal modulating signal suitable for PMSM drive is proposed. A new modified trapezoidal modulating signal for the PMSM drive is determined by characteristic torque ripple of the motor. If the PMSM with a sinusoidal EMF is driven by a sinusoidal PWM inverter, the motor does not generate torque ripple but the effective utilization of the magnetic flux is poor. Although the PMSM with a trapezoidal EMF is improved in respect to the utilization of magnetic flux, the motor generates torque ripple even if the motor is driven by the sinusoidal PWM inverter. The proposed new modified trapezoidal modulating signal is able to decrease the torque ripple even if the motor has sinusoidal EMF or non-sinusoidal EMF. The new PWM strategy using the proposed modulating signal makes a great improvement in the characteristics in the three-phase PWM inverter for the PMSM drive. The characteristics and advantages of the new system are confirmed by theoretical analysis, simulation by modeling the system and experiments.

## 2. Harmonic Torque Analysis of PMSM

The torque  $\tau$  of the PMSM is given by

$$\tau = \frac{P_m}{\omega_m} = \frac{e_u i_u + e_v i_v + e_w i_w}{\omega_m} \quad (1)$$

where,  $P_m$  is motor output power,  $\omega_m$  is mechanical angular velocity of a rotor,  $e_u, e_v, e_w$  are EMF of  $u, v,$  and  $w$  phase,  $i_u, i_v, i_w$  are armature current of  $u, v,$  and  $w$  phase [5-7]

This paper describes the PMSM of a non-salient type whereby a d-axis inductance is equal to a q-axis inductance. The PMSM is a surface permanent magnet synchronous motor (SPM). If the armature current and the EMF of the PMSM are the same phase angle, the motor performs more efficient drives. In this condition, the motor output power  $P_m$  can be expressed by the following equation.

$$P_m = \sum_{m=0}^{\infty} \sum_{n=0}^{\infty} k_{mn} E_m I_n \quad (2)$$

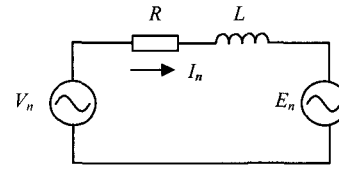

Fig. 1 Equivalent circuit of the PMSM (per phase)

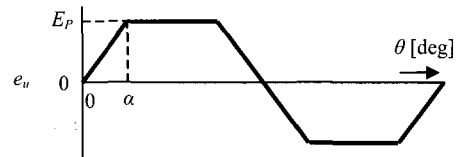

Fig. 2 Trapezoidal electro-motive force

$$k_{mn} = \cos(m-n)\omega_e t \left\{ \frac{1}{2} + \cos \frac{2}{3}(m-n)\pi \right\} - \cos(m+n)\omega_e t \left\{ \frac{1}{2} + \cos \frac{2}{3}(m+n)\pi \right\}$$

where,  $m=6k\pm 1(k=0,1,2,\dots,m\neq -1)$ ,  $n=6l\pm 1(l=0,1,2,\dots,n\neq -1)$ ,  $E_m$  is  $m$ -th harmonics component amplitude of EMF,  $I_n$  is  $n$ -th harmonics component amplitude of armature current and  $\omega_e$  is electric angular velocity of a rotor. When the PMSM with the non-sinusoidal EMF is driven by the non-sinusoidal wave voltage, the output torque has harmonics including 6 times components of the inverter output frequency. If the torque due to the 6th harmonic torque could be eliminated, it would be possible to substantially reduce torque ripple. From (1) and (2), the 6th harmonic torque is obtained [7-9].

$$\tau_6 = \frac{3}{2} \frac{1}{\omega_m} \{ E_1(I_7 - I_5) + (E_7 - E_5)I_1 + E_5 I_{11} + E_{11} I_5 + E_7 I_{13} + E_{13} I_7 + E_{11} I_{17} + E_{17} I_{11} + \dots \} \quad (3)$$

Fig. 1 shows the equivalent circuit of the inverter-fed PMSM. Armature current  $I_n$  is calculated from the armature voltage  $V_n$ , the EMF  $E_n$ , and the motor impedance.  $I_n$  is given by

$$I_n = \frac{V_n e^{jn\delta} - E_n}{R + jn\omega_e L} \quad (4)$$

where,  $\delta$  is the phase difference of the armature voltage  $V_n$  and the EMF  $E_n$ .

When the motor EMF is the trapezoidal waveform as shown in Fig. 2, the amplitude  $E_n$  of the  $n$ -th component of the EMF is

$$E_n = \frac{4E_p}{n^2\pi\alpha} \sin(n\alpha) \quad (5)$$

where,  $n=1,3,5,\dots$ ,  $E_p$  is the amplitude of trapezoidal wave and  $\alpha$  is the angle of incline part of the trapezoidal wave.

The voltage equation of PMSM with a non-sinusoidal EMF wave is expressed by

$$\begin{bmatrix} v_d \\ v_q \end{bmatrix} = \begin{bmatrix} R + pL & -\omega_e L \\ \omega_e L & R + pL \end{bmatrix} \begin{bmatrix} i_d \\ i_q \end{bmatrix} + \begin{bmatrix} e_d \\ e_q \end{bmatrix} \quad (6)$$

$$\begin{bmatrix} e_d \\ e_q \end{bmatrix} = \frac{2}{3} \begin{bmatrix} \cos\omega_e t & \cos\left(\omega_e t - \frac{2}{3}\pi\right) & \cos\left(\omega_e t - \frac{4}{3}\pi\right) \\ -\sin\omega_e t & -\sin\left(\omega_e t - \frac{2}{3}\pi\right) & -\sin\left(\omega_e t - \frac{4}{3}\pi\right) \end{bmatrix} \begin{bmatrix} e_u \\ e_v \\ e_w \end{bmatrix}$$

where,  $v_d, v_q$  are d-axis and q-axis component of the armature voltage,  $i_d, i_q$  are d-axis and q-axis components of the armature current,  $e_d, e_q$  are d-axis and q-axis component of an EMF,  $R$  is the stator resistance and  $L$  is the stator inductance. Regardless of the position of a rotor, the  $L$  is constant [5,10]. If  $i_d$  is equal to 0, the armature current and EMF will take the same phase angle. Substituting  $i_d=0$  into (6), ignoring a differential term, line-to-line voltage  $V_l'$  in a steady state is obtained by

$$V_l' = \sqrt{v_d^2 + v_q^2} \quad (7)$$

where  $v_d = -\omega_e L i_q$ ,  $v_q = R i_q + e_q$ .  $V_n$  of (4) is obtained by giving voltage so that the amplitude of the fundamental component of the armature voltage is equal to  $V_l'$  of (7).  $\delta$  is given by

$$\delta = \tan^{-1} \frac{\omega_e L i_q}{R i_q + e_q} \quad (8)$$

The 6th harmonic torque  $\tau_6$  is calculated by substituting the motor parameters into the above equation.

### 3. Characteristics of the PMSM

#### 3.1 A Conventional PWM Strategy

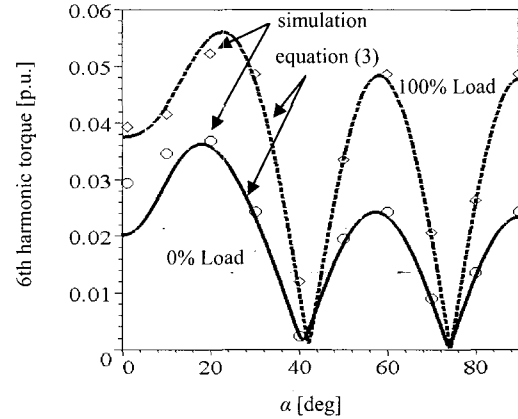

Fig. 3 Amplitude of 6th harmonic torque as a function of  $\alpha$ .

Table 1 Specifications of PMSM

Rated power	1.5kW
EMF at rated speed	115Vrms
Number of pole pairs	3
Rated frequency	100Hz
Rated current	7.5A
Stator inductance	4.8mH
Stator resistance	0.775 $\Omega$
Moment of inertia	0.015kgm <sup>2</sup>
Rated torque	7.16Nm

In the sinusoidal PWM inverter fed PMSM, the motor with sinusoidal EMF generates constant torque. To obtain the sinusoidal EMF of the PMSM, the motor is adapted to the distributed winding, the skew slot and the design of the shape of a permanent magnet. Therefore, PMSMs widely use non-sinusoidal EMFs because sinusoidal EMFs cause an increase in cost and a decrease in EMF.

Typical parameters of low power PMSMs are listed in Table 1. Fig. 3 shows the 6th harmonic torque obtained by using the parameters of Table 1. A supply voltage is a sinusoidal wave and the output frequency is 5Hz. The circle and diamond marks in Fig. 3 show the simulation results. A simulation block diagram is shown in Fig. 4. To obtain the armature voltage by (7), the d-axis component of the armature current is kept at  $i_d=0$ . The motor output power  $P_m$  divided by the EMF  $e_q$  gives the torque current  $i_q$ .

Simulation results concurred with the calculated line. From Fig. 3, it is found that the PMSM with trapezoidal EMF of  $\alpha=42$  degree can reduce the 6th harmonic torque. Additionally, point  $\alpha$  increases torque ripple even if the motor is driven by the sinusoidal PWM inverter.

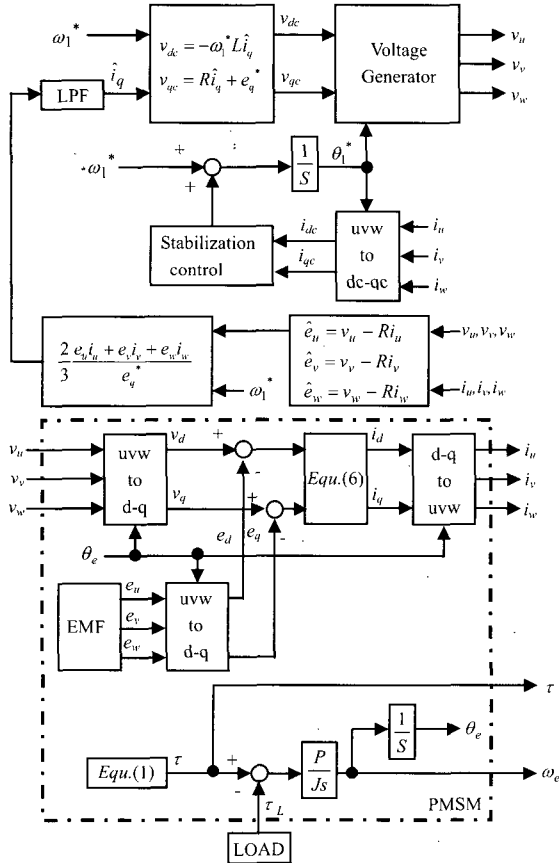

Fig. 4 Simulation block diagram of the motor-torque ripple

### 3.2 Proposed PWM Strategy

#### 3.2.1 Modified trapezoidal modulating signal

Fig. 5 shows the generation principle of the PWM pulses for the power inverter to reduce the torque ripple of the PMSM. In Fig. 5(a), a modified trapezoidal modulating signal is obtained by superposing a rectangular wave on the specific trapezoidal wave whose flat portion is 120 degrees.  $\gamma$  is a ratio of the trapezoidal waveform to the rectangular waveform superposed on the trapezoidal waveform. A modified trapezoidal waveform becomes a rectangular waveform when  $\gamma=1$ , and the waveform is a trapezoidal wave when  $\gamma=0$ .

Fig. 5(e) shows the PWM output waveform that

includes the fundamental component, higher-order harmonics and sidebands of the carrier frequency<sup>[1,3]</sup>. Amplitude of the fundamental component and the higher-order harmonics can be obtained by analyzing the waveform, as follows;

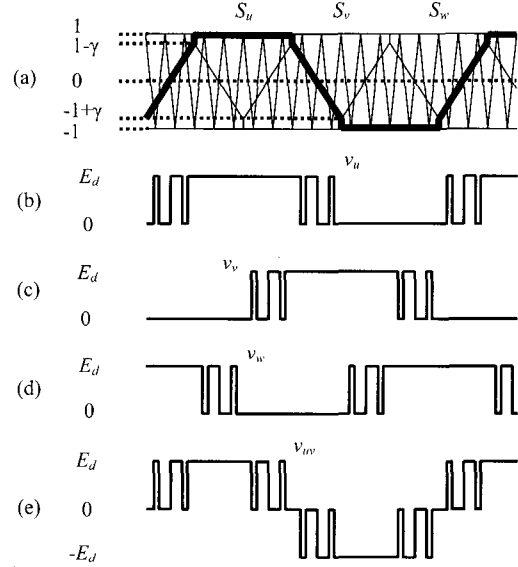

Fig. 5 Generation principle of PWM pulses

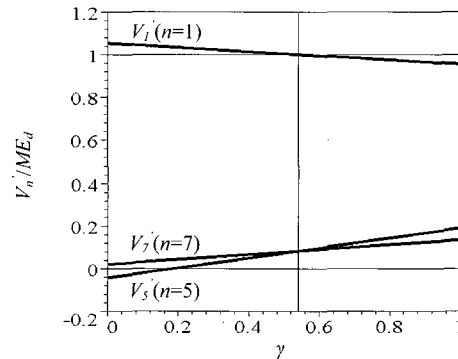

Fig. 6 Major frequency components included in the output PWM voltage

$$V_n' = ME_d \left\{ \frac{4\gamma}{n\pi} \cos \frac{n}{6} \pi + \frac{24(1-\gamma)}{n^2 \pi^2} \sin \frac{n}{6} \pi \right\} \cos \frac{n}{6} \pi \quad (9)$$

where,  $n=6k\pm1$  ( $k=0,1,2,\dots,n\neq-1$ ),  $E_d$  is a DC link voltage. As seen in (9), the amplitude value  $V_n'$  of the fundamental component and the harmonic content of the PWM output voltage is the function of  $\gamma$ . Fig. 6 shows major frequency

components included in the output PWM voltage as a function of  $\gamma$ .

### 3.2.2 Characteristics of the PMSM with a sinusoidal EMF

In the PWM inverter using a modified trapezoidal modulating signal fed PMSM, the motor with sinusoidal EMF is investigated. Fig. 7 shows the relation between  $\gamma$

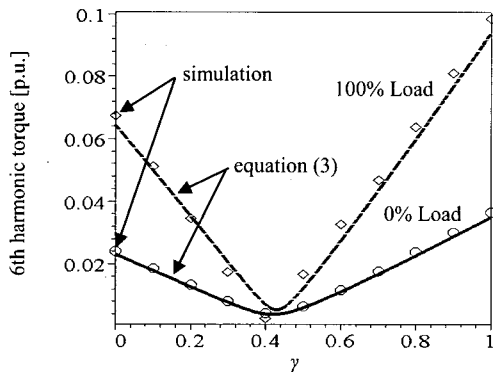

Fig. 7 Amplitude of 6th harmonic torque as a function of  $\gamma$

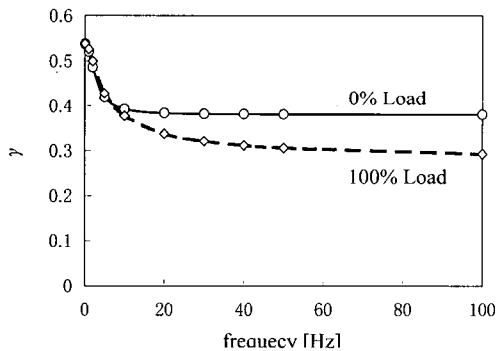

Fig. 8  $\gamma$  of minimum 6th harmonic torque

and the 6th harmonic torque. Output frequency is 5Hz. As seen in Fig. 7, minimum amplitude of 6th harmonic torque occurs at  $\gamma = 0.42$ . The fundamental component of the output voltage for the modified modulating signal of  $\gamma = 0.42$  increased about 17% more than that of the PWM strategy by a sinusoidal modulating signal.

Fig. 8 shows the  $\gamma$  values which occur at the minimum 6th harmonic torque for various output frequencies of the inverter. The  $\gamma$  values, which yield minimum 6th harmonic torque, are decided by the output frequency and load conditions. Since the pattern of optimal  $\gamma$  can be calculated in advance, it is easy to control it by using the table of software.

### 3.2.3 Characteristics of the trapezoidal EMF

Fig. 9 shows the relation between  $\gamma$  and the 6th harmonic torque in three EMF cases. The  $\alpha$  values of the trapezoidal EMF are 45degrees, 40degrees and 35degrees. The output frequency of the inverter is 5Hz.

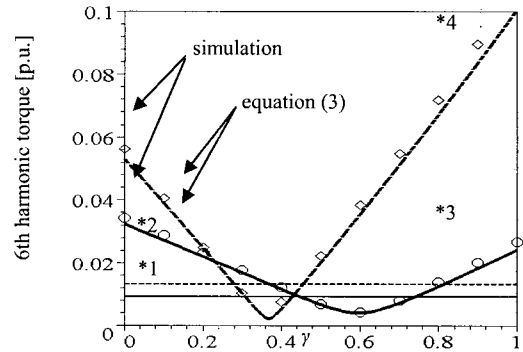

(a) Trapezoidal EMF,  $\alpha=45$ degrees

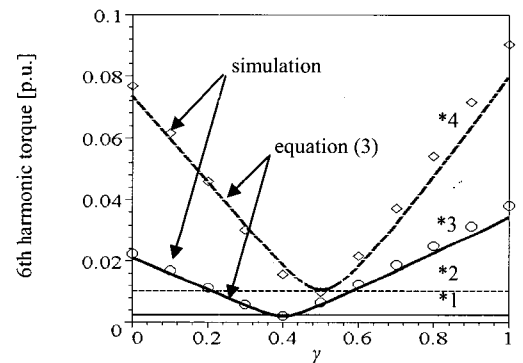

(b) Trapezoidal EMF,  $\alpha=40$  degrees

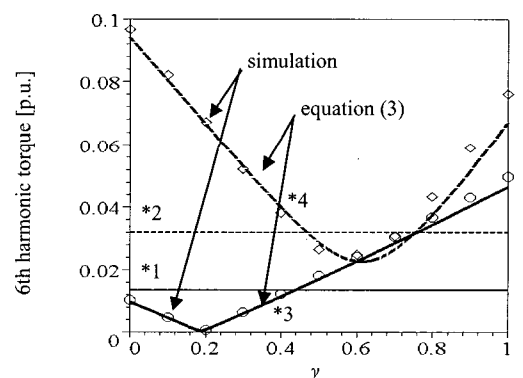

(c) Trapezoidal EMF,  $\alpha=35$  degrees

Fig. 9 6th harmonic torque

\*1 Sinusoidal power supply (0% load), \*2 Sinusoidal power supply (100% load), \*3 Modified trapezoidal (0% load), \*4 Modified trapezoidal (100% load)

When the PMSM with trapezoidal EMF is driven by sinusoidal voltage, the 6th harmonic torque is generally larger than the modified trapezoidal voltages for  $\gamma$  occurring minimum values. Therefore, if the PMSM with trapezoidal EMF are driven by the modified trapezoidal

line-to-line EMF voltage is 115V. The amplitude of the 5th harmonic voltage of the EMF is 2.4 % of the fundamental component, and the 7th harmonic is 0.8%.

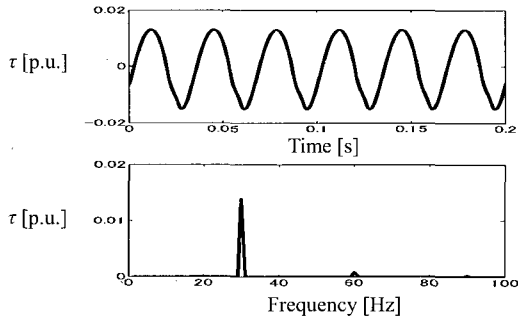

Fig. 10 Simulation results of the sinusoidal voltage

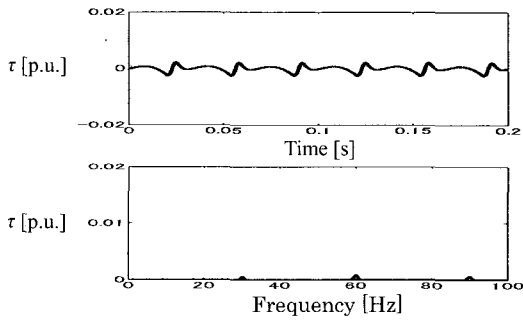

Fig. 11 Simulation results of the proposed voltage ( $\gamma=0.19$ )

voltage, the harmonic torque can be decreased by changing the  $\gamma$  according to  $\alpha$  of a trapezoidal wave.

Fig. 10 shows a simulated torque waveform and its frequency spectrum when the PMSM with  $\alpha = 35$ degrees trapezoidal EMF is driven by a sinusoidal voltage, and Fig. 11 is a waveform and spectrum when the PMSM with  $\alpha = 35$ degrees trapezoidal EMF is driven by a modified trapezoidal voltage of  $\gamma=0.19$ . The amplitude of the 6th harmonic torque for sinusoidal voltage is 1.4%, and for modified trapezoidal voltage is only 0.1%.

### 4. Experimental Results

The principal parameters of the tested PMSM are listed on Table 1.

Fig. 12 shows the EMF waveform (line-to-line voltage) of the PMSM. Where a rated speed is 2000r/min and

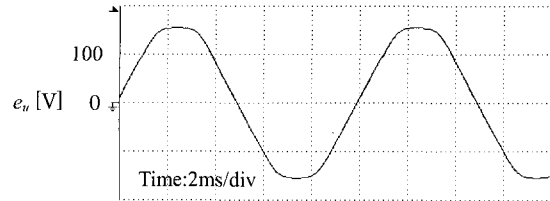

Fig. 12 EMF waveform (line-to-line)

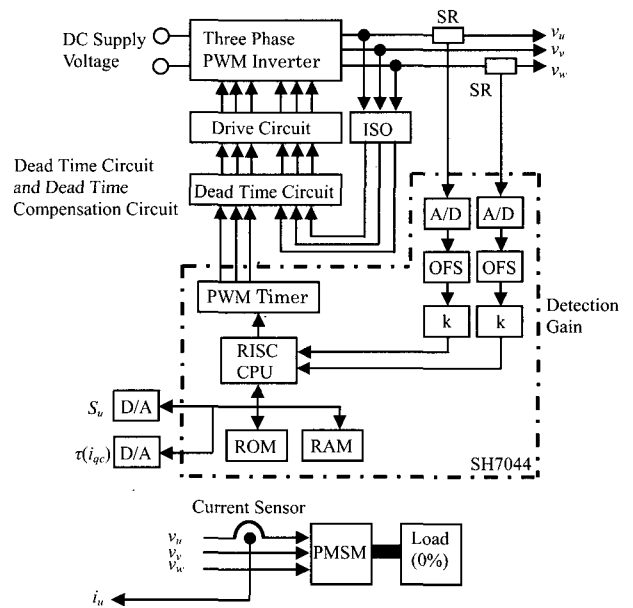

Fig. 13 Experimental Circuit

SR=Shunt Resistance and Isolation Amplifier  
ISO= Isolation Circuit

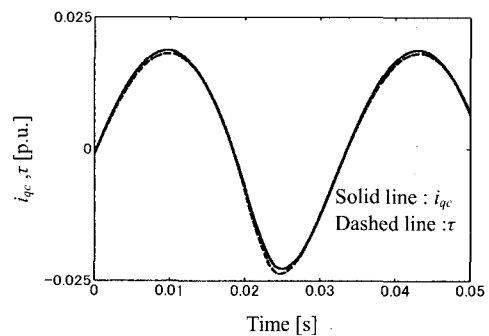

Fig. 14 Comparison of  $i_{qc}$  and torque

Fig. 13 shows a system configuration for the experiments. “Dead Time Circuit” is shown in Fig.13. The dead time influence of the inverter is very small because

of a voltage feedback system. The carrier frequency of the PWM inverter is 2kHz and the motor condition is no-load. The OFS is the offset correction of the detected current. In general, it is difficult to measure the harmonic torque directly. Fig. 14 shows the simulation wave of the torque current  $i_{qc}$  and the torque. The voltage of the PMSM is a sinusoidal wave and the EMF is a trapezoidal wave with  $\alpha = 32$ degrees. The output frequency is 5Hz and the load is 0%. The torque agrees well with the torque current  $i_{qc}$ . Therefore, in this experiment, the harmonic torque is measured by using torque current  $i_{qc}$ . In Fig. 13,  $S_u$  is a modulating signal,  $\tau(i_{qc})$  is the qc-axis current of a control-coordinates axis. And it is substituted for the torque.

Fig. 15 shows the experimental waveforms for a sinusoidal modulating signal, and Fig. 16 is the experimental waveforms of a modified trapezoidal modulating signal ( $\gamma=0.4$ ). In Fig. 15 and Fig. 16, (d) is the frequency spectrum of  $\tau(i_{qc})$ .

For the PWM strategy using the sinusoidal modulating signal of Fig. 15, the 6th harmonic torque has appeared clearly in a torque waveform and its frequency spectrum. The harmonic torque is reduced in the PWM strategy by the modified trapezoidal modulating signal of Fig. 16.

Fig. 17 shows the amplitude of the 6th harmonic torque for various  $\gamma$  of a modified trapezoidal signal. For the modified trapezoidal of  $\gamma=0.4$ , the 6th harmonic torque is reduced about 1% compared with the sinusoidal modulating signal. The experimental results are in agreement with the analysis output Fig. 9 (b) in case  $\alpha$  is 40 degrees.

As a result, the modified trapezoidal modulating signal is suitable for the PMSM with a sinusoidal EMF. In the PMSM with a non-sinusoidal EMF, the proposed method is still more effective.

### 5. Conclusions

A new modified trapezoidal modulating signal suitable for the PMSM drive has been proposed. The proposed new modified trapezoidal modulating signal is able to decrease torque ripple even if the motor has sinusoidal EMF or non-sinusoidal EMF. By using the proposed modulating signal, the system reduced torque ripple as well as

achieved the effective utilization of the DC supply voltage for the inverter. Many improvements are accomplished by the PWM strategy which adapts the modified trapezoidal modulating signal without a change in hardware.

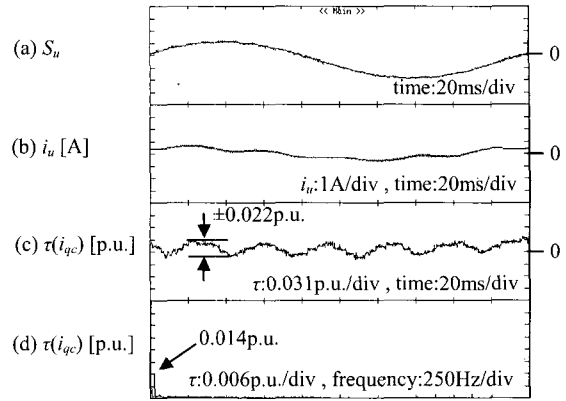

Fig. 15 Experimental Waveforms (Sin modulating signal)

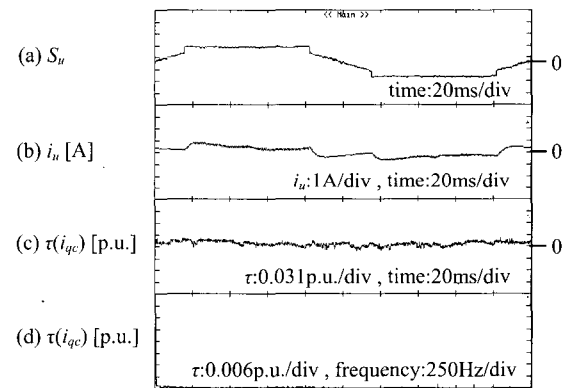

Fig. 16 Experimental Waveforms (Modified trapezoidal modulating signal,  $\gamma=0.4$ )

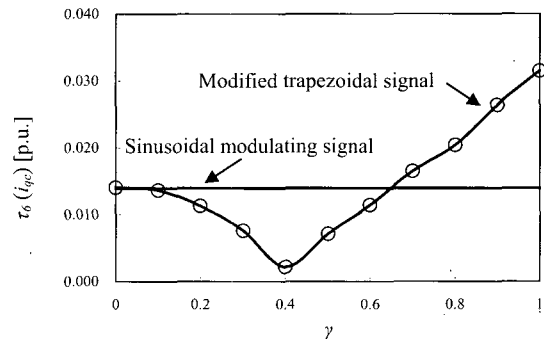

Fig. 17 Relation between  $\gamma$  and 6th harmonic torque (Experimental value)

The characteristics and advantages of the new system have been confirmed by theoretical analysis, simulation by modeling the system and experiments for the drive system of PMSM.

### References

- [1] K. Taniguchi, M. Inoue, Y. Takeda, S. Morimoto, "A PWM Strategy for Reducing Torque-Ripple in Inverter-Fed Induction Motor", *IEEE Trans. on Industry Applications*, Vol.30, No.1, January /February, pp.71-77(1994).
- [2] K. Taniguchi, T. Morizane, N. Kimura, H. Lee, "A PAM Inverter System with High Power Factor for Induction Motor Drive", *ICPE'95, Seoul*, pp.641- 646(1995).
- [3] Taniguchi, Kimura, Morizane, Takeda, Morimoto, Sanada, "Novel PAM Inverter System for Induction Motor Drive", *International Journal of Electronics, Special issue-POWER ELECTRONICS AND DRIVE SYSTEMS*, Vol.80, No.2, Feb., pp143/153(1996-2).
- [4] Taniguchi, Matano, Morizane, Kimura "PAM Inverter System with Power Factor Corrected Converter", *Trans. On IEE Japan*, Vol.117-D, No9, pp.1077-1084 (1997) (in Japanese).
- [5] D.C. Hanselman, "Minimum Torque Ripple, Maximum Efficiency Excitation of Brushless Permanent Magnet Motors", *IEEE Trans. on Ind. Elec.*, Vol.41, No.3, pp.292-300 (1994).
- [6] E. Favre, L.Cardoletti, M.Jufer, " Permanent-Magnet Synchronous Motors: A Comprehensive Approach to Cogging Torque Suppression", *IEEE Trans. on Ind. Appl.*, VOL29, No6, pp.1141-1149 (1993).
- [7] H. Le-Huy, R. Perret, R. Feuillet, "Minimization of Torque Ripple in Brushless DC Motor Drives", *IEEE Trans. on Ind. Appl.*, Vol.1A-22, No.4, pp.748-755 (1986).
- [8] F. Piriou, A. Razek, R. Perret, H. Le-Huy, "Torque Characteristics of Brushless DC Motors with Imposed Current Waveform", *IEEE IAS Meet.*, 1, pp.176-181 (1986).
- [9] R. Carlson, A. A. Tavares, J. P. Bastos, M. L-Mazenc, "Torque Ripple Attenuation in Permanent Magnet Synchronous Motors", *IEEE IAS Meet.*, pp.57-62 (1989).
- [10] C. Marchand, A. Razek, " Optimal Torque Operation of Digitally Controlled Permanent Magnet Synchronous Motor Drives", *IEE Proc. B*, Vol.140, No3, pp.232-240 (1993).



**Hiroyuki Yonezawa** was born in Hyogo Prefecture, Japan in 1961. He received B.S. and M.S. degrees in electrical engineering from Osaka Institute of Technology, Osaka, Japan, in 1984 and 1986, respectively. He is currently the manager of the Inverter Design Section, Design Department, Inverter Value Engineering Center of Fuji Electric FA Components & System Co., Ltd., Mie, Japan. His research interests are in the areas of PWM inverters and its application to motor control. Mr. Yonezawa is a Member of the Institute of Electrical Engineers of Japan and the Japan Institute of Power Electronics.



**Katsunori Taniguchi** was born in Nagasaki Prefecture, Japan, in 1943. He received B.S. degrees in electrical engineering from Osaka Institute of Technology, Osaka, Japan, in 1966 and M.S. and Ph.D. degrees from the University of Osaka Prefecture, Osaka, Japan, in 1970 and 1974, respectively. Since 1966, he has been with the Department of Electrical Engineering, Osaka Institute of Technology, where he is currently a professor. He was general chairperson of the PCC-Osaka 2002 and president of the Japan Institute of Power Electronics in 2003-2005. He is engaged in research on PWM inverters and its application to motor control. Dr. Taniguchi is a member of IEEJ, IEEE Senior, EPE and JIPE.



**Hyun-Woo Lee** He received a B.E. degree in electrical engineering from Dong-A University, Pusan, Korea, in 1979 and received an M.S. degree in electrical engineering from Yeungnam University, Kyungbook, Korea, in 1984 and a Ph.D. degree in electrical engineering from Dong-A University, Pusan, Korea, in 1992. Since 1985 he has been with the Division of Electrical Electronics Engineering, Kyungnam University, Masan, Korea, where he is a professor. He is interested in the area of power electronics and new power generation systems. He is a member of the KIEE and IEEE. He is also the director of the Electric Energy Saving Research Center (EESRC) at Kyungnam University.