

# A High-speed Miniature Screening Gaschromatograph with Flame Ionization Detector

**Rahul Banik\*, Dong-Yeon Lee, Dae-Gab Gweon**

*Department of Mechanical Engineering,*

*Korea Advanced Institute of Science and Technology (KAIST),*

*373-1, Kusung-Dong, Yusong-Gu, Daejeon 305-701, Korea*

The combination of Gas chromatography (GC) for separation and Flame Ionization Detection (FID) for detection and identification of the components of a mixture of compounds is a fast and strongly proved method of analytic chemistry. The objective of this research was to design a combined High-speed miniature screening Gas chromatograph along with a Flame Ionization Detector for quick, quantitative and qualitative analysis of gas components. This combined GC-FID system is suitable to detect the volatile and semi-volatile hydrocarbons present in a gas mixture. The construction made it less expensive, easy to use and movable. The complete gas path was developed. On/off valves, temperature and flow sensors and their interface electronics were used for controlling purpose. A Microcontroller was programmed to measure the temperature and gas flow using the sensors and to control and regulate them using the electronics and valves. A pocket PC with its touch screen served as a user interface for the system. Software was developed for the pocket PC, which makes the communication possible with the Microcontroller. The system parameters can be indicated in the Pocket PC as simple text and also the analysis result can be displayed.

**Key Words :** Gaschromatograph, Flame Ionization Detector, Microcontroller, Pocket PC

## 1. Introduction

Environmental protection is one of the most important issues of modern world. In the exhaust gases of automobiles, burnt and unburned components of hydrocarbons are present that is one of the main causes of environmental pollution (Ryu and Oh, 2003). To regulate amount of hydrocarbons present in these gases, we need a quick, accurate detection and fast screening.

A gaschromatograph is used to separate the components mixture. The GC-oven size is minia-

turized and the temperature is controlled such that fast heating is possible. Using fast ionization, the Flame Ionization Detector detects the separated gases. So the combined system is suitable for fast screening and detection.

To control the temperature and gas flow rate, a Microcontroller is necessary which can be programmed to control and regulate the flow rate and the temperature of such a combined GC-FID system. A pocket PC can make the system really movable and very easy to use. It can provide the user interface and communication interface for the microcontroller.

The goal of this work is to build a prototype GC-FID system for fast screening and detection. It is automated and is also mobile (Rahul Banik, 2003).

---

\* Corresponding Author,

**E-mail :** rahulbanik@kaist.ac.kr

**TEL :** +82-42-869-3265; **FAX :** +82-42-869-5225

Department of Mechanical Engineering, Korea Advanced Institute of Science and Technology (KAIST), 373-1, Kusung-Dong, Yusong-Gu, Daejeon 305-701, Korea. (Manuscript Received December 27, 2004; Revised October 10, 2005)

## 2. Gas chromatograph

A Gas chromatograph is used for the quick, quantitative and qualitative analysis of organic compounds. The main tool of Gas chromatography is a Gas chromatograph (GC), a temperature controlled oven designed to hold and heat GC column. The GC column is a 1-150 m coiled capillary tube made of glass, silica or metal with typical internal diameter of 0.25-0.75 mm. It has an internal coating of either a viscous liquid such as Carbowax, Phenyl-Methyl or a wall-bonded organic material. This phase is called stationary phase.

The components to be separated are injected into the GC column and are carried by carrier gas. This phase is called mobile phase. When the sample in the carrier gas is allowed to pass through the GC column, absorptive interaction between the two phases leads to a differential separation of the gas mixtures depending on the retention time (time to remain inside the column) of different gases (Ernst Kenndler, 1999). Fig. 1 gives an example of a chromatogram (a plot of gas molecule intensity with respect to time) with three different colored peaks indicating three gas components coming out of the GC column at different time.

### 2.1 Theory of component separation in a GC column

Different components have different retention times depending on the following factors (URL : [www.plant-hormones.info/retentionindex.htm](http://www.plant-hormones.info/retentionindex.htm)):

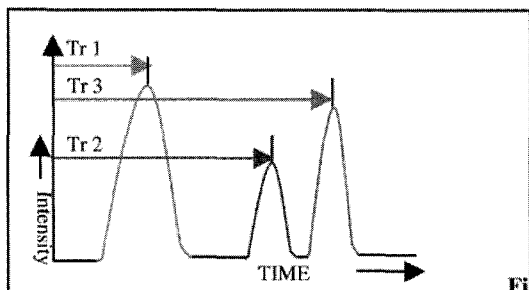

Fig. 1 Example of a gas chromatogram

- (1) Polarity of the stationary phase
- (2) Temperature
- (3) Flow or head pressure
- (4) Inner diameter and thickness of GC column
- (5) Carrier gas flow
- (6) The substance itself (polarity, form and reactivity).

## 3. Flame Ionization Detector

A FID (Flame Ionization Detector) is one of the most popular detectors in use today for the analysis of organic components especially hydrocarbons. It is less expensive and has an easy-to-use construction.

### 3.1 Operating principle of the FID

Here the carrier gas effluent from the GC column is mixed with hydrogen, and then routed through an unbreakable stainless steel jet. The hydrogen mixed with air is used to support a diffusion flame at the jet's tip. Most of the analyte molecules when inserted in this flame, charged particles or ions are generated, either by thermal ionization or oxidation. Only the negative ions are collected by a positively charged collector electrode which is connected, to an electrometer amplifier to produce an equivalent analog electric voltage signal.

## 4. Materials and Methods

### 4.1 The Halogen lamp GC-Oven

A fast gas chromatography requires high heating rate of the GC column and fast cooling of the GC oven. So the GC oven must be small with good thermal isolation and needs a heating source with a high heating rate. The small dimensions of the oven are realized by having an inner curvature diameter of 52 mm and length of 70.9 mm. For thermal isolation, high temperature sustainable polyimide foam material is used (maximum temperature range 250 to 300°C) inside of which is pasted with radiation reflective aluminum foil using special silicon metal paste. As a heat source, commercial low-voltage halogen

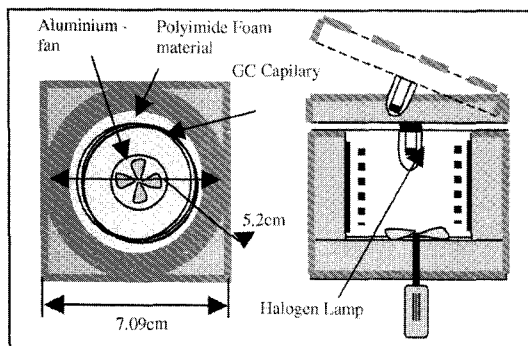

Fig. 2 Main parts of the GC oven

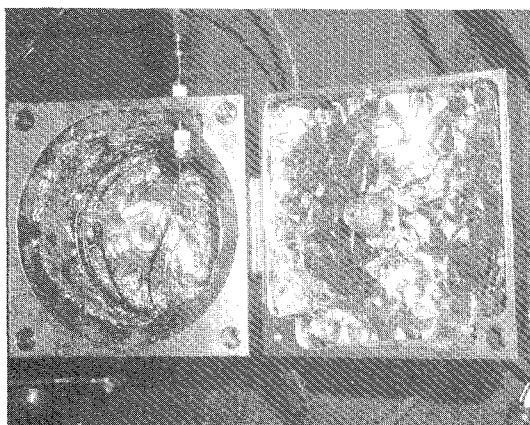

Fig. 3 GC oven with its cover open

lamp (24V/20W) is used. For cooling purpose, a light Al fan is mounted. Also it is possible to open the upper cover of the GC oven controlled by using a servo motor.

The most important area is in the edge of the oven where the metal capillary lies and where the temperature has to be homogeneous to obtain good separation of the gas mixtures. Figs. 2 and 3 shows the dimensions and side view of the oven. A NiCr-Ni thermo element measures the temperature. To control the heating, light intensity is also measured along with the temperature.

#### 4.2 The SRI FID

The FID used in this experiment is from the company SRI. It uses a ceramic igniter whose glow wire is made of platinum having resistance of around 1.3 ohm. The glow wire needs around 7V and 2-3A current to glow red-hot. The igniter

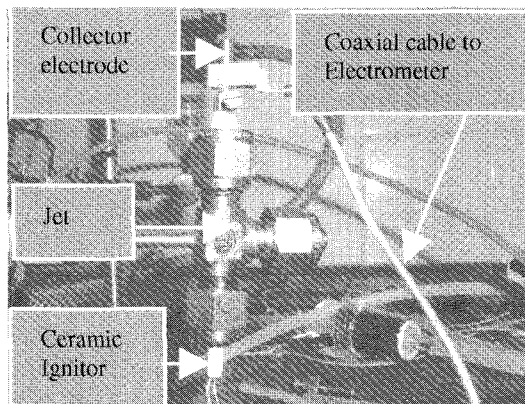

Fig. 4 SRI FID with collector cable and igniter

is positioned perpendicular to the stainless steel jet and does not penetrate the flame. Opposite to the flame is the collector electrode which is a positively charged metal tube used to collect the negative ions.

#### 4.3 Operating the FID

To operate the detector, the flame needs to be ignited. Typically the ratio of air and hydrogen is 10 : 1 respectively. But since hydrogen is used also as a carrier gas, the three flows (hydrogen as carrier, hydrogen for FID and air for FID) were optimized. To light the flame, the current control knob of the igniter is rotated until the igniter glows dull orange. A noticeable "report" is heard when the hydrogen detonates and the flame ignites. After ignition, the current can be reduced or can be set off.

#### 4.4 System structure

Figure 5 below shows the block diagram of the complete system structure.

#### 4.5 The Gas flow circuit

The complete gas flow circuit was realized connecting the regulators and the on-off valves to control and regulate the gas flow, the flow sensors to measure the flow and active charcoal filter to clear the ambient air before passing it through the pump.

In this system, hydrogen is used as carrier as well as gas support for the FID flame. Hydrogen has better heat conductivity and is lighter com-

pared to other conventional carrier gases. Moreover hydrogen is necessary to support the flame of the FID. So hydrogen is more preferable as a carrier gas for this system. There is possibility of explosion when it comes in contact with air and a spark occurs. So it is necessary to take precautionary measure to avoid explosion. To prevent leaks in system, metal capillary is used along with shweglocks.

Figure 6 above shows two ways of hydrogen gas flow, one as carrier gas for the sample and the other as the gas supply for the FID. Two AWM3150 micro bridge mass airflow sensors from company Honeywell are used to measure the gas flows. The AWM 3150 flow sensors are calibrated for air. They have been calibrated for Hydrogen. Air supply for the FID comes from a voltage-regulated pump capable of providing flow rates from 50 to 1000 ml/min regulated by Microcontroller. Flow measurement of air is done by Micro bridge mass airflow sensor AWM3300. An active charcoal filter is used to filter ambient air before passing it through the pump.

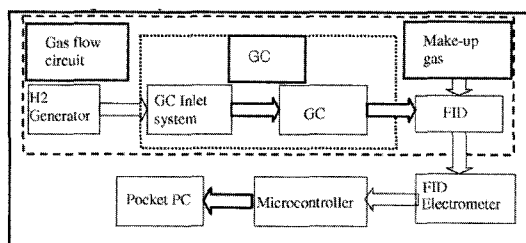

Fig. 5 Block diagram of the complete system

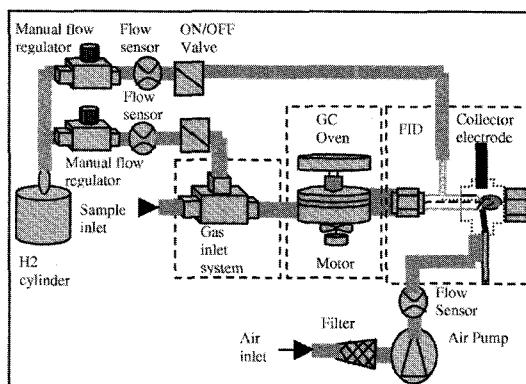

Fig. 6 The Gas Flow circuit

## 4.6 Hardware

Microcontroller plays the central role supported by the control and regulation electronics. The main parts are :

- Voltage supply,
- FID Electrometer amplifier,
- Microcontroller board,
- Control and regulation electronics,
- Communication interface and
- Pocket PC.

### 4.6.1 Voltage Supply

Voltage supply used is a +24 V/−12 V dual power supply. Required voltage supplies for different electronic circuit board are as follows :

- FID Electrometer : +12 V/−12 V,
- Control, regulation electronics : +12V and +5V,
- Micro controller board : 10-12 V,
- Flow sensors : 10 V.

A regulated voltage supply was developed.

### 4.6.2 FID Electrometer circuit

The output of the positively charged collector electrode of the FID is in the range of Pico Amps. A current to voltage amplifier called Electrometer circuit was used for amplification. It is a highly precise amplifier with two cascaded stages. Fig. 7 below shows the amplifier circuit.

The Electrometer circuit consists of two operational amplifiers. A SDS relay connects the input of the FID Electrometer to the positive terminal

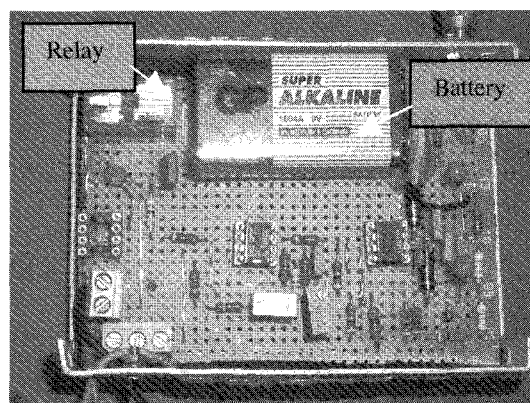

Fig. 7 The FID Electrometer circuit

of the 9V battery by using the normally-open contact. The relay is controlled by the digital output from the Microcontroller. Microcontroller checks whether the temperature of the FID exceeds  $100^{\circ}\text{C}$  so that there is no short circuit occurs due to the water vapor condensation and then it connects the electrode to the battery. The battery is used to keep the electrode at a positive potential. The current is then amplified and converted to equivalent voltage and then connected to the ADC (Analog to Digital Converter) of the Microcontroller. The noise margin of this Electrometer circuit is around 250 mV peak to peak. The whole circuit is housed in a grounded casing to make it more immune to noise.

#### 4.6.3 Micro controller Board

The Microcontroller plays the central role for controlling, regulating and communicating with the Pocket PC. The Microcontroller used in this application is an ATmega 128 of the AVR family from company ATMEL. Two hardware interface circuits, STK500 and STK501, support the Microcontroller connected for In-System-Programming (Neswold, 2001). One RS232 port connects these two hardwires to the PC for programming and another one connects them to the Pocket PC. The jumpers are set so that they can use external 7.3728 MHz crystal oscillators as a clock.

#### 4.6.4 Control, regulation and interface electronics

##### Control :

For the controlling purpose the Microcontroller uses on-chip ADC along with a Digital-to-Analog converter (DAC) chip MAX529. All the measured parameters must pass through the RC high pass filter to attenuate sudden high-voltage peaks.

##### Regulation :

Here four regulations are realized. Three of them are temperature regulation and one is for flow regulation. For the GC-oven temperature regulation, a cascaded regulation circuit is used (Hicham Dakir, 2001 ; Rather, 1993). Control of

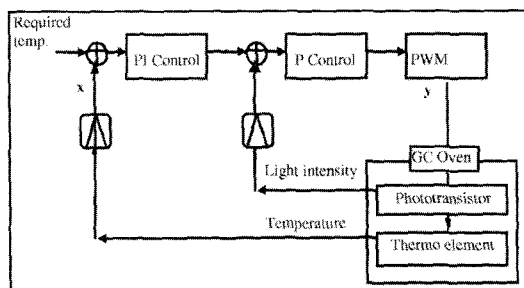

Fig. 8 Cascaded regulation for the GC-Oven

the lamp is realized by pulse width modulation. Fig. 8 shows how it looks like.

The temperature seized with the help of a thermocouple, is fastened with the oven. A thermocouple amplifier AD595 strengthens its thermo voltage.

The temperature of the GC inlet and FID is measured with the help of NiCr-Ni thermocouple. The seized thermo voltage is amplified and then passed through the same amplification stage of the GC Oven with a gain of 2. The GC Inlet temperature regulation is also same like FID regulation. small +12Vdc regulated pump provides the necessary air supply for the FID.

##### Digital Controls :

The FID electrometer connection, FID H2 flow, carrier H2 flow and the relay are controlled digitally by the Microcontroller output.

##### Communication Interface :

The RS232 is used for communication between the target AVR microcontroller and the Pocket PC. The communication is Asynchronous and has 115200 BAUD (Bits/sec.) transmission speed, serial frames with 8-bit data. All these set-ups are software configurable.

##### Pocket PC :

Pocket PC works as user interface with Windows CE operating system. iPAQ H3630 from Compaq is used as the pocket PC.

#### 4.7 Software

The software system consists of programs for the Microcontroller to control and regulation and an application program for the Pocket PC to provide a user interface.

#### 4.7.1 Microcontroller

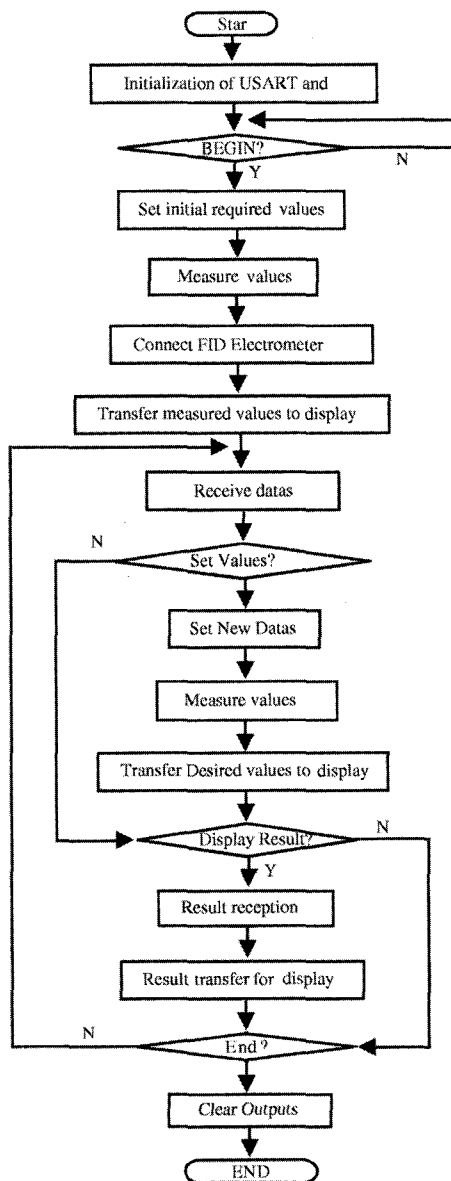

**Fig. 9** Program flow diagram for the Microcontroller

#### 4.7.2 Pocket PC

Pocket PC works as the user interface. It displays the measured temperature and flow rate. Also it allows user to provide required values of the parameters to set. To develop application for Pocket PC, Microsoft Embedded Visual Tool is used. Embedded Visual Tool contains Embedded Visual Basic and Embedded Visual C++. It also

contains a Software Development Kit (SDK) for Pocket PC which contains the desktop emulator. To transfer the developed program to the Pocket PC the device needs to be synchronized with the desktop computer. The software used for this purpose is Microsoft Active Synchronous 3.6.

The Program consists of seven different modules.

<b>Main module :</b> - Initialization - Main window - Message processor
<b>Dialog module :</b> - Input data window - Display analysis result window
<b>Communication module :</b> - Configure serial port and timeout - Start port read thread - Write in the port
<b>Data processing module :</b> - Prepare the data to send and receive - Prepare analysis result to display - Define plot functions to plot result
<b>Screen module :</b> - Prepares the screen to display result - Scroll function definition
<b>Utility module :</b> - Help function definition for the dataproc and communication module

## 5. Test result and evaluation

This GC-FID system is suitable for fast hydrocarbon analysis. Both volatile and semi-volatile hydrocarbons can be detected using this system. To detect semi-volatile Hydrocarbons such as Hexane, Xylene etc. the system needs to have the following gas flow and temperatures.

Carrier=Hydrogen flow rate=12 ml/min,  
 Oven Temp.=0°C to 250°C increase linearly  
 FID H<sub>2</sub> flow rate=15 ml/min  
 Air flow rate= 150ml/min

Injection is done manually.

First some known samples are injected and the output are recorded. Then the mixture of unknown components are injected and the out put

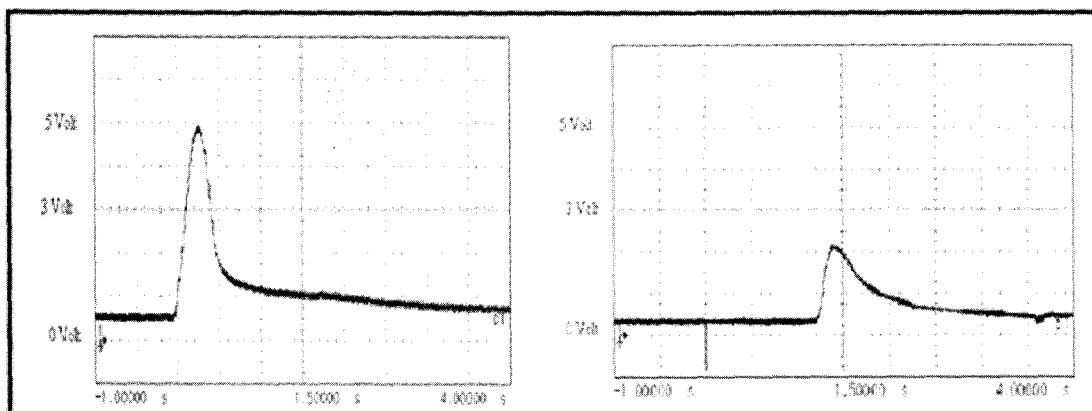

**Fig. 10** Analysis result for 1  $\mu\text{L}$  gaseous Acetone and 1  $\mu\text{L}$  gaseous Pentane respectively

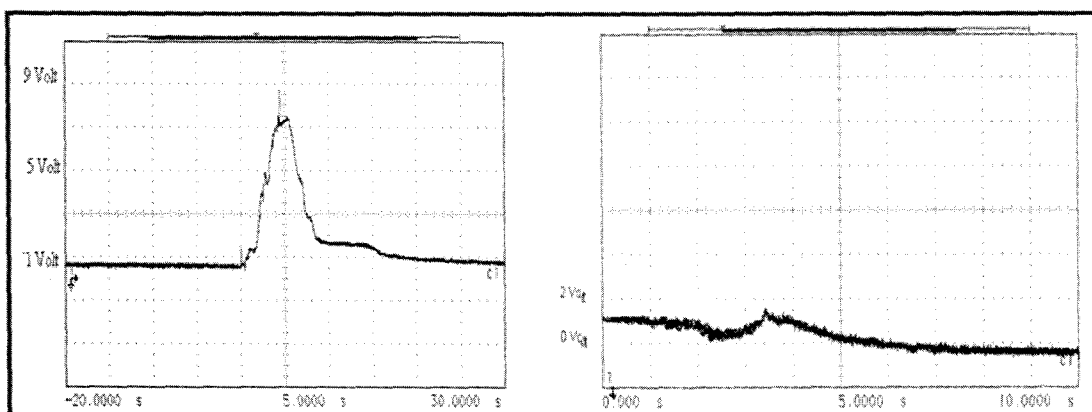

**Fig. 11** Analysis result for 1  $\mu\text{L}$  liquid Methanol and 1  $\mu\text{L}$  liquid xylene respectively

are recorded. From the analysis result found for the known single components the output of the unknown mixture is compared and the components are detected qualitatively.

### 5.1 Single component analysis

Figures 10–12 show the analysis result taken from an oscilloscope for three different single components: Acetone, Pentane and Methanol.

Figure 13 shows analysis result for Methanol and xylene.

Figure 12 shows analysis result for 1  $\mu\text{L}$  Hexane.

### 5.2 Multicomponent analysis

Figures 13 and 14 shows analysis results for multicomponent analysis:

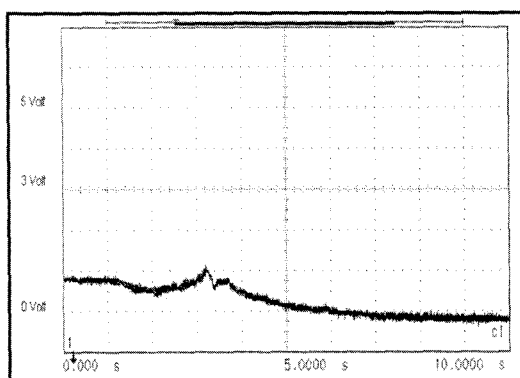

**Fig. 12** Analysis result for 1  $\mu\text{L}$  gaseous Hexane

Sample injected: 2  $\mu\text{L}$  gaseous mixture.

Comparing and analyzing the peaks we can reach the following conclusion:

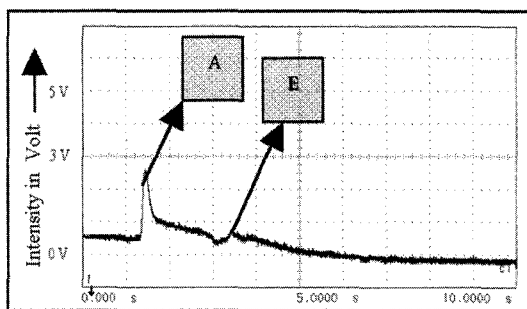

Fig. 13 Analysis result waveform for mixture 1

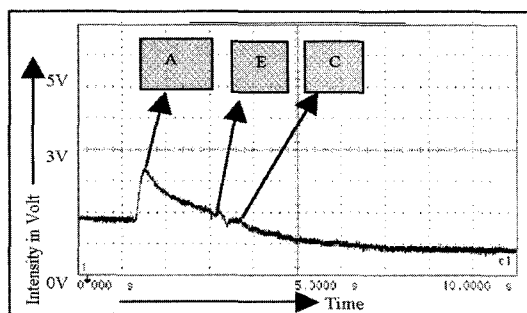

Fig. 14 Analysis result waveform for mixture 2

- Since there are two definite peaks, the mixture contains two components.
- Comparing with Figs. 10 and 11, it is evident that peak A is Pentane and peak B is Xylene.

Samples injected : 3  $\mu$ L gaseous mixture

From Fig. 14 the peaks of different components are visible. Comparison reveals that Peak A is of Pentane, peak B is of Hexane and Peak C is of Xylene. The plot also reveals the noise associated with the result.

## 6. Conclusions

In this paper a prototype was developed which realizes the fast detection of organic molecules especially volatile and semi-volatile hydrocarbons. The system developed is mobile and suitable for field screening. The Gaschromatograph combined with the Flame Ionization Detector is of miniaturized structure and has very good response time. The Microcontroller makes the system parameters control easy and can regulate them accordingly using the control and regulation electronics. The

Pocket PC used in this experiment makes the system really movable and user can see the analysis result anytime anywhere in a very short time.

System can be miniaturized by replacing Hydrogen cylinder by a hydrogen generating cell or a hydrogen generator, using proportional valves to regulate the gas flows automatically from the microcontroller, automizing the injection system, automizing the ignition. To detect the non-volatile hydrocarbons the temperature of the gaschromatograph injector can be increased more.

## References

Ernst Kenndler, 1999, "Introduction to Chromatography," University of Vienna.

Hicham Dakir, 2001, "Aufbau und Steuerung Eines Hochgeschwindigkeits-Gaschromatographen Mit Integriertem Anreicherungsmodul Fur Ein Mobiles Massenspektrometer," Studienarbeit, Technical University of Hamburg-Harburg, Dept. of Measurement Engineering.

Kyunghyun Ryu and Youngtaig Oh, 2003, "A Study on the Usability of Biodiesel Fuel Derived from Rice Bran Oil as an Alternative Fuel for IDI Diesel Engine," *KSME International Journal*, Vol 17, No. 2, pp. 310~317.

Lars Bilke, 2002, "Mikrokontrollergesteuerter Thermodesorber fur die Analyse schwerfluchtiger Abgaskomponenten," Diplomarbeit, Technical University of Hamburg-Harburg, Dept. of Measurement Engineering.

Rahul Banik, 2003, "Construction and Control of a High Speed Miniature Screening Gaschromatography with a Flame Ionization Detector," Diplomarbeit, Technical University of Hamburg-Harburg, Dept. of Measurement Engineering.

Rather, O., 1993. "Analoge Temperaturregelung eines GC mit Halogenlampenheizung," Studienarbeit, Technical University of Hamburg-Harburg, Dept. of Measurement Engineering.

Retention Indices. <URL:www.plant-hormones.info/retentionindex.htm>

Rich Neswold, 2001, "GNU Development Environment for the AVR Microcontroller," <URL: www.avrfreaks.net>.