

# Performance Improvement of Pneumatic Artificial Muscle Manipulators Using Magneto-Rheological Brake

**Kyoung Kwan Ahn\***

*School of Mechanical and Automotive Engineering, University of Ulsan,  
San 29, Muger 2dong, Nam-gu, Ulsan 680-764, Korea*

**TU Diep Cong Thanh**

*Graduate School of Mechanical and Automotive Engineering, University of Ulsan,  
San 29, Muger 2dong, Nam-gu, Ulsan 680-764, Korea*

**Young Kong Ahn**

*Research Center for Machine Parts and Material Processing, University of Ulsan,  
San 29, Muger 2dong, Nam-gu, Ulsan 680-764, Korea*

A novel pneumatic artificial muscle actuator (PAM actuator), which has achieved increased popularity to provide the advantages such as high strength and high power/weight ratio, low cost, compactness, ease of maintenance, cleanliness, readily available and cheap power source, inherent safety and mobility assistance to humans performing tasks, has been regarded during the recent decades as an interesting alternative to hydraulic and electric actuators. However, some limitations still exist, such as the air compressibility and the lack of damping ability of the actuator bring the dynamic delay of the pressure response and cause the oscillatory motion. Then it is not easy to realize the performance of transient response of pneumatic artificial muscle manipulator (PAM manipulator) due to the changes in the external inertia load with high speed. In order to realize satisfactory control performance, a variable damper — Magneto-Rheological Brake (MRB), is equipped to the joint of the manipulator. Superb mixture of conventional PID controller and a phase plane switching control method brings us a novel controller. This proposed controller is appropriate for a kind of plants with nonlinearity, uncertainties and disturbances. The experiments were carried out in practical PAM manipulator and the effectiveness of the proposed control algorithm was demonstrated through experiments, which had proved that the stability of the manipulator can be improved greatly in a high gain control by using MRB with phase plane switching control method and without regard for the changes of external inertia loads.

**Key Words:** Pneumatic artificial muscle, Magneto-Rheological brake, Phase plane switching control, Manipulator

## 1. Introduction

Industrial robots have used three primary po-

---

\* Corresponding Author,

E-mail : kkanh@ulsan.ac.kr

TEL : +82-52-222-1404; FAX : +82-52-259-1680

School of Mechanical and Automotive Engineering,  
University of Ulsan, San 29, Muger 2dong, Nam-gu,  
Ulsan 680-764, Korea. (Manuscript Received July 22,  
2004; Revised January 24, 2005)

wer sources : electric motors, hydraulic cylinders and pneumatic cylinders. Each of these actuation systems has advantages and disadvantages (Table 1). For most robotic applications, the common actuator technology is electric system with very limited use of hydraulics or pneumatics. But electrical systems suffer from relatively low power/weight ratio and especially in the case of human friendly robot, or human coexisting and collaborative systems such as a medical and welfare

**Table 1** Comparison of actuators

Actuator	Advantages	Disadvantages
Pneumatics	Cheap, quick response time, simple control	Position control difficult, fluid compressible, noisy
Hydraulics	High power/weight ratio, low backlash, very strong, direct drive possible	Less reliable, expensive, servo control complex, noisy
Electrics	Accurate position and velocity control, quiet, relative cheap	Low power and torque/weight ratios, possible sparking

fields.

A novel pneumatic artificial muscle actuator (PAM actuator), which has achieved increased popularity to provide these advantages such as high strength and high power/weight ratio, low cost, compactness, ease of maintenance, cleanliness, readily available and cheap power source, inherent safety and mobility assistance to humans performing tasks, has been regarded during the recent decades as an interesting alternative to hydraulic and electric actuators. These advantages have led to the development of novel actuators such as the McKibben Muscle, Rubber Actuator and Pneumatic Artificial Muscle Manipulators (PAM manipulators). The PAM manipulator has been applied to construct a human-friendly therapy robot. For example, 2-dof robot for functional recovery therapy driven by pneumatic muscle was developed by Zobel and his team (1999), and Raparelli and his team (2001, 2003), artificial muscle actuators for biorobotic systems by Klute and his team (1999, 2000, 2002), and a pneumatic muscle hand therapy device by Koeneman and his team (2004). However, the air compressibility and the lack of damping ability of the pneumatic muscle actuator bring the dynamic delay of the pressure response and cause the oscillatory motion. Therefore, it is not easy to realize the performance of transient response with high speed and with respect to various external inertia loads in order to realize a human-friendly therapy robot.

The limitations of the PAM manipulators have promoted research into a number of control strategies, such as a Kohonen-type neural network for the position control of robot end-effector within 1 cm after learning (Hesselroth et al.,

1994). Recently, the authors have developed a feed forward neural network controller, where joint angle and pressure of each chamber of pneumatic muscle are used as learning data and accurate trajectory following was obtained, with an error of  $1[^\circ]$  (Patrick et al., 1996). After applying a feed forward + PID-type controller approach (Caldwell et al., 1993), the authors are turning to an adaptive controller (Caldwell et al., 1994; Caldwell et al., 1995; Medrano-Cerda et al., 1995) which is based on the on-line identification of a model with five parameters and three time delays. Recently, the authors have announced that the position regulation of the joints of their arm prototype is better than  $\pm 0.5[^\circ]$  (Bowler et al., 1996). In addition, PID control (Tsagarakis et al., 1999), sliding mode control (Tondu and Lopex, 2000; Carbonel et al., 2001), fuzzy PD+I learning control (Chan and Lilly, 2003), fuzzy + PID control (Balasubramanian and Rattan, 2003), robust control (Cai and Yamura, 1996; Guihard and Gorce, 1999; Carbonel et al., 2001), feedback linearization control (Kimura et al., 1995), feed forward control + fuzzy logic (Balasubramanian and Rattan, 2003), variable structure control algorithm (Hamerlain, 1995),  $H_\infty$  control (Osuka et al., 1990; Ahn et al., 2003) and so on, have been applied to control the PAM manipulator. Though these systems were successful in addressing smooth actuator motion in response to step inputs, the manipulator must be controlled slowly in order to get stable, accurate position control and the external inertia load was also assumed to be constant or slowly varying. Assuming that PAM manipulator is utilized in the therapy robot in the future such as a rehabilitation robot for the recovery function of

limbs, which is the final goal of this research, it is necessary to realize a fast response, even if the external inertia load changes severely. But fast response cannot be obtained in most pneumatic control systems. At the same time, the external inertia loads cannot always be known exactly. Therefore, it is necessary to propose a new control algorithm, which is applicable to a very compressible pneumatic muscle system with various loads.

Many new control algorithms based on a neural network have been proposed up to now. An intelligent control using a neuro-fuzzy network was proposed by Iskarous and Kawamura (1995). A hybrid network that combines fuzzy and neural network was used to model and control complex dynamic systems, such as the PAM system. An adaptive controller based on the neural network was applied to the artificial hand, which is composed of the PAM (Folgheraiter et al., 2003). Here, the neural network was used as a controller, which had the form of a compensator or the inverse of the model. It was not easy to apply these control algorithms to the quickly-changing inertia load systems and to reconcile both damping and response speed in high gain control.

To overcome these problems, a new technology, Electro-Rheological Fluid Damper (ER Damper), has been applied to the PAM manipulator. Noritsugu and his team has used ER damper to improve the control performance of the PAM

manipulator with PI controller and pulse code modulated on-off valves (Noritsugu et al., 1997; 1999). By separating the region where the damper produces an damping torque in order to reconcile both the damping and the response speed in high gain control, the results show that ER damper is one of the most effective methods to develop a practically available human friendly robot by using the PAM manipulator and also the performance of position control is improved without decreasing the response speed. However, some limitations still exist, because ER Fluid (ERF) requires extremely high control voltage (kV), which is problematical and potentially dangerous, and it has a narrow operation range of temperature which can not be applied to the PAM manipulator, and has also the characteristics of non-linearity. Because of the unacceptable disadvantages of ERF, Magneto-Rheological Fluid (MRF) attracts people's attention with these advantages in Table 2, in recent years. MR fluid is similar to ER fluid, but it is 20~50 times stronger in the yield stress. It can also be operated directly from low-voltage power supplies and is far less sensitive to contaminants and temperature. Therefore, magnetic fluid technology can provide flexible control capabilities in designs that are far less complicated and more reliable than conventional electro-mechanical products and it has been applied to a variety of devices. MR fluids can provide active control of energy dissipation for semi-active damper or braking system.

**Table 2** Comparison of Rheological fluids

	Magneto-Rheological Fluid	Electro-Rheological Fluid
Max. Yield Stress	50–100 kPa	2–5 kPa
Viscosity	0.1–1.0 Pa·s	0.1–1.0 Pa·s
Operable Temp. Range	–40 to +150°C	+10 to +90°C (ionic, DC) –25 to +125°C (non-ionic, AC)
Stability	Unaffected by most impurities	Cannot tolerate impurities
Response Time	<milliseconds	<milliseconds
Density	3–4 g/cm <sup>3</sup>	1–2 g/cm <sup>3</sup>
Max. Energy Density	0.1 Joule/cm <sup>3</sup>	0.001 Joule/cm <sup>3</sup>
Power Supply	2–25 V @ 1–2 A (2–50 watts)	2–25 KV @ 1–10 mA (2–50 watts)

Thus, the goal of this paper is to implement a magneto-rheological brake, to develop a fast, accurate pneumatic control system and without regard to the changes of external inertia loads. Superb mixture of conventional PID controller and a phase plane switching control method bring us a novel controller. This proposed controller is appropriate for a kind of plants with nonlinearity uncertainties and disturbances. The experiments were carried out in practical PAM manipulator and the effectiveness of the proposed control algorithm was demonstrated through experiments, which had proved that the stability of the manipulator can be well improved in a high gain control by using MRB with phase plane switching control method and without decreasing the response speed and low stiffness of manipulator.

## 2. Experimental Setup

### 2.1 Experimental apparatus

The schematic diagram of the pneumatic artificial muscle manipulator is shown in Fig. 1. The hardware includes an IBM compatible personal computer (Pentium 1 GHz), which calculates the control input, controls the proportional valve (FESTO, MPYE-5-1/8HF-710 B) and Magneto-Rheological Rotary Brake (LORD, MRB-2107-3 Rotary Brake), through D/A board (Advantech, PCI 1720), and two pneumatic artificial muscles (FESTO, MAS-10-N-220-AA-MCFK). The braking torque of magneto-rheological rotary brake is controlled by D/A board

through voltage to current converter, Wonder Box Device Controller Kit (LORD, RD-3002-03). And the lists of experimental hardware are tabulated in Table 3. The structure of the artificial

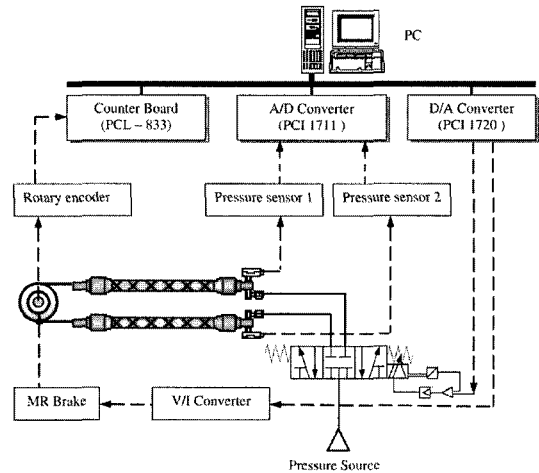

Fig. 1 Schematic diagram of pneumatic artificial muscle manipulator

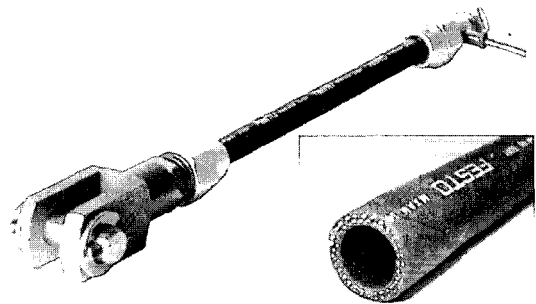

Fig. 2 Structure of the pneumatic artificial muscle

Table 3 Experimental hardware

No.	Name	Model name	Company
1	Proportional Valve	MPYE-5-1/8HF-710 B	Festo
2	Magneto-Rheological Rotary Brake	MRB-2107-3 Rotary Brake	Lord
3	Pneumatic artificial muscle	MAS-10-N-220-AA-MCFK	Festo
4	D/A board	PCI 1720	Advantech
5	A/D board	PCI 1711	Advantech
6	Wonder Box Device Controller Kit	RD-3002-03	Lord
7	Rotary encoder	H40-8-3600ZO	Metronix
8	Pressure sensor	SDE-10-10	Festo
9	24-bit digital counter board	PCL 833	Advantech

muscle is shown in Fig. 2. The rotating torque is generated by the pressure difference between the antagonistic artificial muscles and the external load is rotated as a result (Fig. 4). A joint angle,

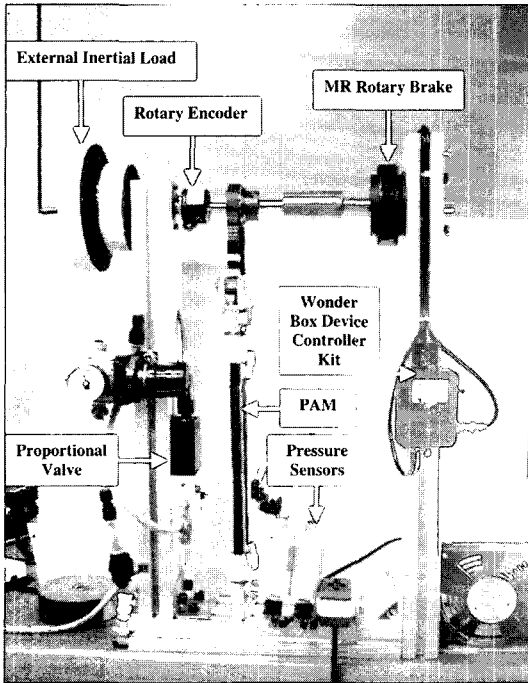

Fig. 3 Photograph of the experimental apparatus

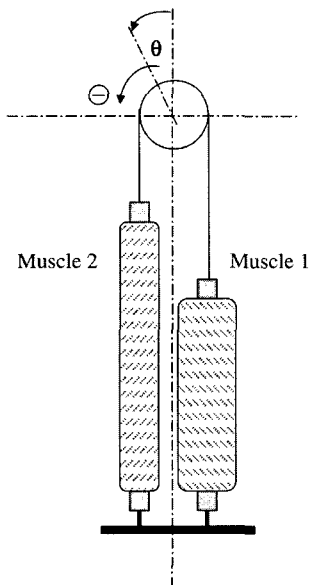

Fig. 4 Working principle of pneumatic artificial muscle manipulator

$\theta$ , is detected by rotary encoder (METRONIX, H40-8-3600ZO) and the air pressure into each chamber is also measured by the pressure sensors (FESTO, SDE-10-10) and fed back to the computer through 24-bit digital counter board (Advantech, PCL 833) and A/D board (Advantech, PCI 1711), respectively. The external inertia load could be changed from 20 [kg·cm<sup>2</sup>] to 200 [kg·cm<sup>2</sup>], which is a 1,000 [%] change with respect to the minimum inertia load condition. The experiments are conducted under the pressure of 0.4 [MPa] and all control software is coded in C program language. A photograph of the experimental apparatus is shown in Fig. 3.

## 2.2 Characteristics of the PAM manipulator

The PAM is a tube clothed with a sleeve made of twisted fiber-code, and fixed at both ends by fixtures. The muscle is expanded to the radial direction and constricted to the vertical direction by raising an inner pressure of the muscle through a power-conversion mechanism of the fiber-codes. The PAM has a property like a spring, and can change its own compliance by the inner pressure. A few slide parts and a little friction are favorable to a delicate power control. But the PAM has characteristics of hysteresis, non-linearity and low damping. Particularly, the system dynamics of the PAM changes drastically by the compressibility of air in cases of changing external loads. In our experiments, the external load changed about 1,000 [%] with respect to the minimum inertia condition.

When using the PAM for the control of manipulator, it is necessary to understand its characteristics such as the hysteresis, nonlinearity and so on. Therefore the following experiments are performed to investigate the characteristics of the PAM. Figures 5 and 6 demonstrate the hysteresis characteristics for the joint. This hysteresis can be shown by rotating a joint along a pressure trajectory from  $P_1=P_{\max}$ ,  $P_2=0$  to  $P_1=0$ ,  $P_2=P_{\max}$  and back again by incrementing and decrementing the pressures by controlling the proportional valve. The hysteresis of the PAM is shown in Fig. 6. The width of the gap between the two

curves depends on how fast the pressures are changed ; the slower the change in the pressures, the narrower the gap. The trajectory, control input to the proportional valve, velocity, and

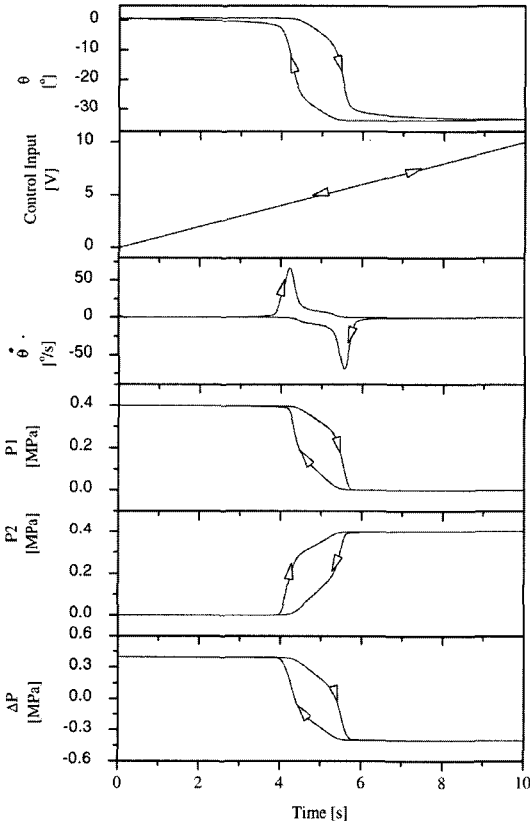

Fig. 5 Characteristics of pneumatic artificial muscle manipulator

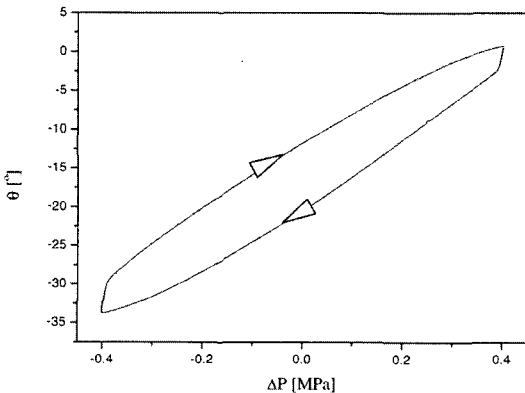

Fig. 6 Hysteresis of pneumatic artificial muscle manipulator

pressure of each chamber of the PAM are depicted in Fig. 5. The velocity is numerically computed from the position. Near the extreme values, the joint velocity decreases since the increase in exerted force for a constant change in pressure is less.

### 2.3 Characteristics of MRB

Construction of MR rotary brake was shown in Fig. 7. The rotor in Fig. 7 is fixed to the shaft, which can rotate in relation to housing. Between rotor and housing there is a gap filled with MR fluid. Braking torque of magneto-rheological rotary brake can be controlled by the electric current in its coil. An apparent viscosity of MR fluid is changed at few milliseconds after the application of a magnetic field, and goes back to the normal viscosity with no magnetic field.

The following experiments are performed to investigate the characteristics of MRB, which measurement data is shown in Fig. 8 and Table 4. MRB is connected with a torque transducer and a servomotor in series. In this experiments, the rotational speed is changed from 100 [rpm] to 1000 [rpm] and the current applied for MRB is changed from 0 [A] to 1 [A]. The reason for choosing this range of rotational speed and cur-

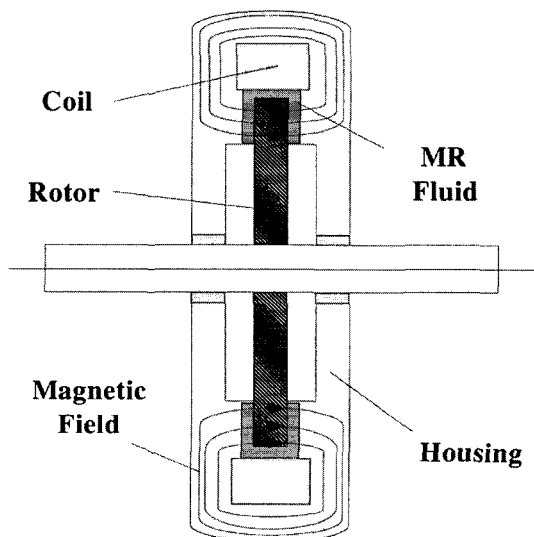

Fig. 7 Construction of magneto-rheological rotary brake

rent is that the response of system does not reach to 1000 [rpm] and the maximum current applied for MRB is 1 [A]. Figure 8 shows the damping torque with respect to the change of the input current (a) and rotational speed (b) of MR

Brake. From Fig. 8, it is clear that the damping torque of MRB is independent of rotational speed and almost proportional to input current. Thus an equation (1) holds between the inputs current  $I$  and damping torque  $T_b$

$$T_b = f(I) = a + bI \tag{1}$$

Here,  $a$  and  $b$  are constant.

### 3. Phase Plane Switching Control Algorithm

#### 3.1 The overall control system

The strategy of PID control has been one of the sophisticated methods and the most frequently used control algorithms in the industry. This is because that the PID controller has a simple form and strong robustness in broad operating area. To control this PAM manipulator, a conventional PID control algorithm was applied in this paper as the basic controller. The controller output can be expressed in the time domain as :

$$u(t) = K_p e(t) + \frac{K_p}{T_i} \int_0^t e(t) dt + K_p T_d \frac{de(t)}{dt} \tag{2}$$

Taking the Laplace transform of (2) yields :

$$U(s) = K_p E(s) + \frac{K_p}{T_i s} E(s) + K_p T_d s E(s) \tag{3}$$

and the resulting PID controller transfer function of :

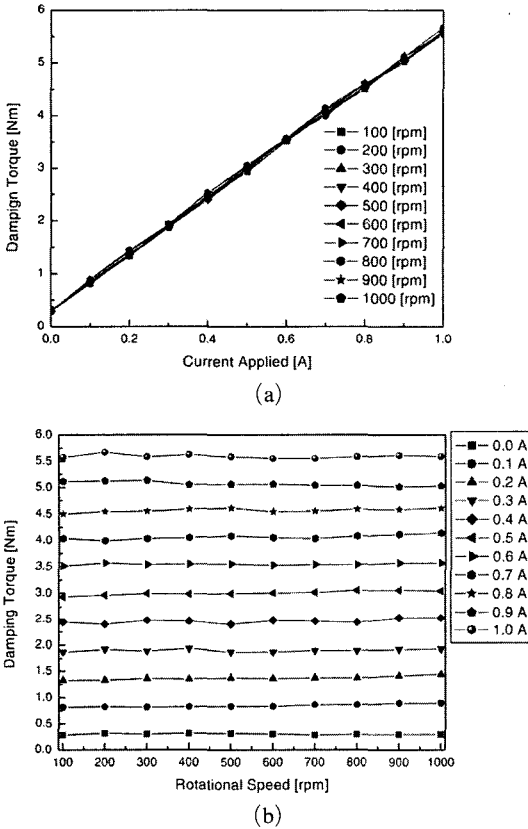

Fig. 8 Characteristics of MRB

Table 4 Measurement Data of MRB

Rotational Speed/ Current Applied	0	0.1	0.2	0.3	0.4	0.5	0.6	0.7	0.8	0.9	1
100	0.28	0.81	1.33	1.87	2.44	2.93	3.51	4.03	4.5	5.11	5.57
200	0.31	0.82	1.33	1.92	2.4	2.96	3.57	3.99	4.54	5.12	5.67
300	0.3	0.81	1.36	1.89	2.48	2.99	3.54	4.03	4.55	5.13	5.58
400	0.31	0.82	1.35	1.94	2.46	2.98	3.55	4.05	4.59	5.05	5.62
500	0.31	0.83	1.37	1.87	2.4	2.99	3.55	4.08	4.61	5.06	5.58
600	0.3	0.83	1.36	1.87	2.48	3	3.53	4.05	4.54	5.06	5.55
700	0.28	0.86	1.37	1.9	2.46	3.01	3.54	4.03	4.55	5.04	5.55
800	0.29	0.86	1.37	1.9	2.44	3.05	3.45	4.08	4.59	5.04	5.68
900	0.29	0.89	1.41	1.92	2.53	3.05	3.57	4.11	4.58	5.01	5.61
1000	0.29	0.89	1.44	1.93	2.53	3.04	3.57	4.14	4.61	5.03	5.59

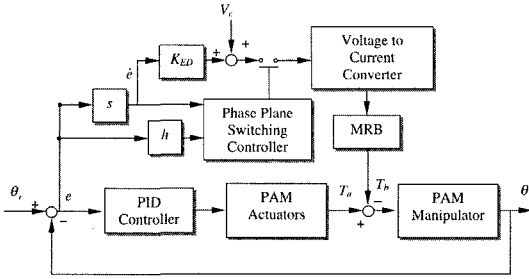

Fig. 9 Block diagram of control system

$$\frac{U(s)}{E(s)} = K_p \left( 1 + \frac{1}{T_i s} + T_d s \right) \quad (4)$$

A typical real-time implementation at sampling sequence  $k$  can be expressed as :

$$u(k) = K_p e(k) + u(k-1) + \frac{K_p T}{T_i} e(k) + K_p T_d \frac{e(k) - e(k-1)}{T} \quad (5)$$

where  $K_p$ ,  $T_i$ ,  $T_d$ ,  $u(k)$  and  $e(k)$  are the proportional gain, integral time, derivative time, control input to the control valve and the error between the desired set point and the output of joint, respectively.

In addition, MRB is one of effective methods to improve the control performance of the PAM manipulator by reconciling both the damping and response speed because it works in only the regions where the acceleration or deceleration is too high. The structure of the proposed phase plane switching control method is shown in Fig. 9.

Here,  $s$  is Laplace operator,  $T_a$  is torque produced by manipulator,  $T_c$  is constant torque and  $K_{ED}$  determines a gain for the torque proportional to the angular speed  $\dot{\theta}$ ,  $V_c$  is a control voltage of source calculated from Eq. (1) to produce  $T_c$ . A direction of a damping torque is every time opposite to the rotary direction of the arm. So Eq. (6) below indicates that the damper produces a torque  $T_b$ .

$$T_b = (K_{ED} \dot{\theta} + T_c) \text{sign}(\dot{\theta}) \quad (6)$$

### 3.2 Phase plane switching control method

The damping torque  $T_b$  improves the damping performance of the manipulator. Since the dam-

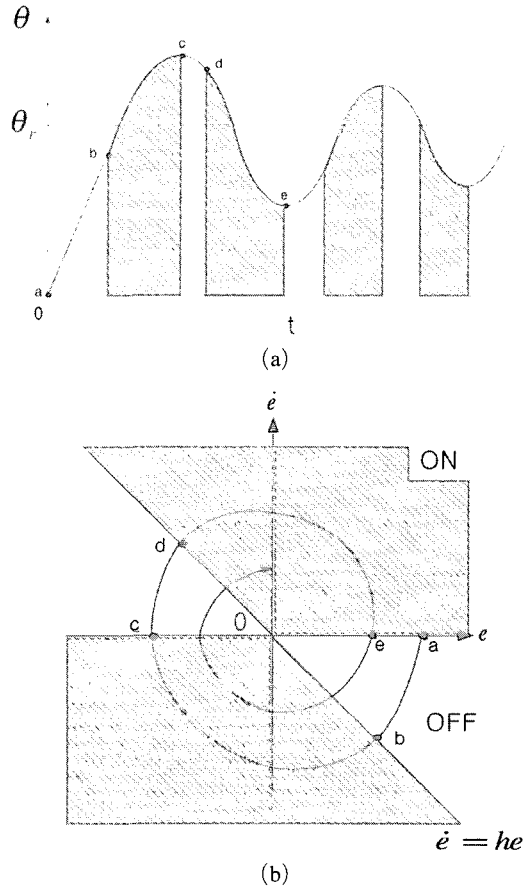

Fig. 10 Concept of phase plane switching control

ping torque every time acts in the direction against the rotational direction of manipulator, its acceleration performance is degraded. In the region that the joint angle of the arm approaches to the desired angle,  $a \sim b$ ,  $c \sim d$  in Fig. 10(a), the current is not applied not to interfere the movement of the arm, since the high response speed is required. In the region the arm passes the desired angle, i.e. the diagonally shaded areas of  $b \sim c$ ,  $d \sim e$  in Fig. 10(a), a current is applied to improve the damping performance to converge to the desired angle quickly. To determine whether the magnetic field should be applied or not, the phase plane shown in Fig. 10(b) is used. The horizontal axis in the phase plane corresponds to joint angle deviation  $e$  between the desired angle  $\theta_r$  and the joint angle  $\theta$ , and the vertical axis corresponds to the derivation of the deviation



$\dot{e} = \frac{de}{dt} = -\dot{\theta}$ . Each point  $a \sim e$  on the phase plane corresponds to each point  $a \sim e$  in Fig. 10 (a). Here, the region with the application of current is controlled by  $h$  [s<sup>-1</sup>], the gradient of the line shown in Fig. 10(b). The region under the application of the damping torque expands as  $|h|$  decrease.

The effectiveness of the proposed controller will be demonstrated through experiments with various external inertia loads.

### 4. Experimental Results

Experiments were carried out with 3 cases of external inertia loads (20, 60, 200 [kg·cm<sup>2</sup>]) and the comparison between the conventional PID controller and the phase plane switching controller was presented.

Figure 11 shows the experimental results of the conventional PID controller where the minimum external inertia load (20 [kg·cm<sup>2</sup>]) was used with the following 2 control parameters  $K_p = 200 \times 10^{-6}$ ,  $K_i = 1 \times 10^{-6}$ ,  $K_d = 70 \times 10^{-6}$  (PID controller 1) and  $K_p = 1000 \times 10^{-6}$ ,  $K_i = 10 \times 10^{-6}$ ,  $K_d = 130 \times 10^{-6}$ , (PID controller 2). It is obvious that it is difficult to satisfy both the damping and response speed. The manipulator must be controlled slowly in order to have a good stability. On the contrast, the overshoot and oscillation are always included if one wants fast response. In addition, experimental results with respect to 3 cases of external inertia loads (Load 1:20 [kg·cm<sup>2</sup>]; Load 2:60 [kg·cm<sup>2</sup>]; Load 3:200 [kg·cm<sup>2</sup>]) and PID controller 2 were shown in Fig. 12. From these results, it was understood that the system response became more oscillatory according to the increase of the external inertia load and became unstable with ten times bigger external inertia load.

Next, the experiments were carried out in practical PAM manipulator and the control parameters of the proposed controller, which was mentioned in Eq. (6), were set to be  $T_c = 0.4$ ,  $h = -20$  with various  $K_{ED}$  ( $K_{ED} = 0.010$ ,  $K_{ED} = 0.015$ ,  $K_{ED} = 0.020$ ) in experiment condition 1 and  $K_{ED} = 0.015$ ,  $T_c = 0.4$  with various  $h$  ( $h =$

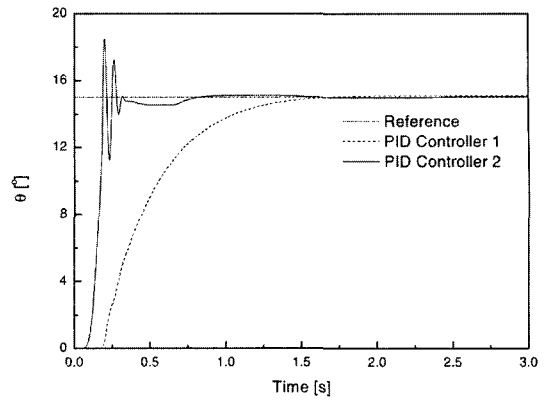

Fig. 11 Comparison between PID controller 1 and PID controller 2

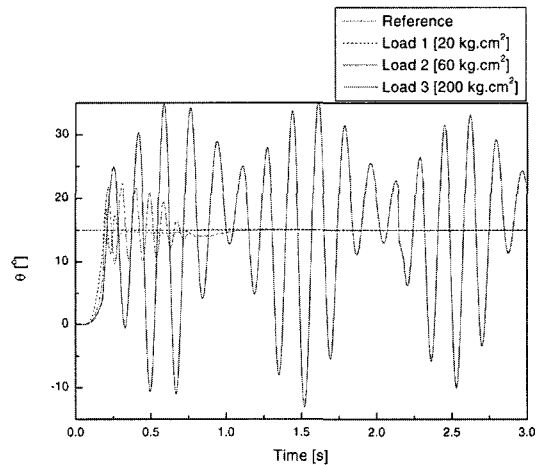

Fig. 12 Experimental results of PID controller 2 with various loads

$-10$ ,  $h = -20$ ,  $h = -50$ ) in experiment condition 2. These control parameters were obtained by trial-and-error through experiments. The experimental results with respect to the experimental condition 1 and 2 were shown in Fig.13 and 14, respectively. In Fig. 13 and 14, the control parameters of phase plane switching controller were set to be  $K_{ED} = 0.015$ ,  $T_c = 0.4$  and  $h = -20$ . All experiments were carried out by this condition of phase plane from now on.

In Fig. 15, comparisons were made between the conventional PID controller 2 and the proposed controller with respect to load condition 1. In the experiments, the joint angle of PAM manipulator

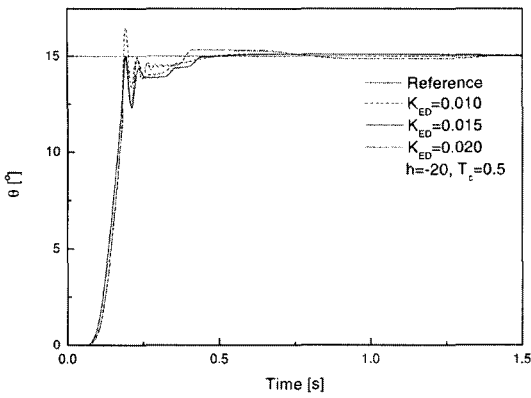

Fig. 13 Experimental results of proposed controller with various parameter of  $K_{ED}$

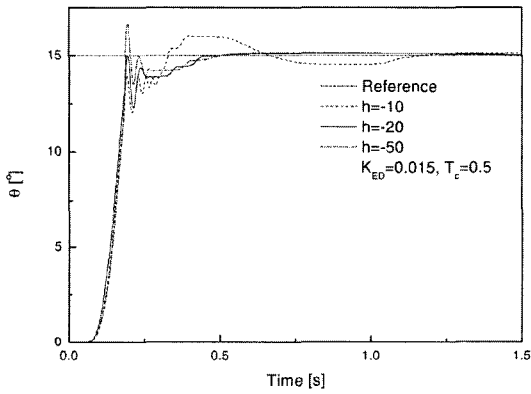

Fig. 14 Experimental results of proposed controller with various parameter of  $h$

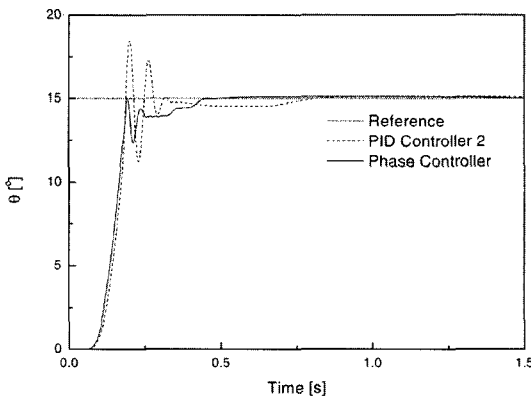

Fig. 15 Comparison between PID controller 2 and phase plane switching control method (Load 1)

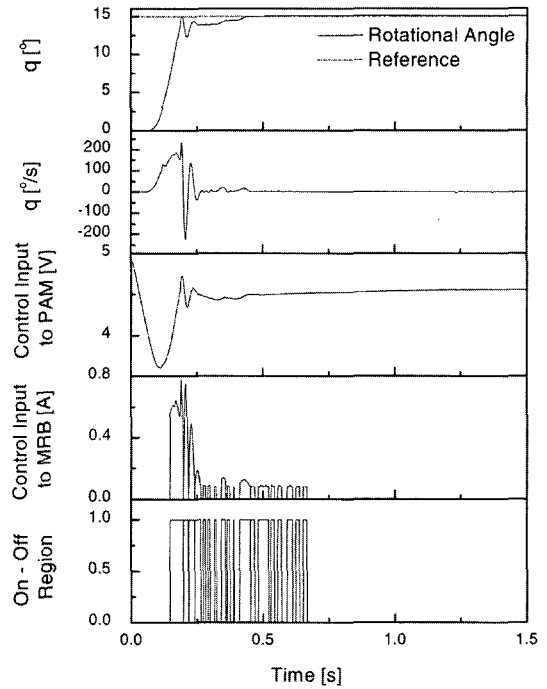

Fig. 16 Experimental results of phase plane switching control method (Load 1)

it was demonstrated that the proposed algorithm was effective in this experimental condition. The region of damping and control input into MRB were shown in Fig. 16. The damping torque was not applied for fast response when the manipulator starts to move and the damping torque was generated by MRB to the rotational axis of PAM manipulator in order to reduce the overshoot and oscillation when the manipulator reaches the desired angle.

Next, experiments were executed to investigate the control performance with respect to various external inertia loads. Figure 17 shows the comparison between the conventional PID controller 2 and the proposed controller with respect to the load condition 2. From the experimental results, it was found that a good control performance and strong robustness were obtained without respect to the variation of external inertia load by using phase plane switching control method. In Fig. 18, the detail of the experiment of phase plane switching control method with external inertia load condition 2 was shown. From this experi-

was in good agreement with that of reference and

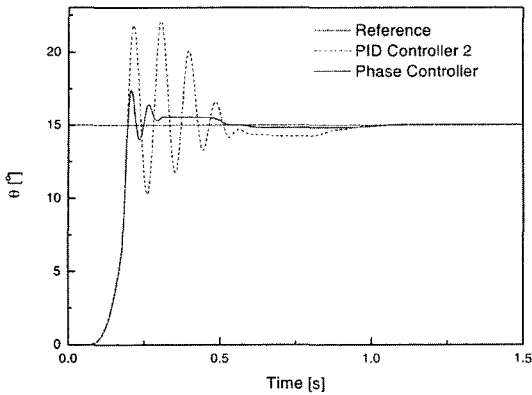

Fig. 17 Comparison between PID controller 2 and phase plane switching control method (Load 2)

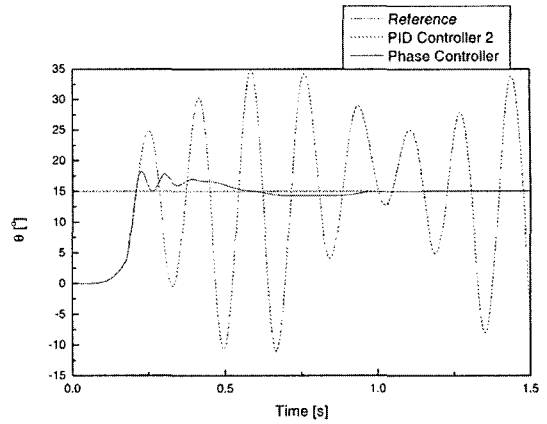

Fig. 19 Comparison between PID controller 2 and phase plane switching control method (Load 3)

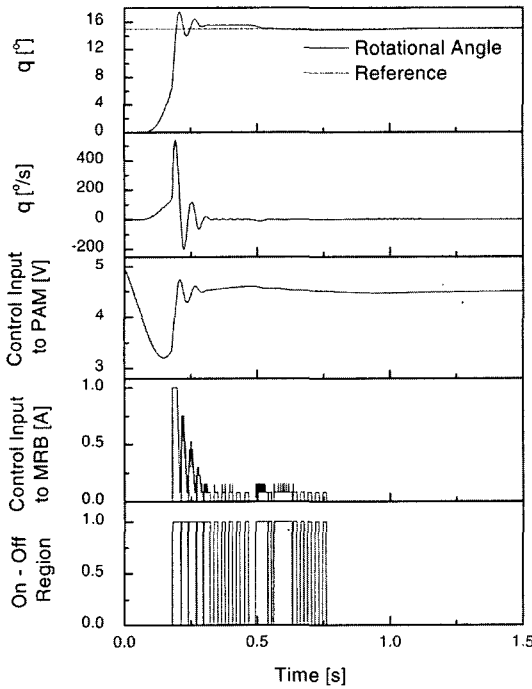

Fig. 18 Experimental results of phase plane switching control method (Load 2)

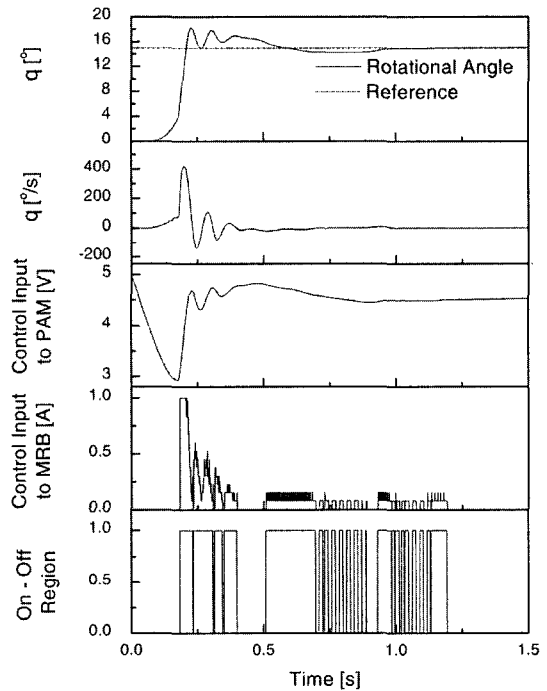

Fig. 20 Experimental results of phase plane switching control method (Load 3)

mental result, the damping torque was applied and released very frequently according to the approach to the desired angle.

In Fig. 19, experiments were conducted to compare the system response of PID controller 2 and proposed phase plane switching controller under the external load condition 3. With up to

ten times bigger external inertia load with respect to the minimum external inertia load, a good control performance was also obtained. Here, the steady state error was within  $\pm 0.05$  [°]. Figure 20 shows the experimental results of phase plane switching control method in detail with respect

to the external inertia load condition 3. It was concluded that the proposed controller was very effective in the high gain control, fast response and robust stability with ten times changes of external inertia load.

However, there still remain some problems such as the difficulty of the selection of the optimal control parameters of proposed phase plane switching controller in order to get a good control performance of the PAM manipulator, especially with various external inertia loads.

There is no previous research to find optimal control parameters in case of phase plane switching control method up to now. As future study, we are planning to design a new intelligent control algorithm using neural network with phase plane switching control method, which utilizes the adaptive and learning capabilities of neural network in order to find the optimal control parameters with respect to various external inertia loads.

## 5. Conclusions

In this paper, a new phase plane switching control method using the magneto-rheological brake was applied to the pneumatic artificial muscle manipulators in order to improve the control performance with various external inertia loads.

From the experimental results, the newly proposed controller was very effectively in high gain control with respect to the 1,000 [%] external inertia load variation. And the steady state error with respect to various loads was reduced within  $\pm 0.05$  [°]. It was verified that the proposed control algorithm presented in this study had simple structure and had better dynamic property, strong robustness and it was suitable for the control of various plants, including linear and nonlinear process, compared to the conventional PID controller.

By using MRB as a variable damper, the damping torque was controlled by the applying magnetic field strength and the position control performance was improved without the decrease of response speed by separating the region where the

damper produces an damping torque by phase plane switching control method.

The results show that the MRB is one of effective methods to develop a practically available human friendly robot by using the PAM manipulator.

## Acknowledgments

This work was supported partly by the Korea Science and Engineering Foundation (KOSEF) through the Research Center for Machine Parts and Materials Processing (ReMM) at University of Ulsan.

## References

- Ahn, K. K., Lee, B. R. and Yang, S. Y., 2003, "Design and Experimental Evaluation of a Robust Force Controller for a 6-Link Electro-Hydraulic Manipulator Via  $H$  Infinity Control Theory," in *KSME, Int., Jour.*, Vol. 17, No. 7, pp. 999~1010.
- Ahn, K. K. and Tu, D. C. T., 2004, "Improvement of the Control Performance of Pneumatic Artificial Manipulators Using an Intelligent Switching Control Method," in *KSME, Int., Jour.*, Vol. 18, No. 8, pp. 1388~1400.
- Balasubramanian, V. and Rattan, K. S., 2003, "Feedforward Control of a Non-Linear Pneumatic Muscle System Using Fuzzy Logic," in *IEEE Int., Conf., Fuzzy Systems*, Vol. 1, pp. 272~ 277.
- Bowler, C. J., Caldwell, D. G. and Medrano-Cerda, G. A., 1996, "Pneumatic Muscle Actuators; Musculature for an Anthropomorphic Robot Arm," in *Proc. IEE Colloquium on Actuator Technology Current Practice and New Developments*, London, pp. 8/1~8/5.
- Cai, D. and Yamaura, H., 1997, "A VSS Control Method for a Manipulator Driven by an McKibben Artificial Muscle Actuator," *Electron, Commun, Japan*, Vol. 80, No. 3, pp. 55~63.
- Caldwell, D. G., Medrano-Cerda, G. A. and Goodwin, M. J., 1995, "Control of Pneumatic Muscle Actuators," *IEEE Contr., Syst., Mag.*, Vol. 15, No. 1, pp. 40~48.
- Caldwell, D. G., Medrano-Cerda, G. A. and

- Goodwin, M. J., 1994, "Characteristics and Adaptive Control of Pneumatic Muscle Actuators for a Robotic Elbow," in *Proc., IEEE Int., Conf. Robotics and Automation*, Vol. 4, pp. 3558~3563.
- Carbonell, P., Jiang, Z. P. and Repperger, D. W., 2001, "Nonlinear Control of a Pneumatic Muscle Actuator: Backstepping vs. Sliding-Mode," in *Proc., IEEE Int., Conf., Control Applications*, Mexico City, Mexico, pp. 167~172.
- Chan, S. W., Lilly, J. H., Repperger, D. W. and Berlin, J. E., 2003, "Fuzzy PD+I Learning Control for a Pneumatic Muscle," in *IEEE Int., Conf., Fuzzy Systems*, Vol. 1, pp. 278~283.
- Folgheraiter, M., Gini, G., Perkowski, M. and Pivtoraiko, M., 2003, "Adaptive Reflex Control for an Artificial Hand," in *Proc., SYROCO 2003, Symposium on Robot Control*, Holliday Inn, Wroclaw, Poland.
- Gaylord, R. H., 1958, United States Patent 2, 844,126.
- Guihard, M. and Gorce, P., 1999, "Dynamic Control of an Artificial Muscle Arm," in *Proc., IEEE Int., Conf., Systems, Man and Cybernetics*, Le Touque, France, Vol. 4, pp. 813~818.
- Hamerlain, M., 1995, "An Anthropomorphic Robot Arm Driven by Artificial Muscles Using a Variable Structure Control," in *IEEE/RSJ Int., Conf., Intelligent Robots and Systems*, Vol. 1, pp. 550~555.
- Hesselroth, T., Sarkar, K., Patrick van der Smagt, P. and Schulten, K., 1994, "Neural Network Control of a Pneumatic Robot Arm," *IEEE Trans Syst., Man., Cybernetics.*, Vol. 24, No. 1, pp. 28~38.
- Iskarous, M. and Kawamura, K., 1995, "Intelligent Control Using a Neuro-Fuzzy Network," in *Proc., IEEE/RSI Int., Conf., Intelligent Robots and Systems*, Vol. 3, pp. 350~355.
- Klute, G. K., Czerniecki, J. M. and Hannaford, B., 2002, "Artificial Muscles: Actuators for Bi-robotic Systems," *Accepted for Publication, Int., Jour., Robotics Research*.
- Klute, G. K., Czerniecki, J. and Hannaford, B., 1999, "McKibben Artificial Muscles: Actuators with Biomechanical Intelligence," *Proc., IEEE/ASME Int., Conf., Advanced Intelligent Mechatronics*, pp. 221~226.
- Klute, G. K., Czerniecki, J. and Hannaford, B., 2000, "Artificial Tendons: Biomechanical Properties for Prosthetic Lower Limbs," *Proc., IEEE Int., Conf., Medical Physics and Biomedical Engineering*, Vol. 3, pp. 1972~1975.
- Klute, G. K., Czerniecki, J. and Hannaford, B., 2000, "Muscle-Like Pneumatic Actuators for Below-Knee Prostheses," *Proc. Int., Conf., New Actuators*, pp. 289~292.
- Koeneman, E. J., Schultz, R. S., Wolf, S. L., Herring, D. E. and Koeneman, J. B., 2004, "A Pneumatic Muscle Hand Therapy Device," *Proc., IEEE/EMBS Int., Conf.*, pp. 2711~2713.
- Medrano-Cerda, G. A., Bowler, C. J. and Caldwell, D. G., 1995, "Adaptive Position Control of Antagonistic Pneumatic Muscle Actuators," in *Proc. IEEE/RSJ Int., Conf., Intelligent Robots and Systems, Human Robot Interaction and Cooperative Robots*, Pittsburgh, PA, pp. 378~383.
- Nickel, V. L., Perry, J. and Garrett, A. L., 1963, "Development of Useful Function in the Severely Paralyzed Hand," in *Jour., Bone and Joint Surgery*, Vol. 45A, No. 5, pp. 933~952.
- Noritsugu, T. and Tanaka, T., 1997, "Application of Rubber Artificial Muscle Manipulator as a Rehabilitation Robot," in *IEEE/ASME Trans., Mechatronics*, Vol. 2, pp. 259~267.
- Noritsugu, T., Tsuji, Y. and Ito, K., 1999, "Improvement of Control Performance of Pneumatic Rubber Artificial Muscle Manipulator by Using Electrorheological Fluid Damper," in *Proc., IEEE Int., Conf., Systems, Man and Cybernetics*, Seattle, Washington, Vol. 4, pp. 788~793.
- Osuka, K., Kimura, T. and Ono, T., 1990, "H<sub>∞</sub> Control of a Certain Nonlinear Actuator," in *Proc., IEEE Int., Conf., Decision and Control*, Honolulu, Hawaii, Vol. 1, pp. 370~371.
- Patrick van der Smagt, P., Groen, F. and Schulten, K., 1996, "Analysis and Control of a Rubbertuator Arm," *Biol. Cybernet.*, Vol. 75, pp. 433~440.
- Raparelli, T., Zobel, P. B. and Durante, F., 2001, "The Design of a 2 DOF Robot for Functional Recovery Therapy Driven by Pneumatic Muscles," *Int., Workshop on robotics in ALPA* —

*DRIA-DANUBE region.*

Raparelli, T., Zobel, P. B. and Durante, F., 2003, "Development of a Robot Driven by Pneumatic Muscles," *Proc., RAAD, Workshop on robotics in ALPA — DRIA-DANUBE region.*

Schulte, H. F., 1961, "The Characteristics of the McKibben Artificial Muscle," *The Application of External Power in Prosthetics and Orthotics, National Academy of Sciences-National Research Council, Appendix H*, pp. 94~115.

Tondu, B. and Lopex, P., 2000, "Modeling and Control of McKibben Artificial Muscle Robot Actuators," *IEEE Contr., Syst., Mag.*, Vol. 20,

No. 1, pp. 15~38.

Tsagarakis, N., Caldwell, D. G. and Medrano-Cerda, G. A., 1999, "A 7 DOF Pneumatic Muscle Actuator (pMA) Powered Exoskeleton," *IEEE International Workshop on Robot and Human Interaction*, Pisa, Italy, pp. 327~333.

Zobel, P. B., Durante, F. and Raparelli, T., 1999, "The Experience of the University of L'Aquila on the Pneumatic Muscle Actuators for a 2 DOF Manipulator for Function Recovery Therapy," *Seminar on Biomechanics*, Warsaw, Poland.