

## A Study on the Control Characteristics of ER Valve-FHA System and Durability Test

**Sung-Cheol Jang**

*Department of Mechanical and Automation Engineering, Kyungnam University,  
449 Wolyoung Dong, Masan, Kyungnam 631-701, Korea*

**Tae-Hyun Chang\***

*Department of Mechanical and Automation Engineering, Kyungnam University,  
449 Wolyoung Dong, Masan, Kyungnam 631-701, Korea*

In this paper, making the best use of the features of the electro-rheological (ER) valve, a two-port pressure control valve using ER fluids is proposed and manufactured. The ER-Valve characteristics are evaluated by changing the intensity of the electric field and the number of electrode. As only with electrical signal change to the ER-Valve in which ER fluid flowing, ER fluid flow is controlled, so development of simple ER-Valves have been tried. The ER-Valves and pressure drop check method are considered to be applied to the fluid power industry. Using the manufactured pressure control valve, a one-link manipulator with FHA (Flexible Hydraulic Actuator) is driven. As a result, it is experimentally confirmed that the pressure control valve using ER fluids is applicable to use in driving actuator. If it applies characteristics of the ER fluids, it will be able to apply in the control system for the ER Valve which occurs from industrial controller. After having durability test, shear stress increased regularly because of starch particles crushed by pump and particle size that was almost the same. Moreover, Ra of copper electrode increased about 1.56 times rather than before those of performing durability test, and Rz increased about 2.2 times.

**Key Words :** Flexible Hydraulic Actuator, ER-Valve, Manipulator, Control System, Industrial Controller, Durability Test

### Nomenclature

$b$	: Electrode width
$h$	: Electrode height
$L$	: Electrode length
$\Delta P$	: Pressure drop of total
$\Delta P_{ER}$	: Pressure drop by Electric Field
$\Delta P_{\mu}$	: Pressure drop by viscosity
$Q_t$	: Flow rate of Total
$\mu$	: Viscosity of ER fluid without electric field
$\tau_y(E)$	: Yield shear stress

\* Corresponding Author,

**E-mail :** changtae@kyungnam.ac.kr

**TEL :** +82-55-249-2613; **FAX :** +82-55-249-2617

Department of Mechanical and Automation Engineering, Kyungnam University, 449 Wolyoung Dong, Masan, Kyungnam 631-701, Korea. (Manuscript Received March 3, 2005; Revised June 30, 2005)

### 1. Introduction

A valve is a hydraulic device that can change the force transmitted through actuators, and is the most elementary and important constituent of a hydraulic system. Because existing valve systems consist of precise and complicated components, valves have a response delay when they open and shut. The valve (here after called the ER Valve), which is actuated by ER fluid, only needs electrodes to control the flux and pressure of the passing fluid, so that the spool and valve can be designed as a single structure. Furthermore, the strength of the electric field can be used to control the flux and pressure of the fluid passing through the ER Valve, and thus control the position and

velocity of the actuator. By using high speed response and function quick response hydraulics, quick controllable hydraulic equipment can be developed.

An application study on the control system of ER Valve has satisfactorily shown that the what is the most appropriate, applicable equipment. The application cases have been taken from home and abroad.

Yokota and Kondoh (1996), who developed a 2port ER valve, investigated the characteristics of the pressure drop at the inlet and outlet of the valve and the characteristics of the flux, which depended on the electric field strength. Strandrud (1966) applied this result in the adjustment of the piston speed on a vibration tester with electrodes installed inside the cylinder. Simmonds (1991) manufactured and operated cylinders, which used diaphragms with the bridge of several electrodes. Choi and etc. (2004, 2003) manufactured ER Valves and investigated the positioning control of the cylinder system and the automatic loading and unloading system. Chang et al. (2004) studied the characteristics of ERF between two parallel-plate electrodes by using PIV technique. Jang (2003, 2004) manufactured 4 kinds of ERF valves with identical surface area but varying length and width of the plate and then he researched the flow pressure drop using a pressure differential of strain gauge.

Although the application of ER Valve in several fields has been studied, there have been no durability tests and comparison of the ER valve system with the existing valve system.

In this study the minute pressure drop of the ER fluid, which passes through internal clearances of the valve, was investigated according to the electric field strength and the number of electrodes. The control characteristics of FHA (flexible hydraulic actuator) was evaluated with an industrial controller circuit, which consisted of an ER valve system and existing valve system. And after the durability test of the ER fluid, which examined electrode consumption and etc., the effectiveness of ER Valve and FHA was proven.

## 2. ER Valve Manufacturing and Fluid Flow Characteristics

Figure 1 and Photo. 1 show the total configuration layout and internal structure of the ER Valve designed and manufactured in this study. This valve consists of 11 flow channels with 12 electrodes whose clearances are 1.5 mm. The internal electrode plates are made of copper, which has excellent electric conductivity. Plastic covers are placed on the top and bottom of the electrodes, fixed with 6 mm-diameter epoxy bolts. To prevent ER fluid leakage, silicon rubber was

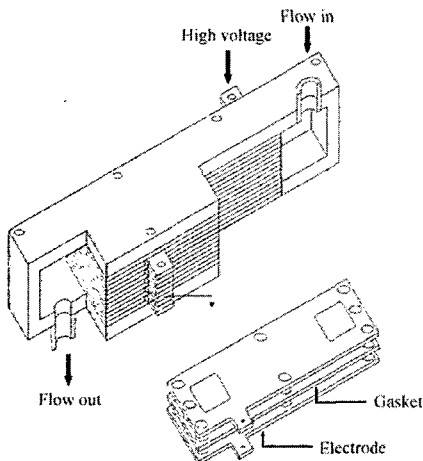

(a) Configuration of ER Valve

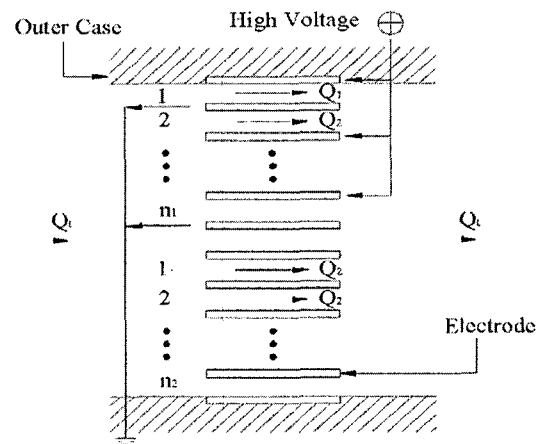

(b) Flow characteristics of ER Valve

**Fig. 1** Schematic configuration of ER Valve

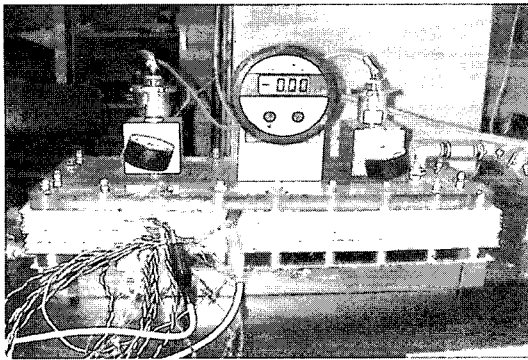

(a) ER Valve

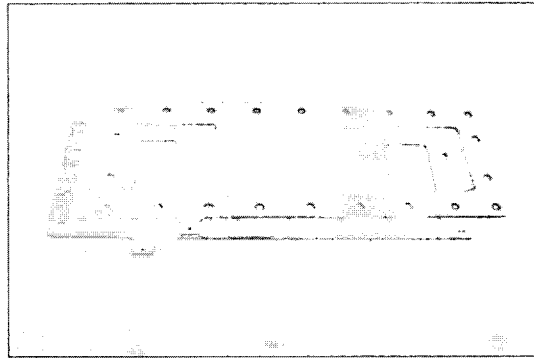

(b) Electrode and silicone rubber

**Photo. 1** The manufactured ER Valve

inserted between the electrodes. Each electrode acting as a (+) and (-) electrodes connected to a high voltage generation device. ER fluid is introduced and flowed into the clearance between the (+) and (-) electrode plates. Then electric field is applied to the valve to generate the ER effect.

As shown in Fig. 1(b), when electric field is not applied to the ER Valve, ER fluid acts as Newtonian. If electric field is applied, the particles of the ER fluid tend to cluster, and ER fluid will develop characteristics of Bingham fluid, which shows us to increase yield shear force. When electric field is applied to several electrodes as that in Fig. 1(b), there are fluid passages, which is applied to by electric field and not done. (unclear) Therefore, when fluid flows into the ER Valve, pressure drop  $\Delta P$  can be expressed as follows.

Pressure drop with applied electric field,

$$\Delta P = \Delta P_{\mu 1} + \Delta P_{ER} = \frac{12\mu L Q_1}{bh^3} + \frac{2L \tau_y(E)}{h} \quad (1)$$

Pressure drop without applied electric field,

$$\Delta P = \Delta P_{\mu 2} = \frac{12\mu L Q_2}{bh^3} \quad (2)$$

Here,  $Q_1$  stands for the flux passing through the fluid passage applied by electric field, and  $Q_2$  stands for the flux passed through fluid passage not applied by electric field.

The continuity equation is used obtain the total flux ( $Q_t$ ), which passes through the ER Valve as follows.

$$Q_t = n_1 Q_1 + n_2 Q_2 \quad (3)$$

where,  $n_1$  is the number of fluid passages applied by electric field and  $n_2$  is the number of fluid passages not applied by electric field. When there are many ER fluid passages, through which the ER fluid from the ER Valve passes,  $Q_1$  and  $Q_2$  of equation (3) can be changed by  $n_1$  and  $n_2$ .

Equation (3) is arranged by  $Q_2$  as follows.

$$Q_2 = \frac{Q_t - n_1 Q_1}{n_2} \quad (4)$$

When equation (4) is inserted into equations (1) and (2) and arranged,  $Q_1$  is as follows.

$$Q_1 = \frac{1}{n_1 + n_2} \left[ Q_t - \frac{n_2 b h^3}{12 \mu L} \Delta P_{ER} \right] \quad (5)$$

where, equation (5) is inserted into equation (1) and rearranged, and then the pressure the drop of ER valve is as follows.

$$\Delta P = \left( \frac{1}{n_1 + n_2} \right) \left[ n_1 \Delta P_{ER} + Q_t \cdot \frac{12 \mu L}{b h^3} \right] \quad (6)$$

When the number of the fluid passages in equation (6) is increased, the number of electrode plates, which are applied by electric field, is increased. And total pressure drop  $\Delta P$  at the entrance and exit of the ER valve is also increased. Without applied electric field,  $n_1$  becomes 0, and therefore, the total pressure drop is due only to the viscosity of the ER fluid. But when electric field is applied to all passages (,)  $n_2$  becomes 0, and the total pressure drop is expressed by equation (1).

### 3. The Layout of ER Valve and FHA and Experiment Method

The experiment apparatus of the ER valve and FHA of this study is shown in Fig. 2(a) and Photo. 2(a). The ER fluid is made of silicone oil (50cSt) and starch powder (35 wt%). It is pumped by the Trocoid pump, whose max. flow rate is 7.5. The motor is operated at 1800 rpm, 3 ph ac, and 220v. The pressure and flow rate were investigated according to the electric field strength and the number of electrode plates. At a step of 0.5 kV/mm, the electric field was increased to 0~4 kV/mm. Inlet and outlet holes are drilled on the top plate of the ER Valve. The pressure difference gauges are connected from these holes.

The pressure difference gauge (SDT-D12K, ULFA TECH. Co. LTD) can measure pressure difference of 0~10 kgf/cm<sup>2</sup> with output voltage 0~5 kV. The pump was adjusted to the output pressure of 5 kgf/cm<sup>2</sup>. Displacement is measured by a displacement sensor (LVDT), which is installed at the end of FHA, in case electric field is applied and not.

To compare the control characteristics of the ER Valve with FHA with what, an experiment apparatus composed with industrial controller (PLC) circuit on the existing valve system as shown in Fig. 2(b) and Photo. 2(b), respectively, was used. The PLC circuit is widely used and its control logic can be easily changed by simple programming. It is also low cost, high reliable, extraordinary expansible and simpler in circuit

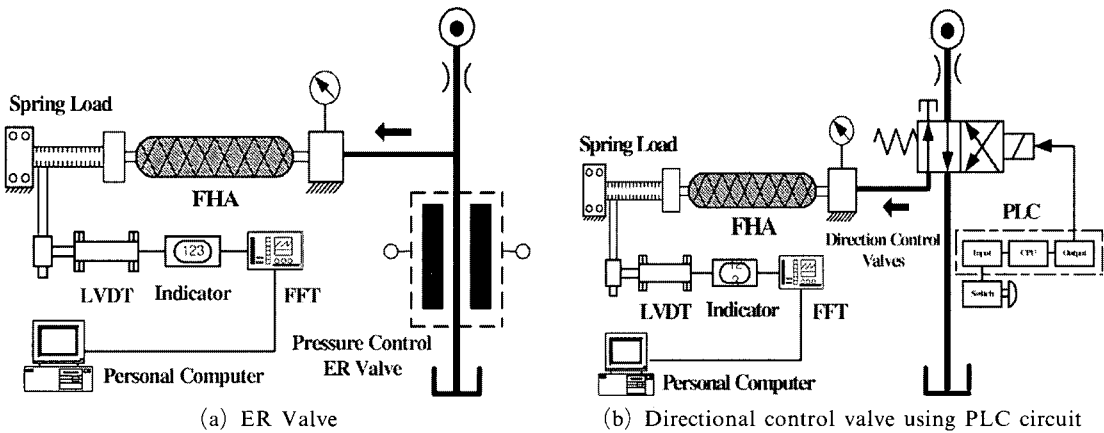
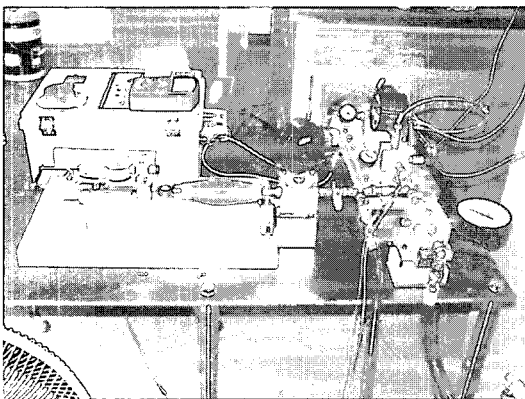
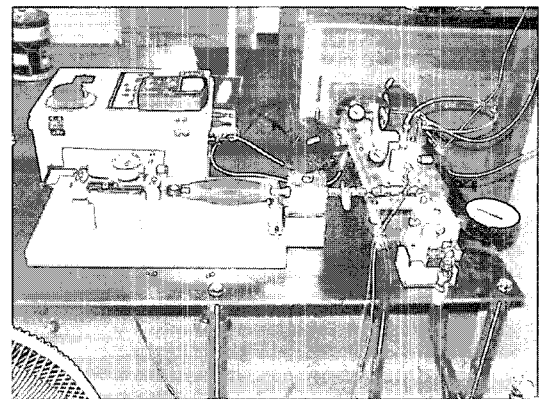

Fig. 2 Experimental apparatus of ER Valve and directional control valves by using PLC



(a) ER Valve



(b) Directional control valve using PLC circuits

Photo. 2 Experimental apparatus of ER-Valve and directional control valves

structure than a general circuit. It can make comparatively precise time measurement to the variance of 1/1000 second. For these reasons, PLC is applied in this study. However, within the existing valve system, the direction control valve (DG4V-5-8C-M-P7L-H-7-40, TOKIMEL Inc.,) has four ports and two positions with a response speed of 5 ms. This experimental work was performed with an optimum hydraulic oil temperature of 40°C for the oil pressure system and employed the average temperature from three measured results.

Figure 3 explains the operation rule of the FHA in the experimental apparatus shown in Fig. 2(a) and Photo. 2(a). FHA is used in this study because FHA has no leakage, drive unit, and can

not destroy the ER particle different from cylinder operation (what is different from the cylinder operation The ER particle). And also FHA can be controlled by internal pressure. When the internal pressure is increased, FHA compresses, and when decreased, it expands due to the spring action. That is, when ER valve is not applied by electric field, fluid flows by the viscosity of the ER fluid itself and FHA expands as shown in Fig. 3(a). However, the ER fluid flowing through the ER valve and applied with electric field builds up clusters. These clusters generate flow resistance and redirect the flow of the ER fluid. Therefore, lots of fluid flows into the FHA, and is compressed. As a result, its internal pressure is increased and its displacement is changed.

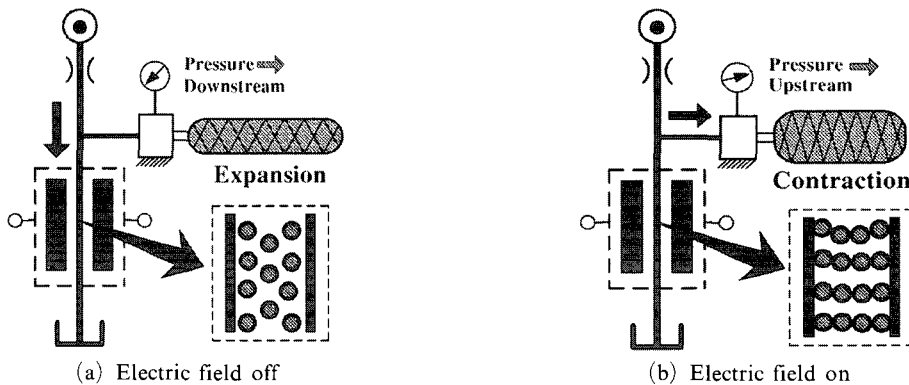
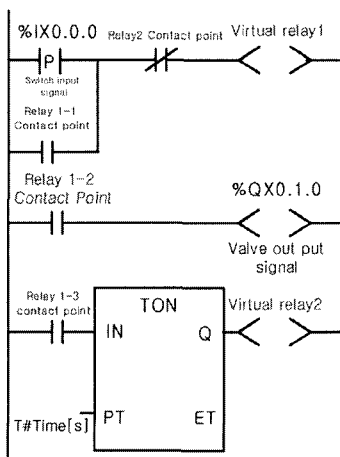
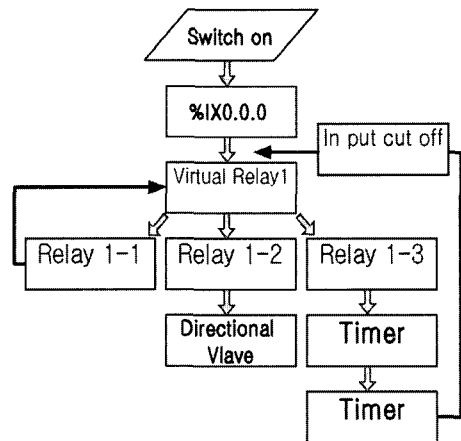

Fig. 3 Schematic of the one-link manipulator by making use of FHA



(a) Industrial controller



(b) Flow chart

Fig. 4 Industrial controller and flow chart of programmable logic controller

The circuit of Fig. 4 measures the displacement, which changes with time from the start of the direction control valve operation to FHA operation after industrial controller is switched on, as shown in Fig. 2(b) and Photo. 2(b).

### 4. Experiment Result and Evaluation

#### 4.1 The characteristics of ER Valve-FHA

Figures 5 and 6 are the graphs which describe the relation between the pressure drop and the electric field strength generated at the ER Valve. The more the electric field strength and the number of electrode plates, which is applied by the

electric field, the more the pressure drop. It is considered why according to the operation rule in ER Valve-FHA of Fig. 3, the more the electric field strength and the number of electrode plate, which is applied by the electric field are increased, the more the number of cluster, which is adhered on the (+) and (-) electrode of ER Valve is increased.

Figures 7 and 8 are the graphs of the relationship between the electric field strength and the flow rate. As shown in Figs. 5 and 6, the more the electric field strength and the number of electrode plate are increased, the more the flow rate is decreased. As explained in Fig. 3, the more the electric field strength and the number of electrode

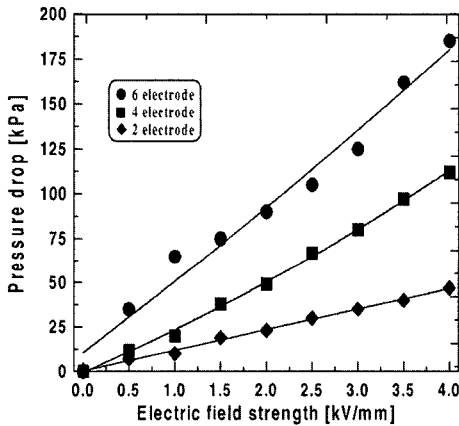

Fig. 5 Pressure drop and electric field strength of ER Valve

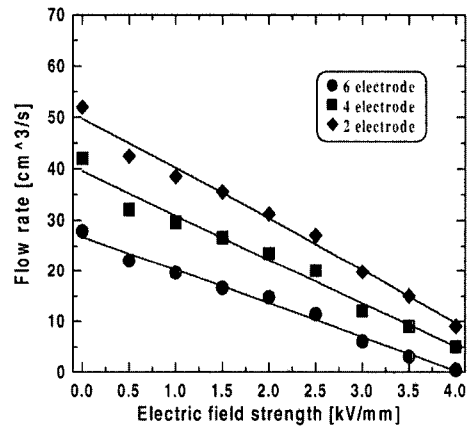

Fig. 7 Flow rate and electric field strength of ER Valve

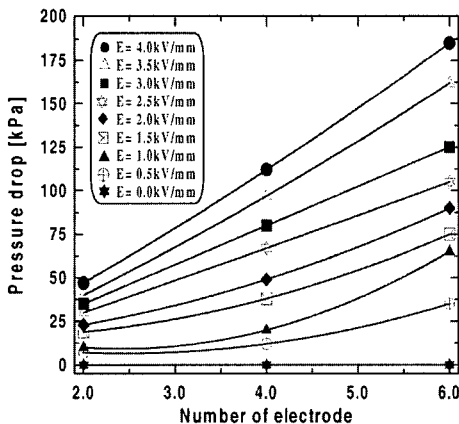

Fig. 6 Pressure drop and number of electrode of ER Valve

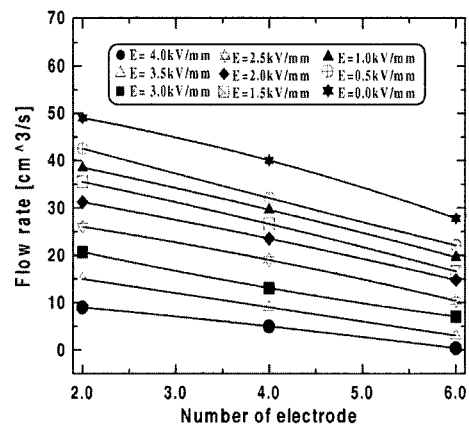
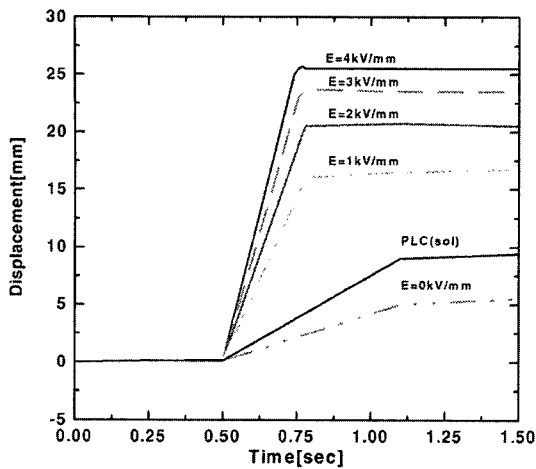
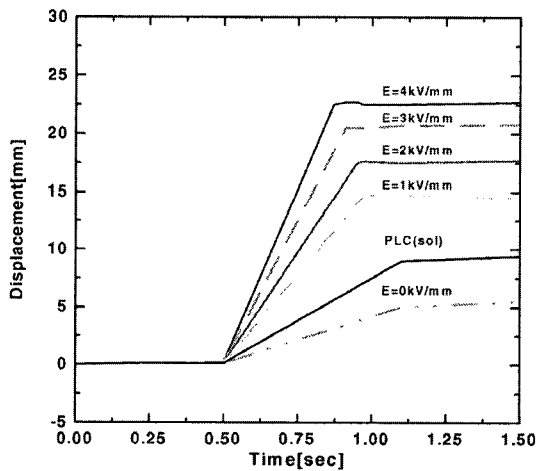

Fig. 8 Flow rate and number of electrode of ER Valve



(a) 6 Electrodes



(b) 4 Electrodes

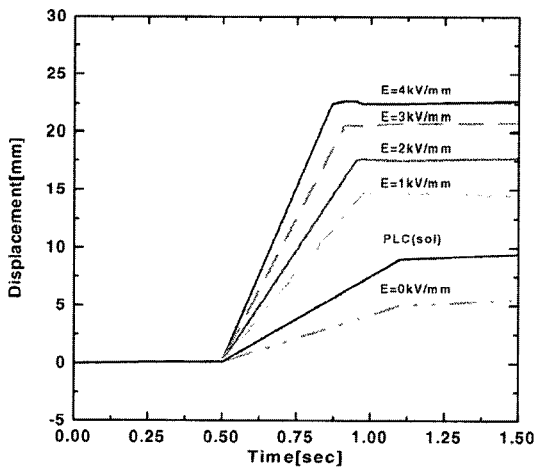

(b) 2 Electrodes

Fig. 9 Control characteristics (response velocity) of ER Valve-FHA

are increased, the more the number of cluster adhered to the (+) and (-) electrode is increased, and therefore, it is thought why flow rate is decreased by the resistance of these cluster. (unclear)

Figure 9(a) ~ (c) are the graph that describes the displacement per time of what, a graph used for evaluating the control characteristics of the ER Valve-FHA with and without applied electric field. In Figs. 5 and 6, 6 electrodes gave the highest pressure drops. As shown in the graphs, the more the electric field strength is increased, the more the displacement of FHA is increased, and the better the response rate. This better response rate is due to the high electric field that when ER effect is increased EHA is compressed by the internal pressure increment of FHA. The displacement and response rate of the valve controlled by an industrial controller, is differently measured from the those of the ER Valve. They differ because the existing valve system has complicated parts such as orifices, spools and etc..

The result of these experiments shows that the displacement and response rate of the ER Valve-FHA does not depend on the complicated parts such as orifices, spools and so on but are controlled by the electric field strength and the number of electrode plate.

#### 4.2 ER fluid and durability of electrode

To apply ER fluid into the application apparatus such as an ER Valve and so on, durability of the Bingham characteristics, electrode consumption and etc. must be evaluated. When ER fluid is used for a long period, the electrodes of the ER Valve may be consumed. The heavy worn area among the ER Valve electrodes is selected as the test piece for the durability test of the electrodes. The roughness variation on the electrode surface is examined by using an optical microscope (Connoscopic Hologram Microscope, CHM-250). Center line average ( $R_a$ ) and ten point height ( $R_z$ ) are measured. Then, the worn application apparatus and so on are believed to change the shapes and sizes of the ER particles. The insulating oil contamination also changes the polarity of ER particles. Therefore, the dur-

ability test of the ER fluid and electrode wear test were performed by using the same experimental apparatus in Fig. 2 (a).

Figure 10 is the graph of the yield shear stress of the ER fluids, which varies according to the electricity strength. (●) means the yield shear stress at the initial state before the durability test, (■) represents after 1000 minutes under an electric field of 1.0 kV/mm and (◆) represents the yield shear stress distribution after 1800 minutes in the same condition as (■). Compared with the initial state (●), yield shear stresses are slightly varied because the ER fluid can not keep constant composition due to ER fluid precipitation in experiment apparatus conduit or contamination and leakage at the connection joint. And then starch particles are broken down by pump movement, and as a result, the amount of polarization reduces when electric field is applied.

Generally, the yield stress with the varying of the oil temperature reported different results with hydrous and anhydrous ERF. This research conducted at 40°C of ERF, the fluid contained silicone oil and starch particles. From this research, we found the yield stress increased according to the temperature change of ERF when increasing the electric field. This phenomenon is considered as the results of the polarization of the particles when increasing the electric field. When the strength of the electric field increased, the moving of the particle and the electric charge in the ERF are increased. Further more, the yield

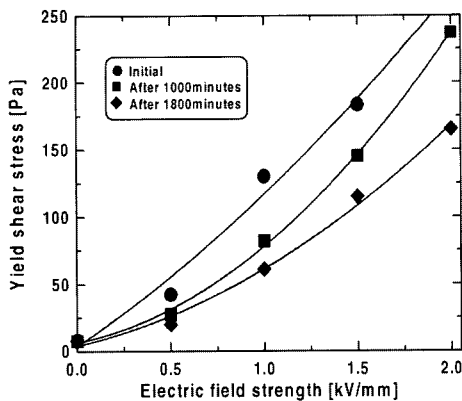

Fig. 10 Yield shear stress of ER fluids with different electric durability test

stress did not increased at 60°C, which is become it restrains the movement of the particle of the ion and the electric charge from a chemical change of the starch particle and the gelatin (e).

Figure 11 describes the initial state before implementing the durability test, and Figs. 12 and 13 describe the surface roughness of electrodes at 1000 and 1800 minutes, respectively, after the test starts. In Fig. 11, centerline average and ten point height are 0.86 μm and 5.98 μm, respectively, and in Fig. 13, centerline average and ten point height are 1.35 μm and 13.15 μm, respectively. After performing the durability test, center line average increased by 1.56 times from that of the initial

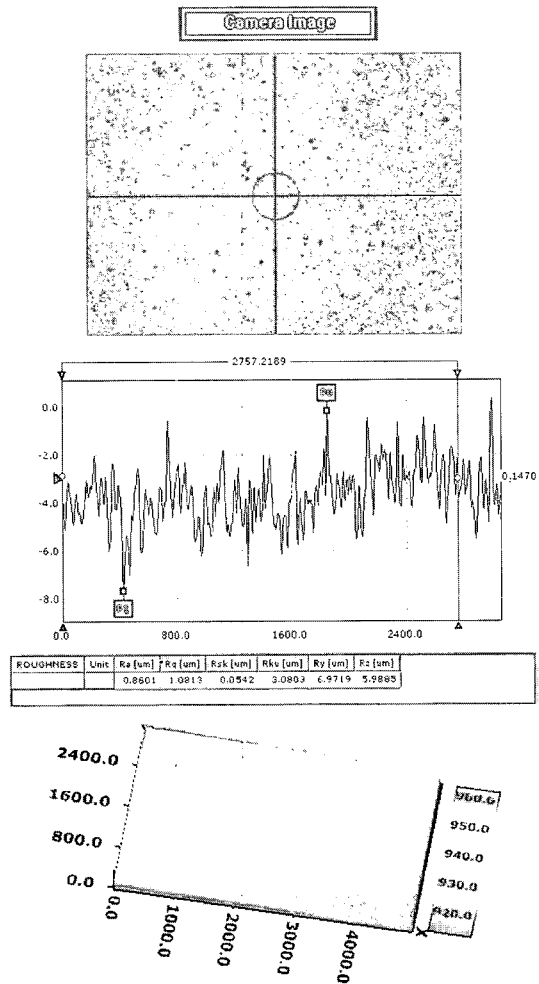

Fig. 11 Electrode surface roughness of ER-Valve (Initial)



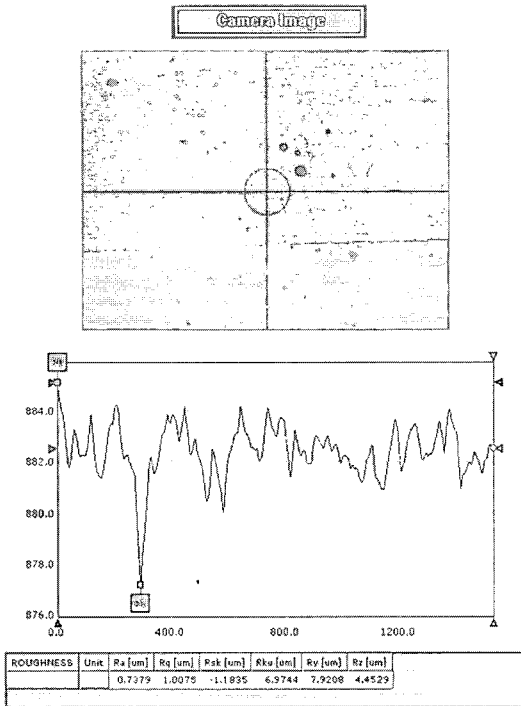

Fig. 12 Electrode surface roughness of ER-Valve (After 1000 minutes)

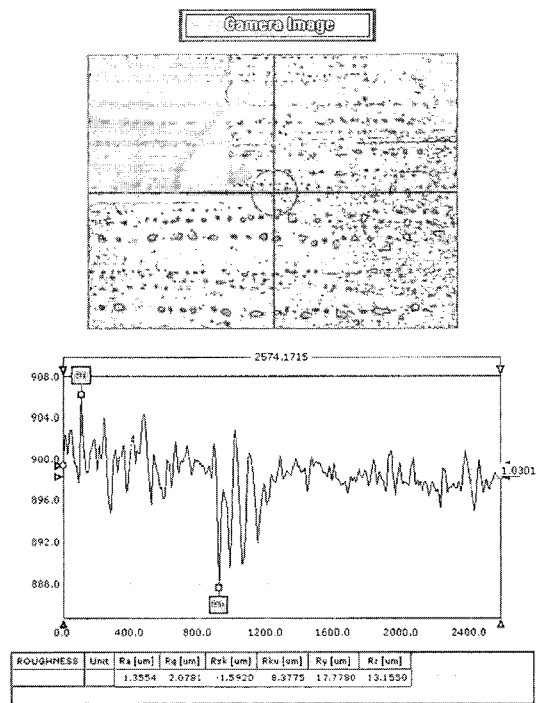

Fig. 13 Electrode surface roughness of ER-Valve (After 1800 minutes)

state and ten point heights increased by 2.2 times. The copper electrodes chemically changed by corrosion due to arc and gelatinization of the starch particles from the fluid temperature rising during fluid movement. It is caused by the oxide film on the electrode surface, which is generated by the reaction between bubbles distributed in ER fluid and copper electrodes. Furthermore, it is supposed that the starch particles transformed by the pump adhere on the electrode surface, and with time, surface roughness is evenly distributed.

The sooted area, which appears on the copper electrode surface in Fig. 13, is different from the area of initial state, as shown in Fig. 11. The

starch particles of the ER fluid adhere to the electrode surface, and they change an electric field density. From these electric field density variations, electric discharge occurs on the copper surface, which has high electric conductivity.

### 5. Conclusions

In this study, the minute pressure drop of the ER fluid, which passes through the internal clearances of the valve, was investigated according to the electric field strength and the number of electrodes. The control characteristics of FHA (flexible hydraulic actuator) was evaluated by

using an industrial controller circuit consisting of an ER and existing valve system. Examining electrode consumption and etc., the durability test of the ER fluid revealed the following.

(1) As the electric field strength and the number of electrode plate increased, the number of clusters, which adhere to the (+) and (-) electrodes of the ER Valve, increased. As a result, the fluid resistance increased and flow rate decreased.

(2) As the electric field strength increased, the displacement and response rate of FHA increased and became better because of the ER effect, which was increased by the electric field, such as the internal pressure increase and compression of FHA.

(3) The displacement and response rate of the valve that uses industrial controllers, are differently measured from those of ER Valve because of the characteristics of existing valve system, which has complicated components such as orifice, spool and etc..

(4) Yield shear stresses slightly varied during the durability test of the ER fluid because the ER fluid can not keep constant composition owing to ER fluid precipitation in the experiment apparatus conduit or the contamination and leakage at the connection joint. Starch particles were broken down by pump movement. It is likely to reduce the amount of when electric field is applied.

(5) After the durability test of ER Valve electrodes was performed, center line average increased by 1.56 times that that of the initial state, and ten point heights increased by 2.2 times. This increase is due to the chemical change of the copper electrodes by corrosion from arc and gelatinization of starch particles from temperature rising during fluid movement.

### Acknowledgment

This work is supported by Kyungnam University research fund, 2005.

### References

Jung, J. M., Choi, S. B. and Cheong, C. C.,

1996, "Position Control of ER Valve-Cylinder System Via Neural Control Technique," *KSAE*, Vol. 4, No. 6, pp. 52~64.

Simmonds, A. J., 1991, "Electro-Rheological Valves in a Hydraulic Circuit," *IEE Proceeding-D*, Vol. 138, No. 4, pp. 400~404.

Strandrud, H. T., 1966, "Electric-field Valves Inside Cylinder Control Vibrator," *Hydraulics and Pneumatics*, pp. 139~143.

Sung-Cheol Jang, Man-Oh Yum, 2004, "Design and Performance Test of Valve Operated by ER Fluids," *KSMTE*, Vol. 13, No. 1, pp. 63~68.

Sung-Cheol Jang, Man-Oh Yum, Do-Tae Kim, 2003, "Flow Rate-Pressure Drop Characteristics of Dispersive ER Fluid According to Change of Electric Field Strength in Clearance between Parallel Plates," *KSMTE*, Vol. 12, No. 1, pp. 78~83.

Sung-Cheol Jang, Man-Oh Yum and Do-Tae Kim, 2001, "The Flow Characteristics of ER Fluids According to the Electrode Shape of Two Parallel-Plate," *Proceedings of the KSME 2001 Spring Annual Meeting E*, pp. 207~212.

Sung, K. G., Chung, D. D. and Choi, S. B., 2001, "Control of Automatic Cargo Handling System Using ER Valves (I)," *Journal of the Korean Society of Precision Engineering*, Vol. 18, No. 9, pp. 53~60.

Tae-Hyun Chang, Sung-Cheol Jang, 2004, "An Experimental Study on Flow Characteristics of ERF Between Two Parallel-Plate Electrodes by Using PIV Technique," *KSME International Journal*, Vol. 18, No. 10, pp. 1763~1771.

Yokota, S. and Kondoh, Y., 1996, "A Control valve by Making use of an ER Fluid," *JSME*, Vol. 62, No. 601, pp. 93~100.

### Simplification of Previous Equations

ER fluid movements, which are generated in the multistage ER Valve, are simplified in Figs. 5-3. Electric field is applied to several electrodes, as shown in the figures, so that both fluid passages are either applied or not applied by electric field. Therefore, when ER fluid passes through the ER Valve, the pressure drop  $\Delta P$  can be expressed as follows.

Pressure drop of fluid passage applied by electric field

$$\Delta P = \Delta P_{\mu 1} + \Delta P_{ER} = \frac{12\mu L Q_1}{bh^3} + \frac{2L\tau_y(E)}{h} \quad (1)$$

Pressure drop without applied electric field,

$$\Delta P = \Delta P_{\mu 2} = \frac{12\mu L Q_2}{bh^3} \quad (2)$$

where,  $Q_1$  stands for the flux passing through the fluid passage applied by electric field, and  $Q_2$  stands for the flux passing through the fluid passage not applied by electric field. When the continuity equation is used, the total flux ( $Q_t$ ), which passes through the ER valve, is as follows.

$$Q_t = n_1 Q_1 + n_2 Q_2 \quad (3)$$

where,  $n_1$  is the number of fluid passages applied by electric field and  $n_2$  is the number of fluid passages not applied by electric field. When there are many ER fluid passages, through which the ER fluid passes from the ER Valve,  $Q_1$  and  $Q_2$  of equation (3) can be changed by  $n_1$  and  $n_2$ .

Equation (3) is arranged by  $Q_2$  as follows.

$$Q_2 = \frac{Q_t - n_1 Q_1}{n_2} \quad (4)$$

When equation (4) is inserted into equations (1) and (2) and arranged,  $Q_1$  is as follows.

$$Q_1 = \frac{1}{n_1 + n_2} \left[ Q_t - \frac{n_2 bh^3}{12\mu L} \Delta P_{ER} \right] \quad (5)$$

where, equation (5) is inserted into equation (1) and rearranged, and then the pressure drop of the multistage ER valve is as follows.

$$\Delta P = \left( \frac{1}{n_1 + n_2} \right) \left[ n_1 \Delta P_{ER} + Q_t \cdot \frac{12\mu L}{bh^3} \right] \quad (6)$$

When the number of fluid passages in equation (6) is increased, the number of electrode plate, which is applied by electric field, is increased. And total pressure drop  $\Delta P$  at the entrance and exit of the multistage ER valve is also increased. Without the electric field,  $n_1$  becomes 0, and therefore, the total pressure drop is only due to the viscosity of the ER fluid. But when the electric field is applied to all passages,  $n_2$  becomes 0, and the total pressure drop is expressed by equation (1).