

# 계층적 Mobile IPv6를 위한 효율적 멀티캐스트 방안

정희원 김 병 순\*

## An Efficient Multicast Scheme for Hierarchical Mobile IPv6

Byungsoon Kim\* *Regular member*

요 약

이 논문은 HMIPv6를 위해 효율적인 새로운 멀티캐스트 방안을 제안한다. 이동할 영역의 MAP이 멀티캐스팅을 지원하지 않는다면 그 영역으로 이동하는 그룹의 구성원은 그 MAP을 통해 멀티캐스트 그룹에 가입할 수 없게 된다. 따라서 그룹 구성원은 멀티캐스트 패킷을 계속 수신하기 위해, Mobile IPv6를 사용하여 자신의 HA로부터 패킷을 수신한다. 그러나, 이것은 BU 메시지의 전달 지연 시간을 증가시키는 요인이 될 수 있다. 우리가 제안하는 방안은 새 영역의 MAP이 멀티캐스팅을 지원하지 않을 경우, HA에서 패킷을 받지 않고 이전의 멀티캐스트 MAP에서 수신하도록 한다. 제안하는 방안은 터널링 비용, 총 전달 비용, 핸드오버 지연 시간 등을 줄일 수 있다. 전달 비용과 핸드오버 지연 시간 등을 사용하여 M-HMIPv6 방안과 성능을 비교 측정하였다.

**Key Words** : multicast, handover, HMIPv6, M-HMIPv6, HMMIPv6

### ABSTRACT

This paper proposes an efficient multicast scheme for the hierarchical mobile IPv6(HMIPv6). If a mobility anchor point(MAP) in a new domain does not support multicasting, an entering group member cannot join the multicast group through the new MAP. The group member thus keeps receiving multicast packets from its home agent(HA) using Mobile IPv6 (MIPv6). This increases the propagation delay of binding update (BU) messages. However, our scheme enables an entering group member to keep receiving packets from the old multicast MAP. It can also reduce tunneling costs, total delivery costs and handover latency. We simulated the performance of our scheme by comparing it with the seamless multicast handover in a hierarchical mobile IPv6 (M-HMIPv6) using the delivery cost and handover latency factors.

### I. Introduction

Mobile IP enables network-application users to transparently roam between wired, wireless, and cellular networks without dropping their connections. MIPv6 [1] enables a mobile node(MN) to move within the Internet topology while maintaining connections between the MN and correspondent nodes(CNs). An MN is always identified

by its home address, which has been assigned to the MN on its home link. An MN entering a foreign network gets a local IP address, the care-of-address(CoA), and it registers with HA and, when necessary, with the CN using BU messages, letting them know its new location so that traffic can be routed to the new location. The CN can send traffic to the MN directly. While MIPv6 ensures reachability and optimizes packet routes, it

\* Computer Education, Andong National University (bsgim@andong.ac.kr)

논문번호 : KICS2005-04-153, 접수일자 : 2005년 4월 13일

\* 이 논문은 2004 학년도 안동대학교 학술연구조성비에 의하여 연구되었음

suffers from signaling overhead and potentially a long handover latency.

For these reasons the Hierarchical Mobile IPv6 (HMIPv6) [2] is proposed to support micro-mobility in MIPv6 in order to minimize the signaling cost using a local agent. In HMIPv6, the MAP is introduced to allow an MN to send a local BU to the local MAP, rather than the HA and CN. Upon entering into a new MAP domain, an MN receives router advertisements(RAs) containing information on one or more local MAPs. Based on this information in the advertisements, the MN forms two CoAs: a regional CoA(RCoA) on a MAP's subnet and an on-link CoA(LCoA)[3]. The MN then registers with its MAP into the MAP's binding cache by sending a BU that establishes a binding between the MN's RCoA and LCoA. Henceforth, the MAP is able to intercept all packets addressed to the MN's RCoA, and tunnels them directly to its LCoA. In addition, the MN informs its HA and current CNs about its new RCoA. When the MN moves within a local MAP domain, it only registers a new LCoA with the MAP, but neither the HA nor CNs need to be informed. Again, this would reduce cost and latency time.

In this paper, we present a new multicast scheme for HMIPv6. Our scheme allows an entering group member to keep receiving packets without any interaction with the HA. If a new MAP does not support multicasting, the group member keeps receiving from the old multicast MAP instead of its HA. Thus, we can reduce delivery cost and handover latency.

In the rest of this paper, we first describe related works in Section 2, and then present our scheme in Section 3. Section 4 discusses a comparison with other approaches for multicasting in HMIPv6. Section 5 concludes the paper.

## II. Related Works

The IETF(Internet Engineering Task Force) proposed two schemes for MNs to receive packets for MIPv6. One is called home subscription,

where an MN joins multicast groups via bi-directional tunneling[4] to its HA, assuming that its HA is a multicast router. In this scheme the HA performs multicast routing by the multicast listener discovery(MLD)[5], and forwards packets to the MN as if it is at home. The other scheme is called remote subscription, where an MN joins multicast groups via a local multicast router on the foreign network. To join groups, an MN sends the MLD listener report messages to the local multicast router on the visited network. The local router gathers group membership information from group members, and forwards packets to them.

In[6], the authors have introduced the concept of the multicast agent(MA) for mobile group members to enhance the remote subscription. This scheme is one of the remote subscriptions with a multicast agent. The MA provides multicasting to mobile group members in multiple foreign networks. To handle mobile group members, the MA joins the groups on behalf of them, and then tunnels packets to its local group members.

Schmidt[7] has introduced the seamless multicast handover in a hierarchical mobile IPv6 environment(M-HMIPv6), an agent-based scheme, to support multicasting for HMIPv6. A mobile group member uses its local MAP as anchor point for multicasting. Thus, all packets arrive at this MAP, and the MAP tunnels them to group members. Also, the MAP collects group membership from its local group members.

Figure 1 shows a group member's mobility using M-HMIPv6. The bold line illustrates the multicast delivery tree, assuming that all MAPs are multicast routers. When the MN, a group receiver, changes location within MAP3 domain, it receives RAs soon and then registers its new LCoA with MAP3; MAP3 will update the new LCoA on its binding cache entry for each RCoA3 and the group. This does not affect the multicast delivery tree.

In case of inter-MAP handover, the MN will also receive RAs in a new domain(step 1). If multicast support is advertised with MAP option

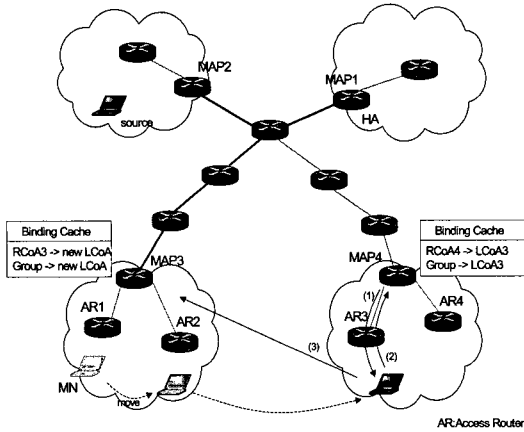

Figure 1. M-HMIPv6 handover

messages in the new domain, the MN should join the group through MAP4. Hence, the MN sends the MLD listener report to MAP4 using RCoA as source address(step 2); MAP4 should record the group information, (Group, LCoA3), in its binding cache so that it can forward packets and preserve group membership. For lossless handover, the MN immediately submits a BU with its new LCoA to the previous MAP, MAP3(step 3). On its reception the previous MAP redirects packets forwarding to the MN's new LCoA. Once packets arrive from the new MAP, the MN should send a BU with zero lifetime to the previous MAP in order to eliminate its Binding Cache entry, and end packet forwarding.

However, if a new MAP does not support multicasting, a group member cannot join the group through its new MAP. In M-HMIPv6 an entering group member establishes a tunnel with its HA using MIPv6 so that the member can keep receiving packets. When a group member receives packets from its HA, handover latency and the propagation delay from the HA to the member increases.

### III. The Hierarchical Multicast Mobile IPv6

We present the Hierarchical Multicast Mobile IPv6 (HMMIPv6) to efficiently support multicasting for HMIPv6. Although a new MAP does not support multicasting, we enable an entering group

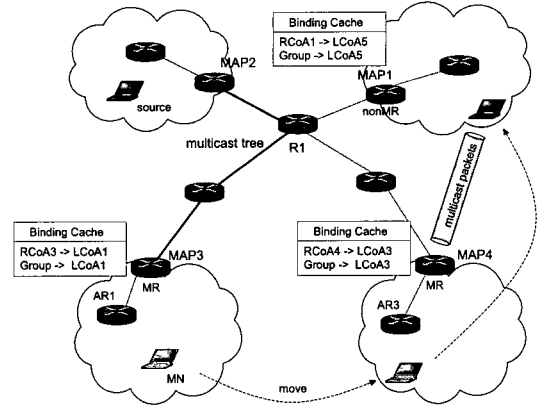

Figure 2. HMMIPv6 scheme

member to keep receiving packets from the old multicast-capable MAP without any interaction with its HA. Thus, if a group member is away from home, its HA does not need to be a member of the group.

Figure 2 shows multicast handover procedure of HMMIPv6. A MAP periodically advertises its multicast capability within the MAP option message; a single bit called M among reserved bits of HMIPv6 is used to indicate whether the MAP supports multicasting. A multicast-capable MAP always maintains a group address and group member list in its binding cache. A group member should maintain its RCoA only if the MAP is a multicast router.

When a mobile group member enters a new domain, it will receive an RA with one or more MAP options. The group member should preferentially register with the multicast MAP among MAPs. If a new MAP supports multicasting like the first handover as shown in figure 2, the MN should join the group through the new MAP, MAP4. When the MAP receives the MLD listener report from the MN, it records the group address and the new LCoA in its binding cache. For lossless handover, the MN then sends a BU with its new LCoA to the previous multicast MAP, MAP3. The previous MAP now forwards packets to the MN's new LCoA. When packets arrive from the new MAP, the MN immediately sends a BU with zero lifetime to the previous MAP not to forward packets. Finally, the MN receives both

unicast and multicast packets through the new MAP, MAP4.

If a MAP does not support multicasting like the second handover, we establish a tunnel between the previous multicast MAP and an entering group member for multicast handover. An entering MN will receives an RA in the new domain. If the new domain does not support multicasting, the MN only carries out unicast handover with the new MAP, MAP1. And for multicast handover, we establish a tunnel between the previous multicast MAP, MAP4, and the MN; the MN sends a BU to the previous MAP. Finally, the previous MAP forwards packets to the MN's new LCoA until it receives a BU with zero lifetime. The MN will receive unicast packets through its new MAP and multicast packets through the previous multicast MAP.

From now on, we will show examples of mobility using HMMIPv6. First, we consider a group member's mobility to a non-multicast MAP. In case of intra-MAP mobility, an MN registers only its new LCoA with the local MAP as shown in (step 1) of figure 3. MAP3 will then replace the old LCoA with the new one for that group address. Thus, a group member's mobility within a local domain is hidden from a multicast tree. When an MN moves from a non-multicast MAP to a non-multicast MAP domain (step 2) in figure 3, the MN cannot join that group through a new MAP, MAP1. Thus, the MN directly sends a BU to its previous multicast MAP, MAP3, using its RCoA as a source address. The previous MAP

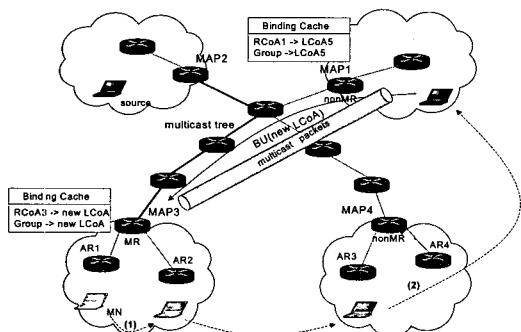

Figure 3. Intra-MAP mobility and mobility to non-multicast MAP

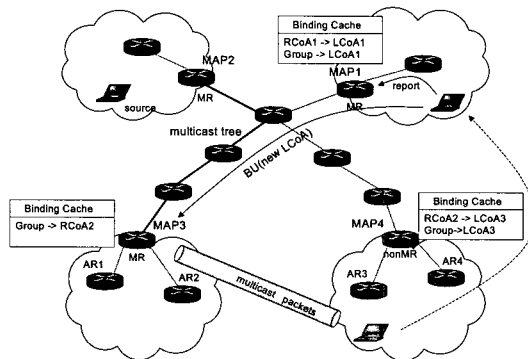

Figure 4. Mobility to a multicast MAP

updates its binding cache entry, and then tunnels packets to the MN in a new domain.

Finally, if an MN moves from a non-multicast MAP to a multicast MAP like figure 4, it can join the group through the new MAP, MAP1. It registers its new RCoA and LCoA with the new MAP for unicasting. Furthermore, it immediately sends out the MLD report to the new MAP in order to join the group, and a BU with the new LCoA to the previous MAP, MAP3. Once the multicast packets arrive from the new MAP, the group member sends a BU with zero lifetime to the previous MAP, MAP3. MAP3 will then delete the group entry from its binding cache.

#### IV. Simulation results

We have evaluated the performance of the proposed scheme using SMPL(Simulation and Modeling Programming Language) [8]. For the performance evaluation of our scheme, we used the network topology as shown in figure 5.

We assumed that all routers of the distribution systems are multicast routers. A source and an MN were randomly selected from MAP domains. The MN's handover formed a Poisson process with an average of 100 seconds and the simulation was performed for 5.0E5 seconds, while the number of non-multicast MAP varies from 1 to 6. Based on this topology, we evaluated both the number of transit links between the source and MN, and handover latency when the source transmitted multicast traffic.

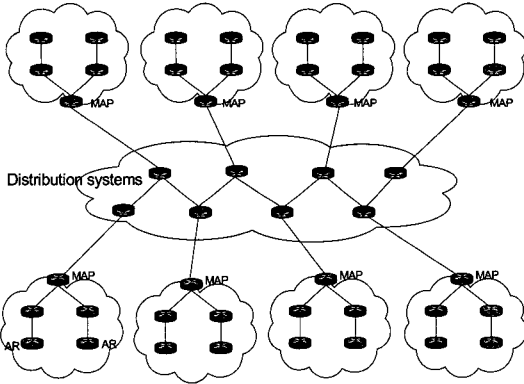

Figure 5. Simulation network topology

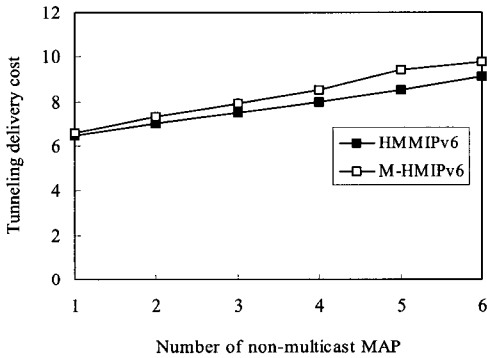

Figure 6. Tunneling delivery cost

Figure 6 shows the tunneling delivery cost for each M-HMIPv6 and HMMIPv6, when the number of non-multicast MAP varies. The tunneling delivery cost is the total number of transit links that a multicast packet travels from the source and the MN via tunneling. We have a relative gain of about 2-11% for HMMIPv6 over M-HMIPv6. The gain increases gradually with the number of non-multicast MAP.

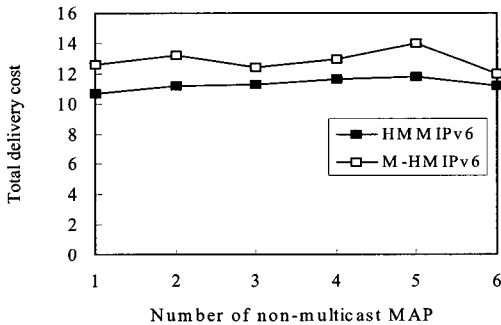

Figure 7. Total delivery cost

Figure 7 shows the total delivery cost for each M-HMIPv6 and HMMIPv6 when the number of non-multicast MAP varies. We describe that the total delivery cost is the total number of transit links that a multicast packet travels from the source to the MN via both tunneling and multicasting. If the total delivery cost is large, the propagation time will be large and it will take more bandwidth. We have a relative gain of about 7-18% in the delivery cost for HMMIPv6 over M-HMIPv6. The gain decreases moderately with the number of non-multicast MAP. When the number of non-multicast MAP increases, it totally affects tunneling cost because the MN receives the packet via tunnel in a new MAP. Therefore, as the number of non-multicast MAP increases, the tunneling delivery cost increases gradually, whereas the multicast delivery cost decreases gradually.

Figure 8 shows the inter-MAP handover latency. We describe that the latency is the number of transit links that each BU and ACK message travels. If a new MAP is multicast router, the latency will be the same. Comparing with M-HMIPv6, HMMIPv6 cause much less handover latency, especially in the case of relatively large non-multicast MAPs. When the number of non-multicast MAP varies from 1 to 4, we have a relative gain of about 2-5% in the handover latency for HMMIPv6 over M-HMIPv6. However, when it varies from 5 to 6, the gain is about 9-19%. As the number of non-multicast MAP increases, the gain increases gradually.

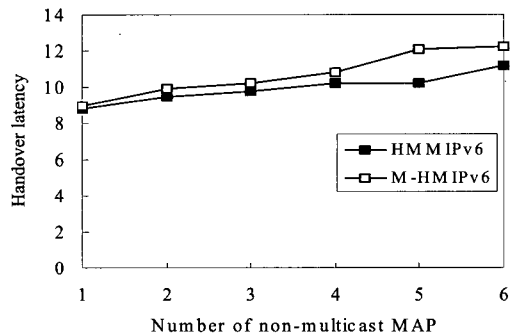

Figure 8. Inter-map handover latency

### V. Conclusion

We have presented a new multicast scheme called HMMIPv6 for HMIPv6. Although a new MAP does not support multicasting, HMMIPv6 allows an entering group member to keep receiving multicast packets from a previous MAP without any interaction with the HA; therefore, if a group member is away from home, its HA does not need to be a member of the multicast group.

We simulated the behavior of HMMIPv6 on a topology with 8 MAPs domain, where each domain has 4 nodes. HMMIPv6 was compared with M-HMIPv6 using different metrics: tunneling cost, total delivery cost and handover latency. Simulation results showed the efficiency of HMMIPv6. Comparing with M-HMIPv6, our scheme had a relative gain of about 2-11% in the tunneling cost, 7-18% in the total delivery cost, and 2-19% in handover latency. For the total delivery cost, as the number of non-multicast MAP increased, the gains decreased moderately, whereas the gains in each the latency and tunneling increased gradually. We can see that our scheme can offer a much lower delivery cost and handover latency.

### REFERENCES

[1] D. Johnson, C. Perkins and J. Arkko, "Mobility support in IPv6," RFC 3775, June 2004.

[2] H. Soliman and K. E. Malki, "Hierarchical Mobile IPv6 mobility management(HMIPv6)," IETF Internet-Draft, draft-ietf-mipshop-hmipv6-04.txt, December 2004.

[3] S. Pack and Y. Choi, "A Study on Performance

of Hierarchical Mobile IPv6 in IP-Based Cellular Networks," *IEICE Transactions Communications*, Vol. E87-B, No. 3. March 2004.

[4] G. Montenegro, "Reverse Tunneling for Mobile IP," RFC 2344, May 1998.

[5] R. Vida and L. Costa, "Multicast Listener Discovery Version 2(MLDv2) for IPv6," RFC 3810, June 2004.

[6] Yu Wang and Weidong Chen, "Supporting IP Multicast for Mobile Hosts," *ACM/Baltzer Journal of Mobile Networks and Applications*, Vol. 6, Feb. 2001, pp. 57-66.

[7] T. C. Schmidt and M. Waehlich, "Seamless Multicast Handover in a Hierarchical Mobile IPv6 Environment(M-HMIPv6)," IETF Internet-Draft, draft-schmidt-waehlich-mhmipv6-02.txt, September 2004.

[8] M.H. MacDougall, "Simulating Computer Systems: Techniques and Tools," MIT Press, 1987.

김 병 순 (Byungsoon Kim)

정회원



1991년 2월 서강대학교 컴퓨터학과 졸업  
 1993년 2월 서강대학교 컴퓨터학과(석사)  
 2003년 2월 경북대학교 컴퓨터공학과(공학박사)  
 1993년 1월~1996년 3월 현대

전자 정보시스템 사업본부  
 1996년 3월~2003년 8월 대구공업대학 컴퓨터정보계열 조교수  
 2003년 9월~현재 안동대학교 컴퓨터교육과 조교수  
 <관심분야> 이동 통신, 멀티캐스트, 교육용 콘텐츠