

# KT - BcN

[KT - Broadband Convergence Network]

2004.2.17

KT Technology Group

1. BcN
2. KT-BcN
3. KT-BcN
4. KT-BcN
5. KT-BcN
6. KT-BcN
7. KT-BcN

1.

# BcN

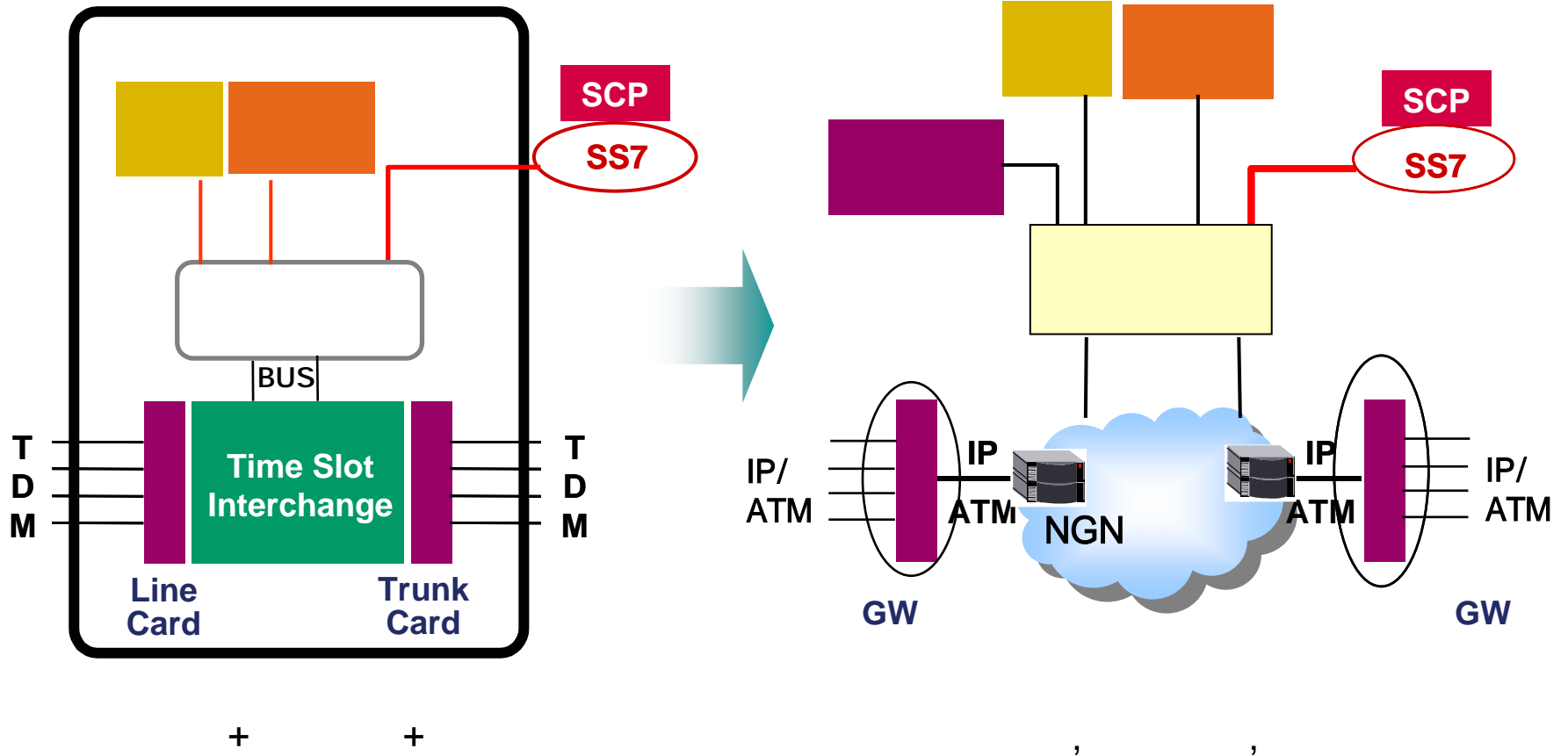

## 2. KT-BcN

### □ CAPEX/OPEX

➤ KT-BcN IP



### □ 가

➤ PSTN, 가



가 가 가

### □



, , , ,

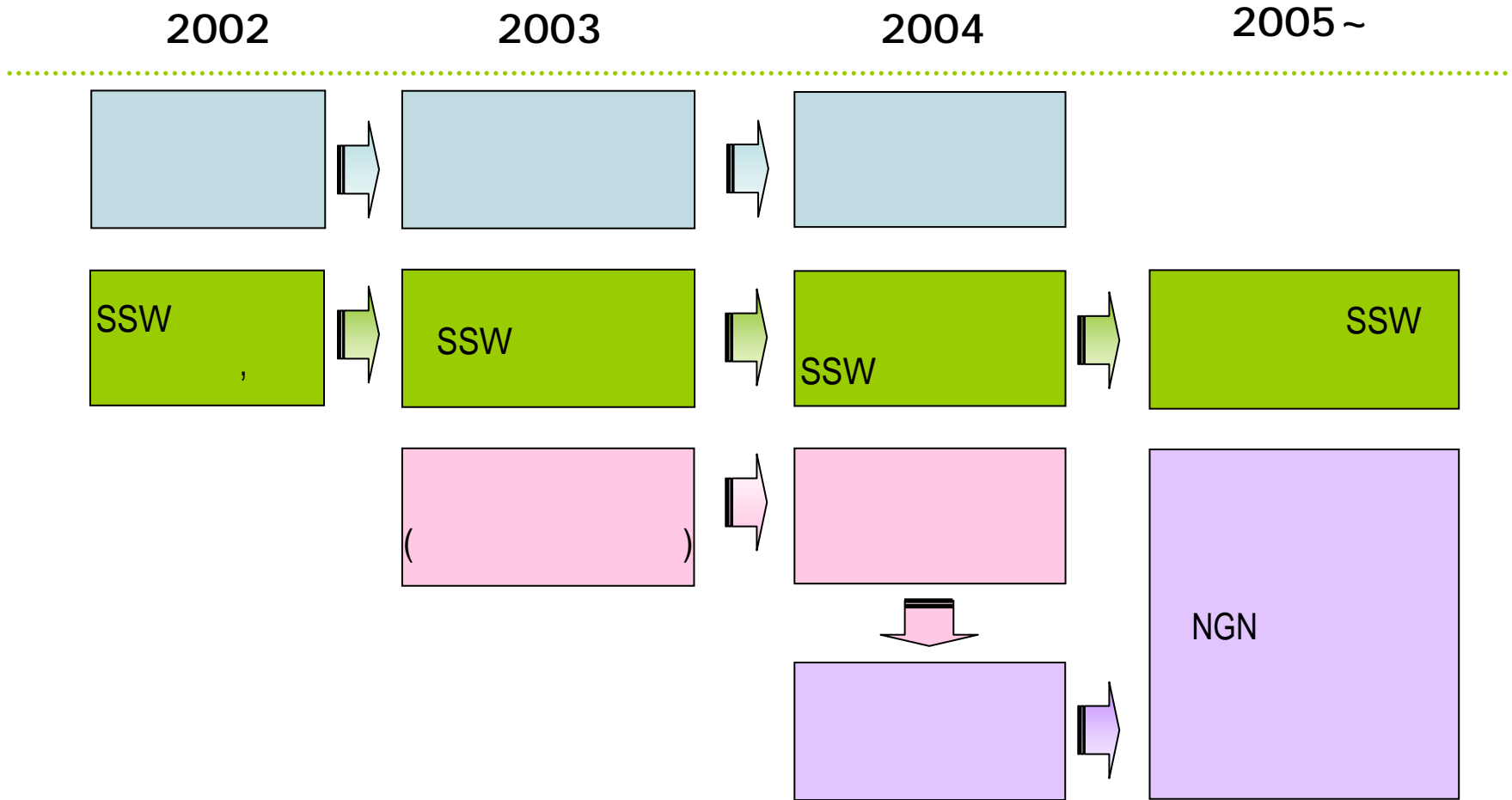

# 3. KT-BcN

- (AGW)
  - GW PSTN BcN  
+ 가
  - PSTN (M10CN, No.1A) , TD GW
  - 3,500 (2002.8 ~ 2003.12)

- - KT-LG (2003.1 ~ 2004.3)
  - - 
    -

- (2003 )
  - :
    - , , PSTN , 가
  - (AS) :
    - 7

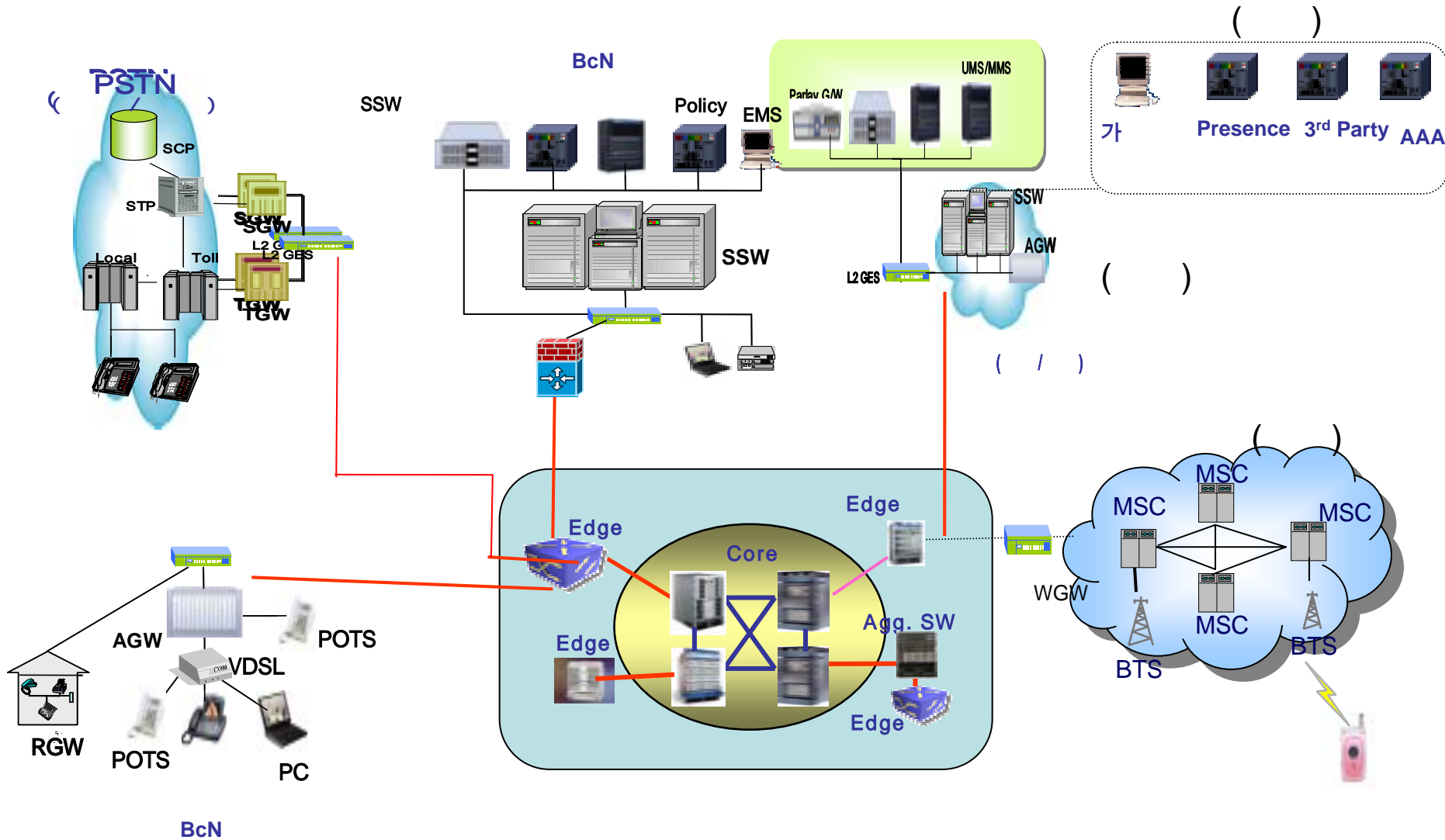

SSW : SoftSwitch, SGW: Signalling Gateway, TGW:Trunking Gateway, AGW : Access Gateway  
 RGW : Residential Gateway, UMS : Unified Messaging Server, MMS : Multimedia Messaging Server  
 AAA : authentication, Authority, Accounting, Agg. SW : Aggregation switch, WGW:Wireless Gateway

- ☐
- 
- ☐
- Access
- ,
- IP 가 ,
- EMS Agent,
- , ,
- 
- PSTN
- SS7 Signaling
- PSTN, AG 가
- IP Multimedia 가
- ☐
- 500 BHCA
- 100 가
- 99.999% , Active/Standby

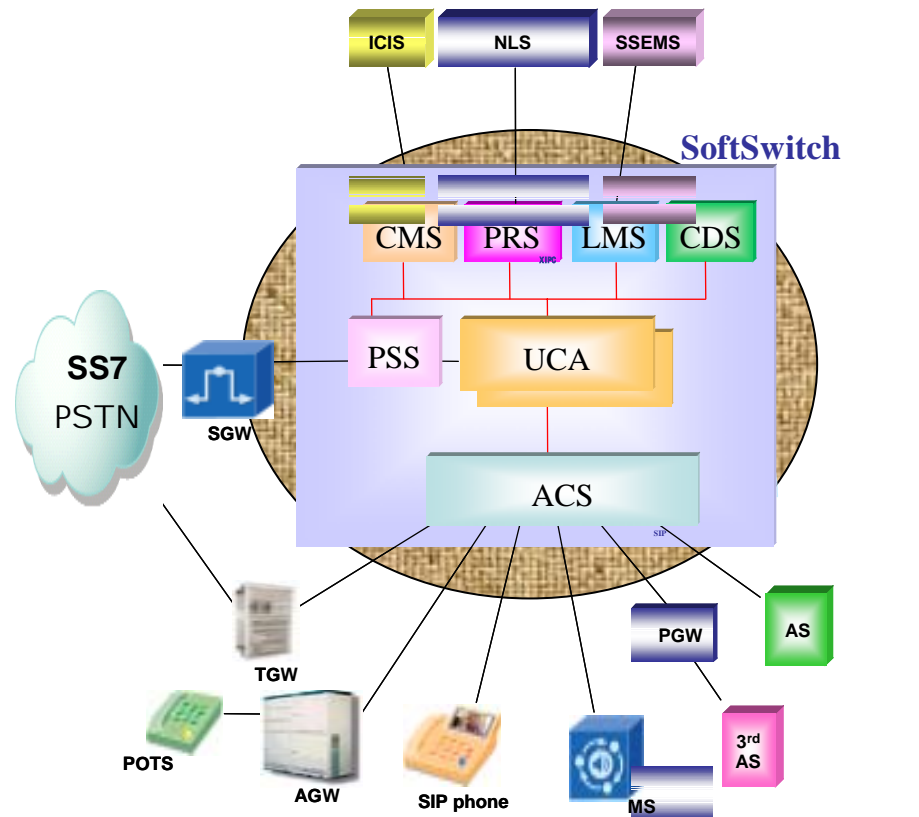

ACS : Access Control Subsystem	NLS : Number Lookup Server
AS : Application Server	LMS : Local Management Subsystem
CDS : Common DB Subsystem	PRS : PSTN Routing Subsystem
CMS : Charging Management Subsystem	PSS : PSTN SS7 signaling Subsystem
LBS : Location Based Service	UCA : Universal Call Agent subsystem
MS : Media Server	ICIS : Integrated Customer Information System



- 가 (POTS, IP-VDSL, Ethernet)
- SSW ,
- Network**

  - /
- (Korea), LG (Korea), (USA)

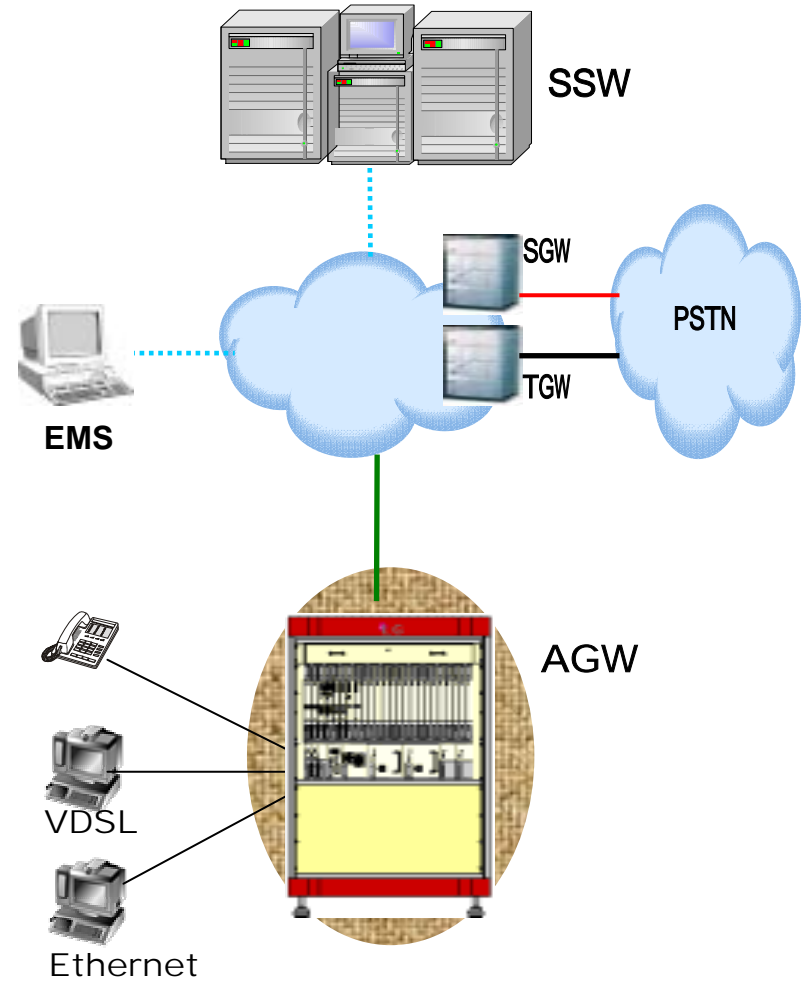



➤ BcN PSTN



➤ TDM to Packet, Packet to TDM

➤ Media



➤ Packet, PSTN



➤ PSTN



➤ (Korea), LG (Korea), (USA)

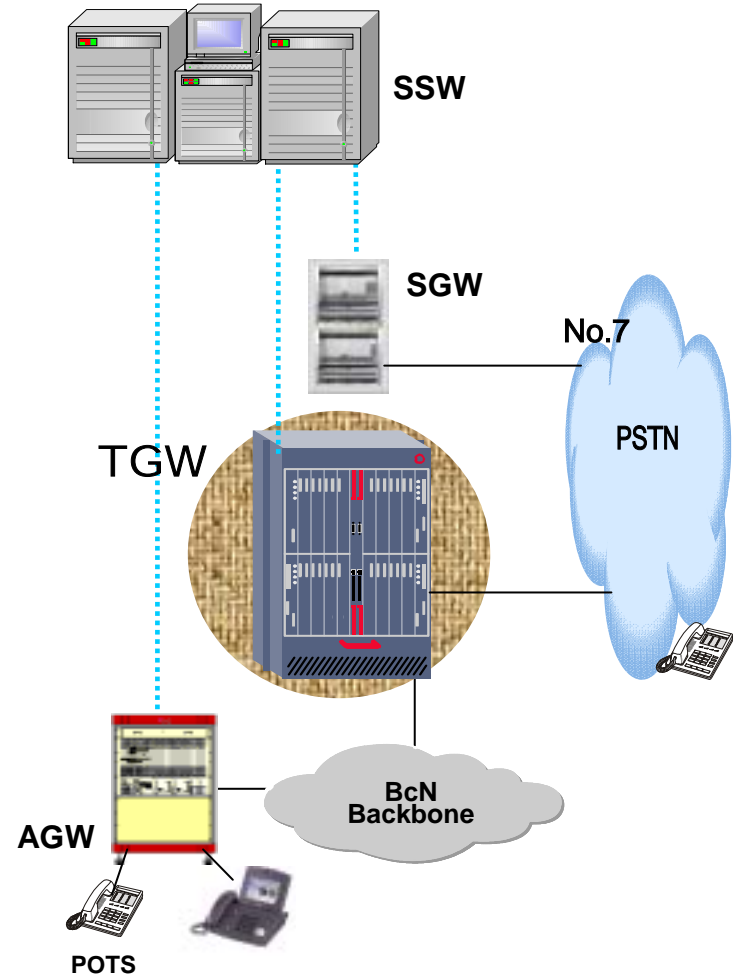

- ❑
  - BcN PSTN No.7
  
- ❑
  - No.7
  - SIGTRAN
  
- ❑
  - PSTN
  
- ❑
  - (Korea), (Korea), (Korea)

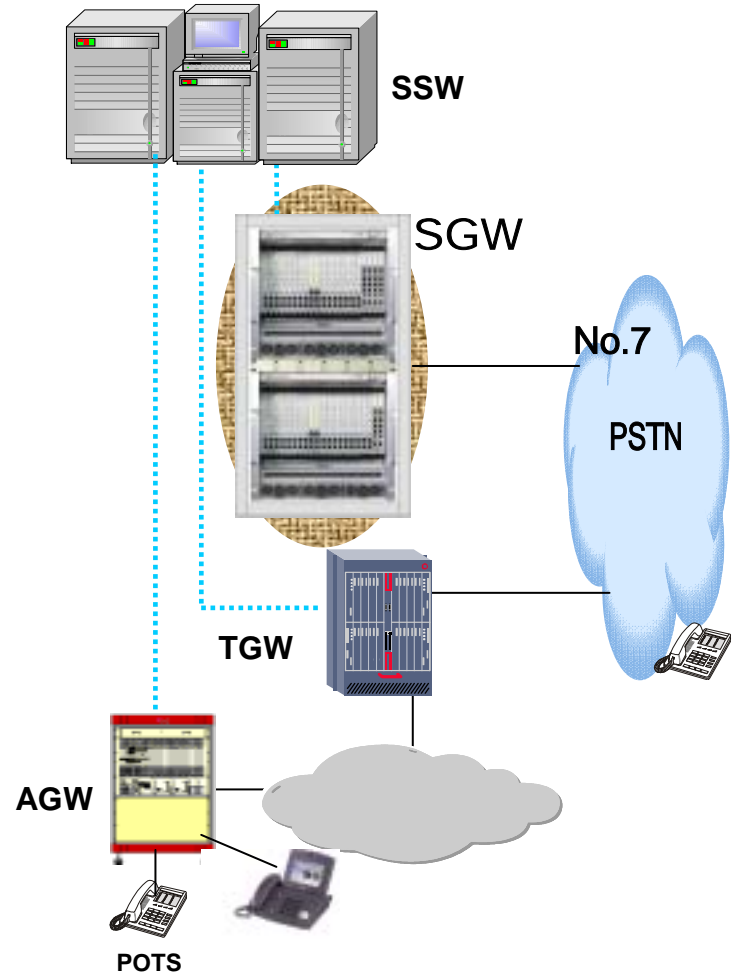

- ☐
  - BcN 가
  - BcN
- ☐
  - SIP / Parlay 가
  - SIP, SIP Extensions
    - Parlay 4.0, KT-INAP
  - - Parlay , SSP, IP
- ☐
  - KT

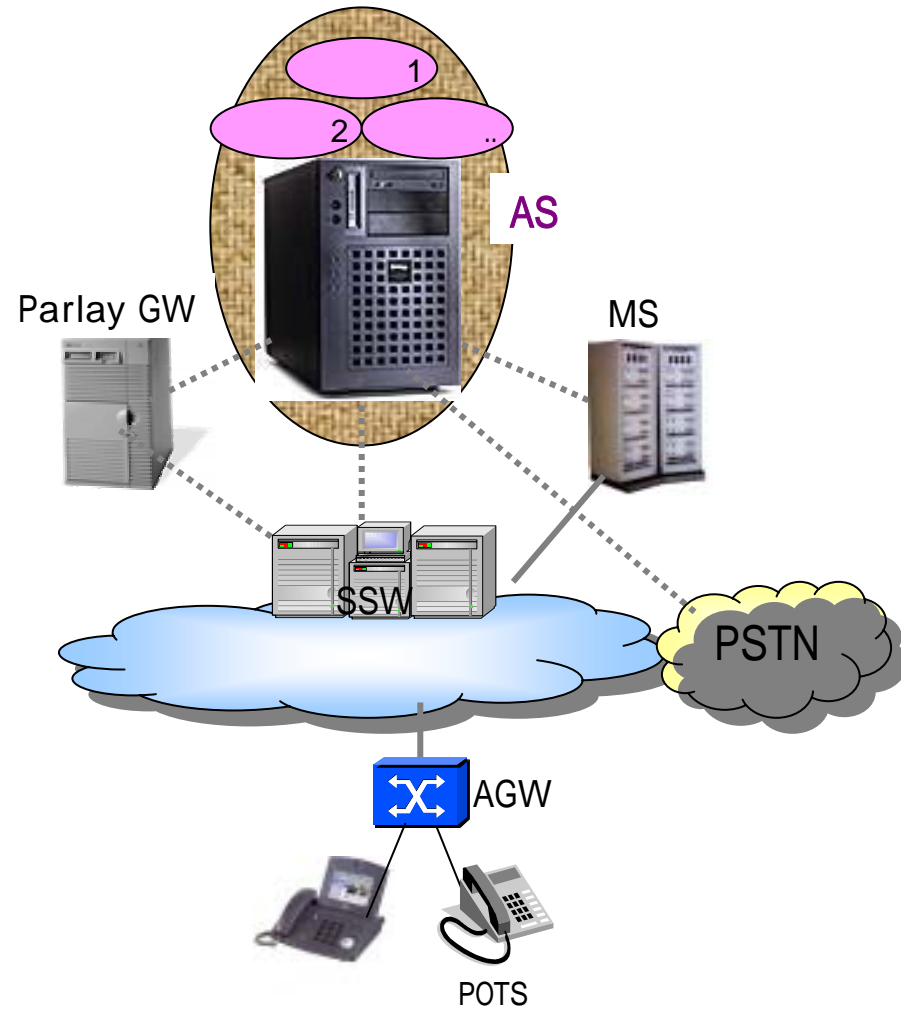

- 
- 
- 
- 
- 
- DTMF
- ASR, TTS, VXML
- 
- 
- : SIP, Megaco
- : AuPackage, XML/VXML
- 
- , , VXML
- Parlay
- 
- (Korea), Dinovan(Korea)

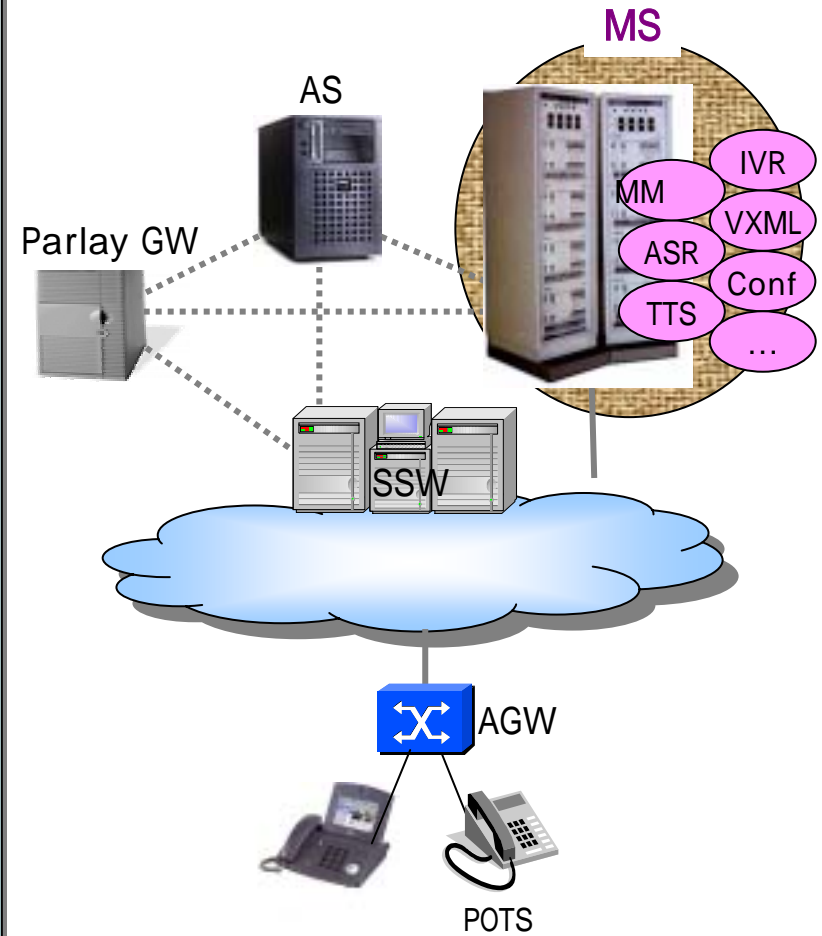

# 5. KT-BcN

가.

		2003	(2004 ~ )
		BcN BcN	가 가 3rd party
SSW	가	' 8 ' 가 ' 가 ' 6 가	SSW 가 IP 가
		PSTN (1588,080,060,1541 )	
		/	/
		Centrex( )	Centrex( )
			080,1588
			VOD, EOD, GOD, , B2B, B2C, , , /가

# 5. KT-BcN

- - BcN 가 , 가
  
- - ( , , , , )
  - 
  - ( , , , )
  
- - PR,
  -

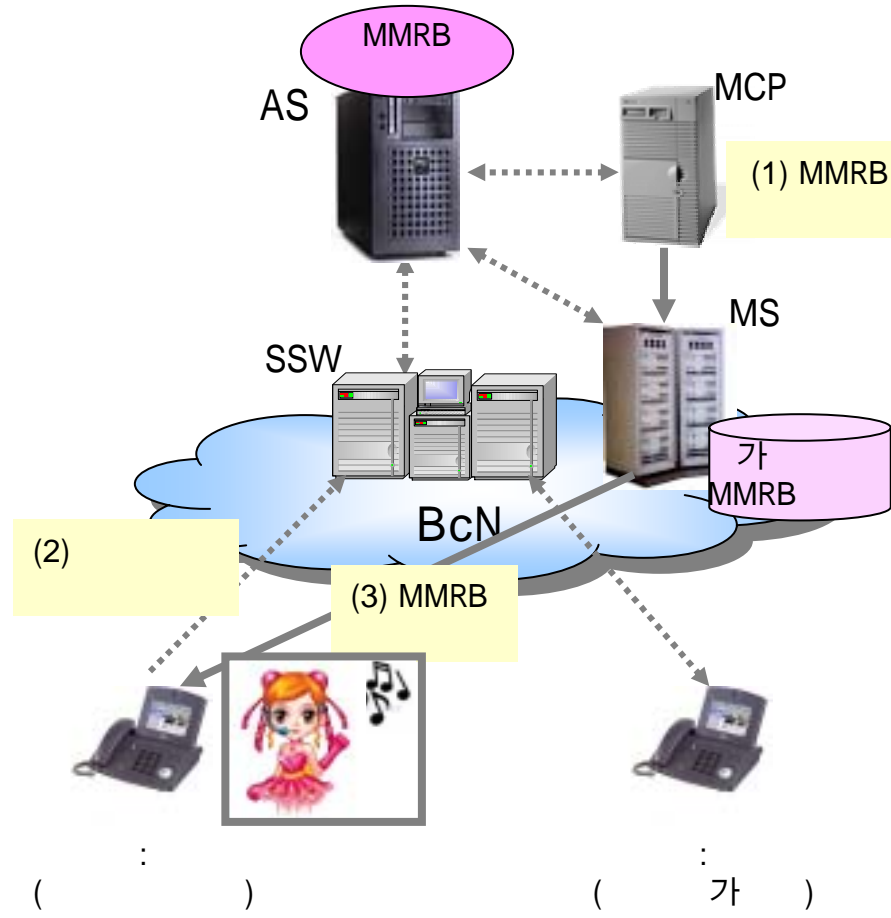

# 5. KT-BcN

- - BcN 가 , 가
  - 가 ( )
- - ( , , , )
  - ( , , )
  - /
- -

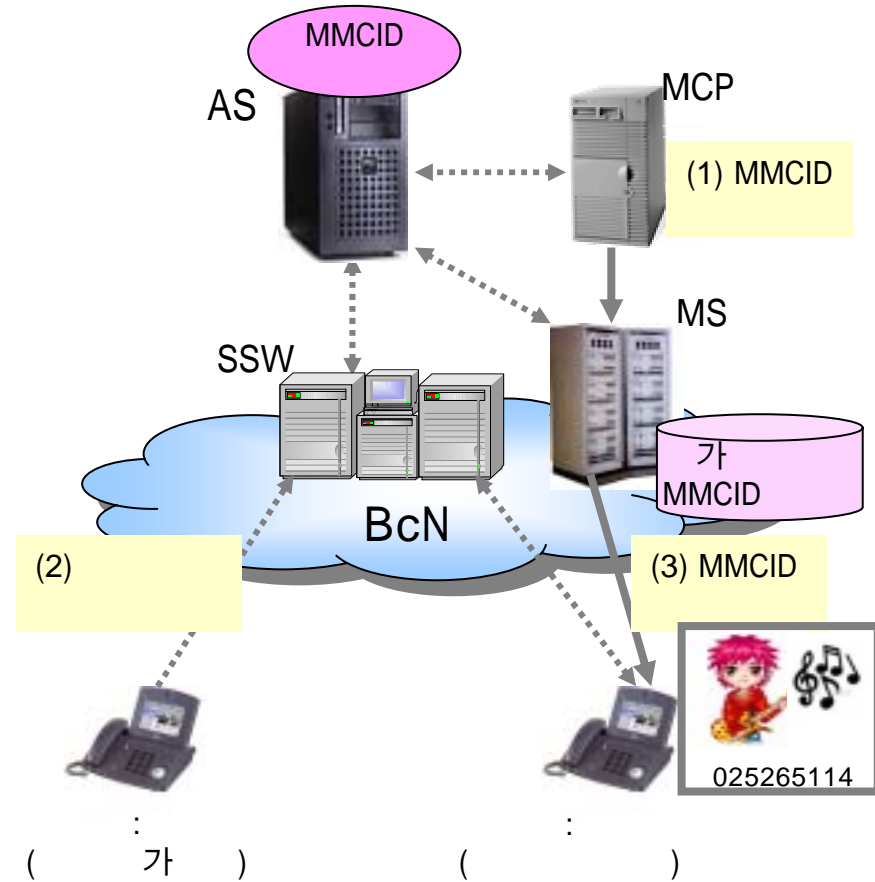



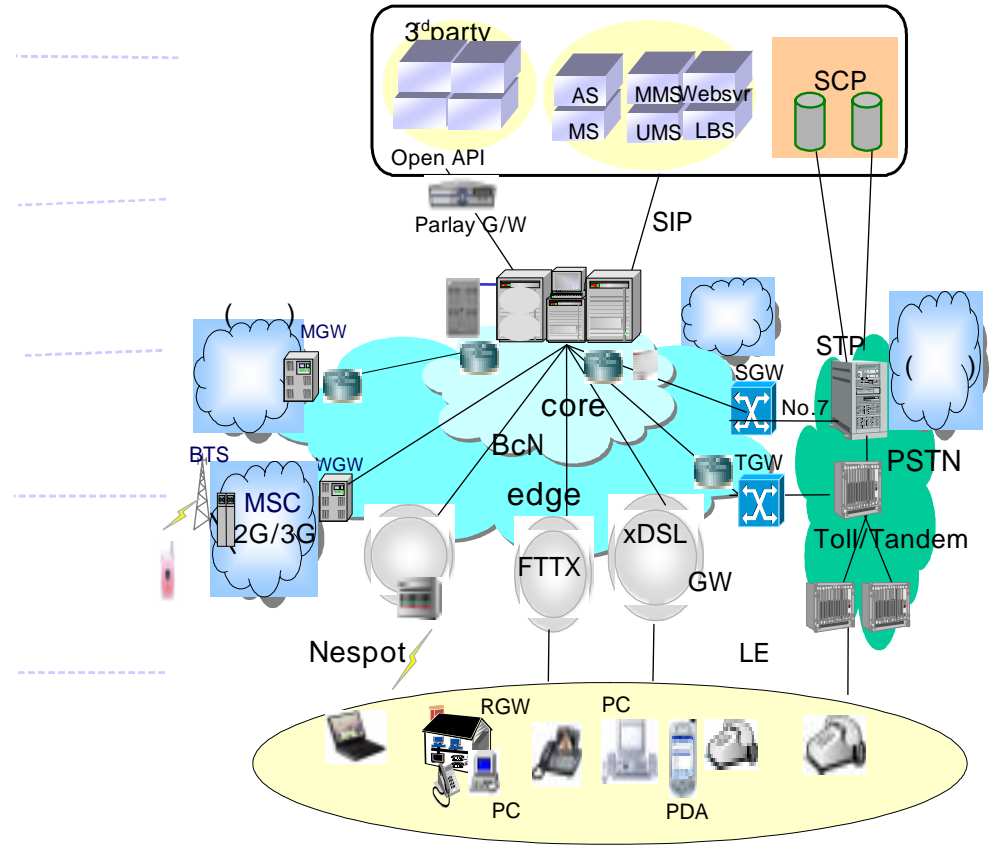
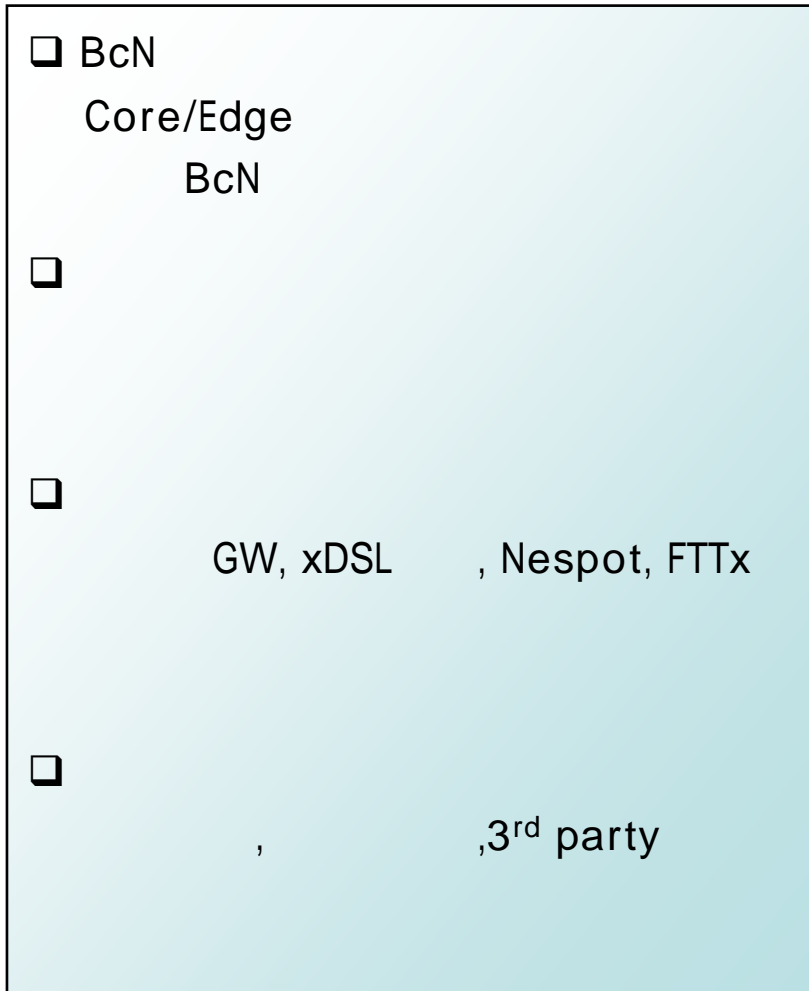

AS: Application Server MS: Media Server UMS: Unified Messaging Server  
 WGW: WirelessGateWay SGW: SignallingGateWay RGW : Residential GateWay

# 6. KT-BcN

## □ BcN

- KT가 (LG )

## □ TGW, SGW, ,

- 
- BMT 가

## □ BcN

- KT가
- H/W,S/W



-

# 6. KT-BcN

## □ KT-BcN

PSTN Seamless

QoS가  
가

- PSTN Seamless
- 가 가
- / 가

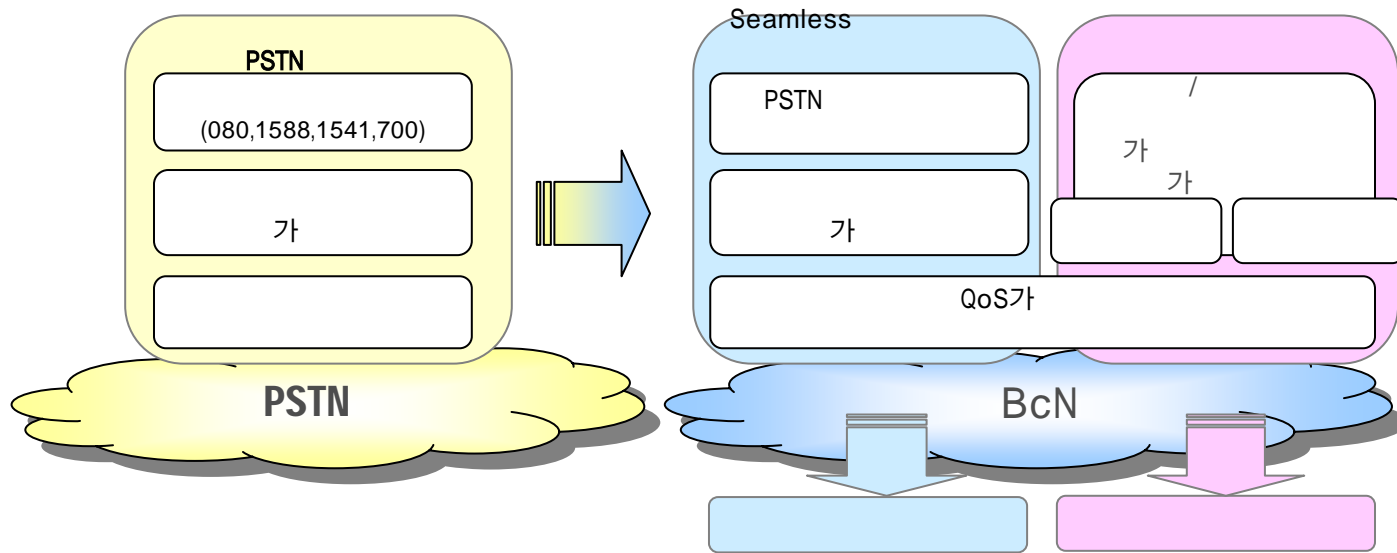

□ 가 +

, +

# 7. KT-BcN

가. 1 (2004~5) :

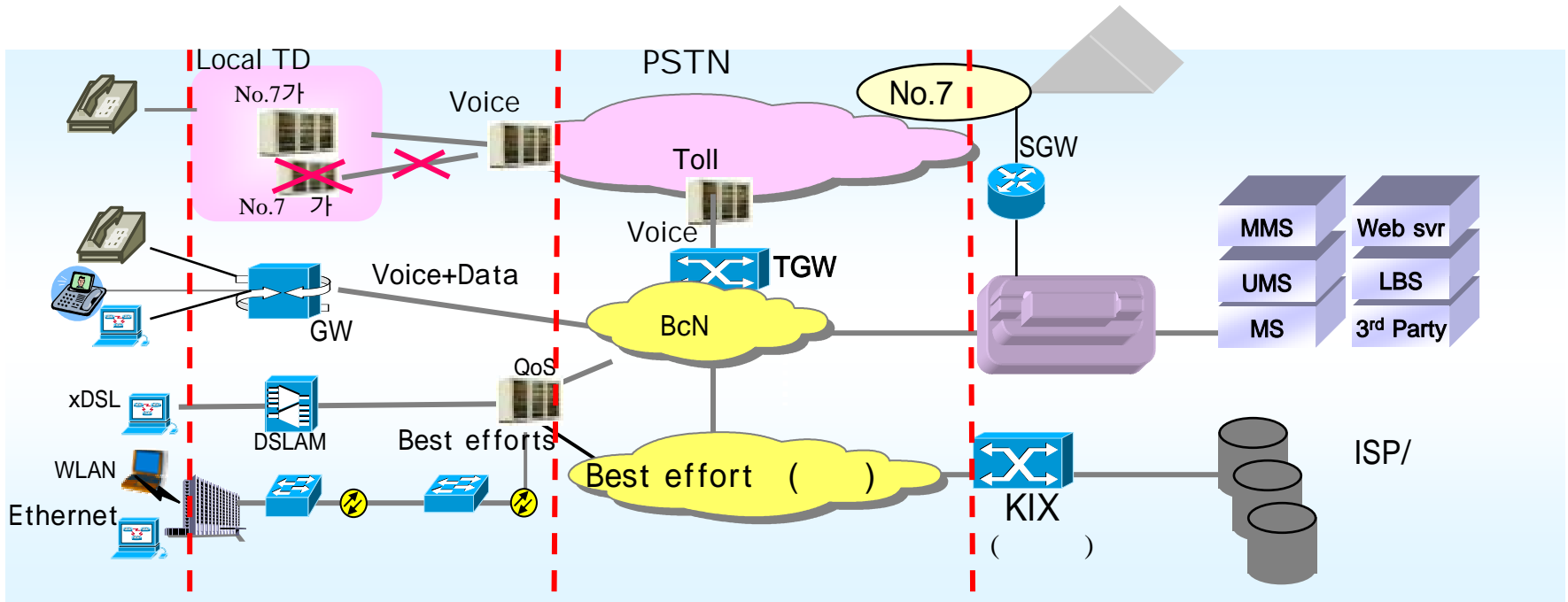

- GW V5.2
- TGW PSTN Toll BcN
- No.7 가 TD GW PSTN No.7 100%
- GW 가 BcN BcN
- 
- QoS BcN

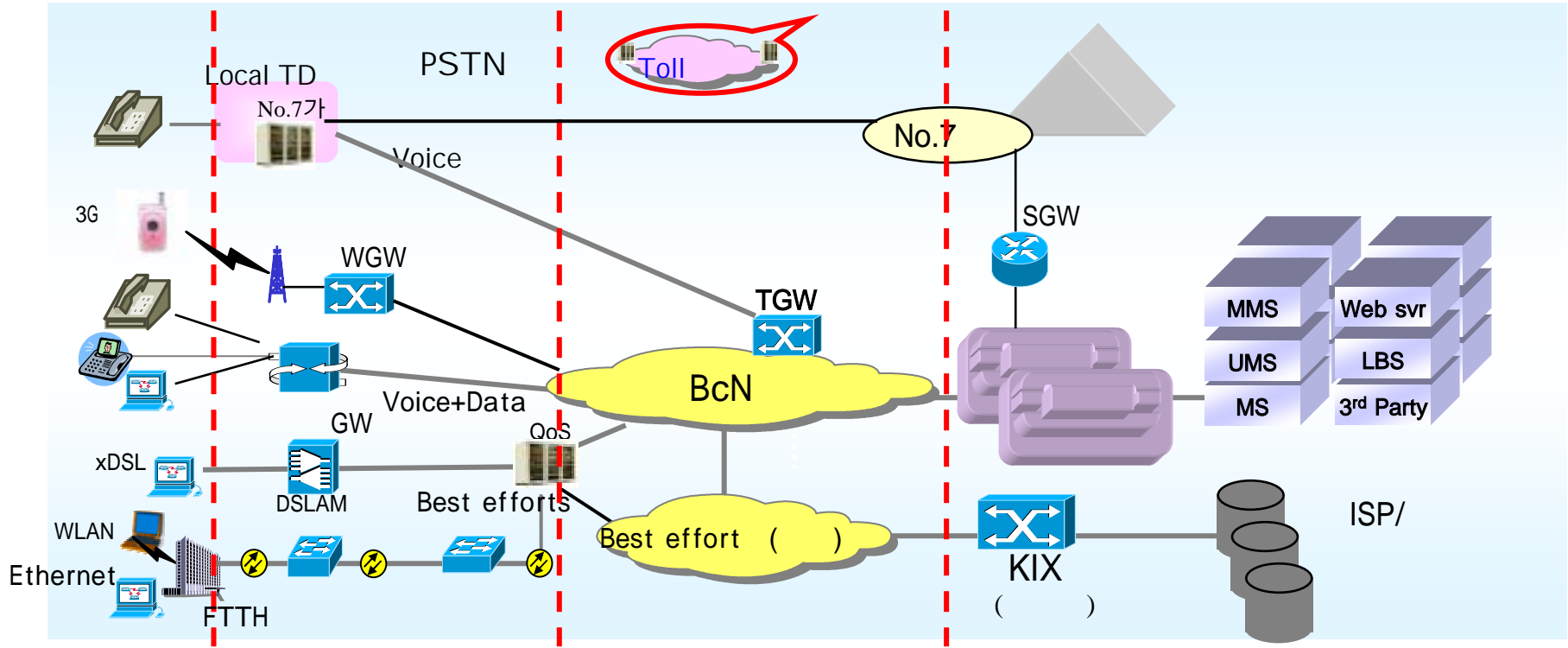

- PSTN Toll
- 3rd Party
- 2.3GHz 가 +
- FTTH , 가 100 +
- BcN IPv6

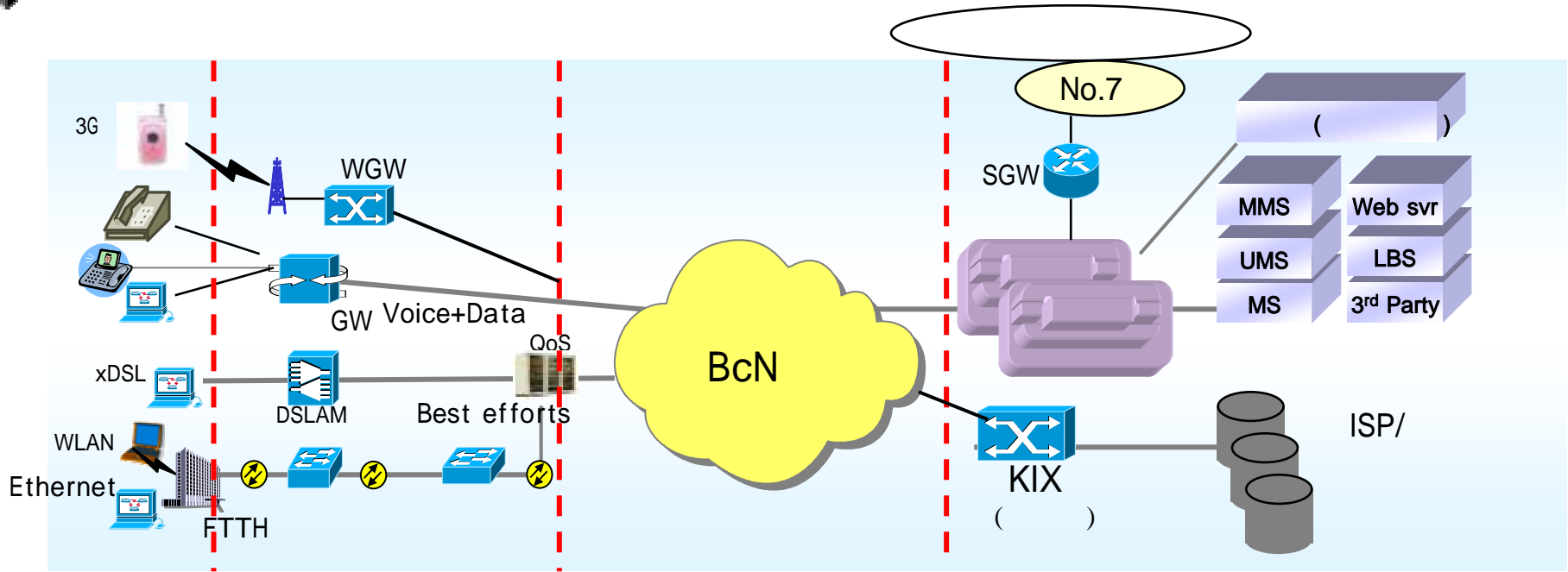

- PSTN TD
  - TD
  - No.7
  - +
  - All IP
- TGW
- Seamless
- FTTH
- +
- KT - BcN

감사합니다.