

# A Passive Multiple Trailer System with Off-axle Hitching

Jae-Hyoung Lee, Woojin Chung, Munsang Kim, and Jae-Bok Song\*

**Abstract:** This paper deals with the design and control of passive multiple trailer systems for practical applications. Due to the cost and complexity of the trailer mechanism, passive systems are preferred to active systems in this research. The design and control objective is to minimize the trajectory tracking errors occurring in passive multiple trailers. Three sorts of passive trailer systems, off-hooked, direct-hooked, and three-point, are discussed in this paper. Trajectory tracking performance and stability issues under constant curvature reference trajectories are investigated for these three types. As well, various simulations and experiments have been performed for each type. It is shown that the proposed off-hooked trailer system produces a tracking performance that is superior to the others.

**Keywords:** Link parameter, off-hooked trailer, passive trailer, trajectory tracking.

## 1. INTRODUCTION

Passive multiple trailer systems consist of a wheeled mobile robot out in front that tows multiple trailers. In the case of passive trailer systems, both the driving and steering are conducted passively by other systems. Passive trailers increase load transportation capacity because of their low cost of fabrication and operation. Furthermore, passive trailers provide reconfigurability and expandability for various applications.

Trailer systems in the past have been studied from the viewpoint of control and analysis of nonholonomic mechanical systems. Laumond [1] dealt with the controllability of a multiple trailer system. Murray proposed the chained form in [2], which provided a way to develop several controllers to steer and stabilize nonholonomic mechanical systems, including the multiple trailer system. Typical examples are the open-loop strategies proposed by Tilbury in [3] and the closed-loop controller by Sordalen [4]. Since these studies dealt with point steering or stabilization issues, they could not be directly applied to the trajectory following problem of passive trailer systems that consisted of more than one passive trailer.

Trailers with active steering capability were studied by several researchers, including Canudas de Wit [5] and Fukushima [6]. Although the active steering system shows good trajectory tracking performance, the scope of this paper is limited to the passive systems that have the advantages of low cost and simple structure. Passive trailers have been used widely in practice (e.g., airport luggage transportation). Typical examples are the trailers by Yamamiya [7] and Nakamura [8]. Nakamura proposed a so-called three-point trailer with passive steerable trailers, which achieved high trajectory following performance.

This study is aimed at designing and controlling passive multiple trailers that have trajectory tracking errors small enough for practical applications. The reference trajectory implies the trajectory of the towing vehicle. Three kinematic models are examined: an off-hooked trailer, a direct-hooked trailer, and a three-point trailer.

Among the numerous works previously prepared on passive trailer systems, only a few have focused on the off-hooked trailer type (the trailer with off-axle hitching), mainly because its kinematic structure is highly complicated and maintaining control is difficult. Most research on the off-hooked trailer systems have dealt with tracking control rather than point-to-point control. Bolzen [9] and Altafini [10] proposed specific control laws for the off-hooked trailer using a feedback linearization method, but it is difficult to extend this law to high dimensional systems. In this paper, it is shown that the off-hooked trailer system is more advantageous than the other types from a practical point of view.

Section 2 explains the kinematic models and different features of passive trailers. Stability issues for the constant velocity reference trajectory are

Manuscript received March 18, 2004; accepted July 10, 2004. Recommended by Editor Keum-Shik Hong.

Jae-Hyoung Lee and Jae-Bok Song are with the Department of Mechanical Engineering, Korea University, 5 Anam-dong, Sungbuk-gu, Seoul 136-701, Korea (e-mails: {quarky, jbsong}@korea.ac.kr).

Jae-Hyoung Lee, Woojin Chung, and Munsang Kim are with Intelligent Robotics Research Center, Korea Institute of Science and Technology, 39-1 Hawolgok-dong, Sungbuk-gu, Seoul 136-791, Korea (e-mails: {quarky, wjchung, munsang}@kist.re.kr).

\* Corresponding author.

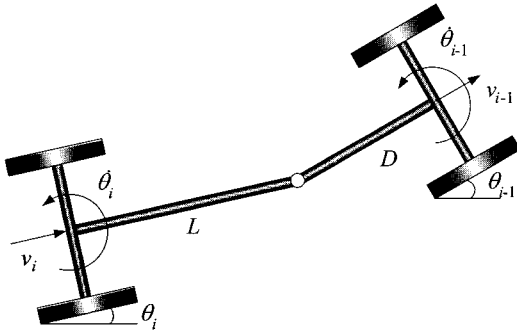

Fig. 1. Off-hooked trailer.

discussed in Section 3 and some simulation results are shown in Section 4. In Section 5, a miniature system of the proposed trailer is fabricated and experimentally tested. Finally, some concluding remarks and future works are presented in Section 6.

## 2. KINEMATICS OF PASSIVE TRAILERS

In this paper, the term ‘vehicle’ is used to represent either the mobile robot or the trailers. For example, a two-vehicle system implies either a robot-trailer or a trailer-trailer system. Furthermore, the kinematics of an arbitrary two-vehicle system are represented by the  $n$  trailer system.

### 2.1. Off-hooked trailer

The off-hooked trailer system shown in Fig. 1 is widely used in practical applications. In the off-hooked trailer system, wheels are not steerable, which makes its mechanical structure simple and leads to low fabrication cost. A major disadvantage of this system is that the kinematic equations are so complicated that the subsequent analysis and controller design are difficult. This paper proposes parameter design and control strategy for the off-hooked trailer system. The kinematic model of trailer  $i$  is expressed by

$$\dot{\theta}_i = \frac{1}{L} \{ \sin(\theta_{i-1} - \theta_i) v_{i-1} - \cos(\theta_{i-1} - \theta_i) \dot{\theta}_{i-1} D \}, \quad (1)$$

$$v_i = \cos(\theta_{i-1} - \theta_i) v_{i-1} + \sin(\theta_{i-1} - \theta_i) \dot{\theta}_{i-1} D, \quad (2)$$

where  $v_i$ ,  $\dot{\theta}_i$ , and  $\theta_i$  are the linear velocity, angular velocity, and angular position of trailer  $i$ , and  $L$  and  $D$  denote the lengths of the front and rear connecting links, respectively. One design problem relates to determining appropriate link parameters  $L$  and  $D$ . The kinematic model in (1) and (2) is so complicated that it cannot be converted into chained form, which is a linearized canonical form of the nonholonomic system [2]. A major difficulty arises from the fact that the angular velocity  $\dot{\theta}_{i-1}$  of the front vehicle appears in

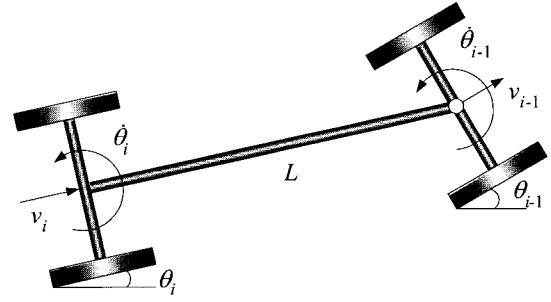

Fig. 2. Direct-hooked trailer.

(1) and (2). In representation of trailer  $i$ , the existence of the angular velocity of trailer  $i-1$  makes it difficult to steer or stabilize the off-hooked trailer to arbitrary configurations.

### 2.2. Direct-hooked trailer

Fig. 2 illustrates a conventional direct-hooked trailer system. It is a special case of the off-hooked trailer in that only the front link exists (i.e.  $D = 0$ ). Note that the trailers are not steerable in the direct-hooked trailer system. The kinematic model of trailer  $i$  can be expressed by

$$\dot{\theta}_i = \frac{1}{L} \sin(\theta_{i-1} - \theta_i) v_{i-1}, \quad (3)$$

$$v_i = \cos(\theta_{i-1} - \theta_i) v_{i-1}. \quad (4)$$

From (3) and (4), it is obvious that the angular velocity  $\dot{\theta}_{i-1}$  of the front vehicle does not affect the motion of the rear trailers. This kinematic model is simple and can be converted into chained form, which enables easy investigation of controllability. However, the direct-hooked trailer system has a mechanical structure that is different from actual trailer systems, and therefore it is difficult to fabricate. Furthermore, convertibility into the chained form does not guarantee good performance of trajectory tracking in practical applications. The trajectories computed in the chained form configuration space are extensively diverse from those in the joint space due to mathematically ill-conditioned mapping [11].

### 2.3. Three-point trailer

A three-point trailer system [8] is illustrated in Fig. 3. The most distinguishing feature of this system is that the wheels are passively steerable using the link mechanism. The wheel steering angle  $\phi_i$  is determined by the positions of two neighboring vehicles (i.e., trailers  $i-1$  and  $i+1$ ). Despite good tracking performance, its mechanical structure is quite complicated, thereby leading to high fabrication cost. Furthermore, the last trailer cannot be properly controlled.

The kinematic model of trailer  $i$  is described by

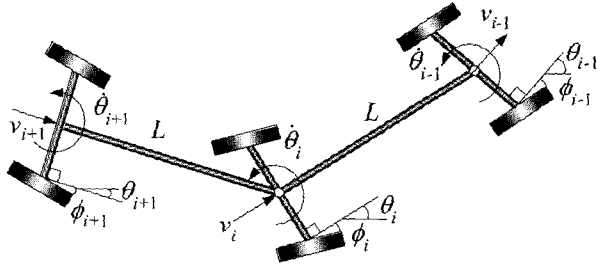

Fig. 3. Three-point trailer.

$$\dot{\theta}_i = \frac{1}{L_i} \{ \sin(\phi_{i-1} - \theta_i) v_{i-1} - \sin(\phi_i - \theta_i) v_i \}, \quad (5)$$

$$v_i = \sec(\phi_i - \theta_i) \cos(\phi_{i-1} - \theta_i) v_{i-1}, \quad (6)$$

$$\phi_i = \mu(\theta_{i+1} - \theta_i), \quad (7)$$

where  $\phi_i$  represents the steering angle and  $\mu$  is the steering gain. The mechanical design to implement the three-point trailer system can be referred to [8].

### 3. STABILITY FOR CONSTANT CURVATURE

#### 3.1. Off-hooked trailers

For simplicity, consider a two-vehicle system. Suppose the front vehicle travels on the reference trajectory with a constant curvature. Then, the following relation is obtained by

$$\frac{v_{i-1}}{\dot{\theta}_{i-1}} = R, \quad (8)$$

where  $R$  is the radius of the front vehicle trajectory. Let the angle difference  $\theta_{i-1} - \theta_i$  be  $\varphi$ . Then (1) can be rewritten as

$$\dot{\varphi} = \left( \frac{D}{L} \cos \varphi - \frac{R}{L} \sin \varphi + 1 \right) \dot{\theta}_{i-1}. \quad (9)$$

It can be easily shown that a stable equilibrium point  $\varphi_0$  exists close to  $\dot{\varphi} = 0$ . Therefore, when the trailer system is in the steady state where the relative angle does not change (i.e.,  $\dot{\varphi} = 0$ ), (9) can be rewritten as

$$D \cos \varphi_0 - R \sin \varphi_0 + L = 0. \quad (10)$$

From (10), the equilibrium point is obtained for the following two cases;

$$\varphi_0 = 2 \tan^{-1} \left( \frac{R \pm \sqrt{R^2 - (L^2 - D^2)}}{L - D} \right), \quad L \neq D. \quad (11)$$

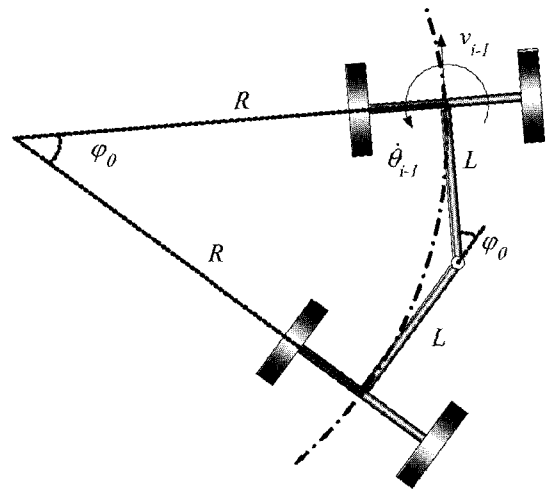

Fig. 4. Stable configuration of the off-hooked trailer system on a circular trajectory.

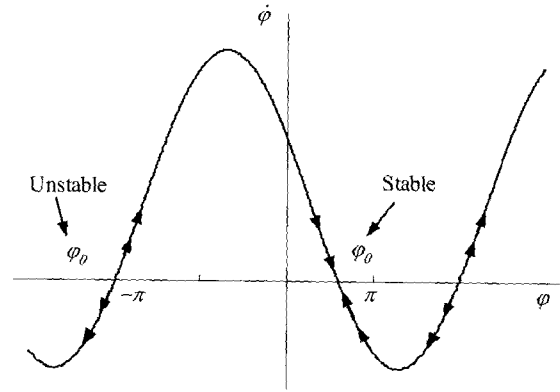

Fig. 5. Phase portrait of off-hooked trailer.

$$\varphi_0 = 2 \tan^{-1} \left( \frac{L}{R} \right), \quad L = D. \quad (12)$$

From (12), if  $L=D$  and  $\varphi=\varphi_0$  as shown in Fig. 4, the rear trailer follows the reference trajectory without error and thus the tracking error converges to zero in the steady state. This implies that the optimization of the link parameters of the off-hooked trailer system is accomplished. Therefore, if the mobile robot travels along the path consisting of lines and circles, no steady state error occurs. Once stability is proved for a two-vehicle system, this proof can be iteratively extended to the multiple trailer system because motion of the passive trailer is affected only by the front vehicle.

The above result can be shown by another approach. From (8),  $\dot{\theta}_{i-1}$  becomes constant for constant  $v_{i-1}$ . Then, the phase portrait of the system illustrated in Fig. 5 can be obtained from (10).

It can be shown that there are stable equilibrium points. An unstable equilibrium point implies that the

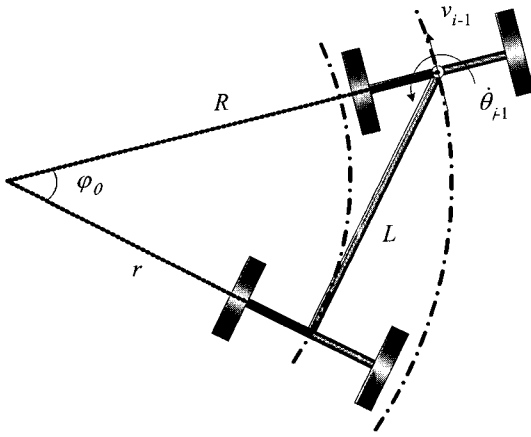

Fig. 6. Stable configuration of direct-hooked trailer system on circular trajectory.

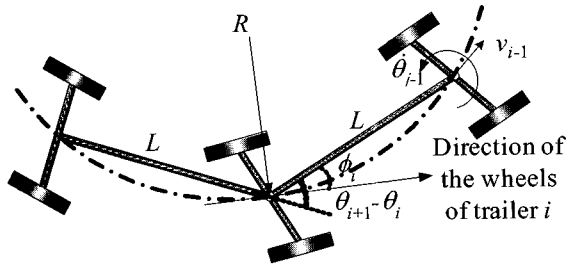

Fig. 7. Stable configuration of three-point trailer system on circular trajectory.

mobile robot “pushes” a trailer. In the off-hooked trailer, there exist transient errors when the curvature of the reference trajectory changes. Therefore, the transient tracking error should be estimated by numerical computations.

### 3.2. Direct-hooked trailer

The direct-hooked trailer system is a special case of the off-hooked trailer system. Therefore, the property of the off-hooked trailer can be applied to the direct-hooked trailer. Under constant curvature, Eq. (3) can be rewritten as

$$\dot{\varphi} = \left( -\frac{R}{L} \sin \varphi + 1 \right) \dot{\theta}_{i-1}. \quad (13)$$

From (13), the equilibrium point of the system can be easily obtained by

$$\varphi_0 = 2 \tan^{-1} \left( \frac{R \pm \sqrt{R^2 - L^2}}{L} \right) = \sin^{-1} \left( \frac{L}{R} \right). \quad (14)$$

Therefore, if the towing vehicle moves without changing the curvature, the trailer’s trajectory converges to a constant curvature. In Fig. 6, which

presents the system at the stable equilibrium point, the trajectory radius of the front trailer is denoted as  $R$  and that of the rear trailer as  $r$ . The stable equilibrium point can also be obtained by

$$\varphi_0 = \tan^{-1} \left( \frac{L}{r} \right). \quad (15)$$

From (14) and (15), if the desired radius of the rear trailer is given, the movement of the front vehicle can be determined. However, if the radius of the reference trajectory is not infinite (i.e., not a straight line), there exists a tracking error  $\varepsilon$  given by

$$\varepsilon = R - r = R - \sqrt{R^2 - L^2}, \quad (16)$$

where  $R > L$ . As the number of trailers increase, the tracking error grows as well. That is the fundamental limitation of a direct-hooked trailer. It is clear that the steady-state tracking error  $\varepsilon$  can be analytically obtained. Therefore, if a mobile robot travels along a path with constant curvature, the required width of collision-free path can be estimated. When the robot travels to different curvature paths, the transient behavior cannot be specified, but the tracking error in (16) is still valid because the transient tracking error is not greater than  $\varepsilon$ , which will become obvious in Section 4.2.

### 3.3. Three-point trailer

The stability analysis of a three-point trailer system is slightly more complicated than the direct-hooked trailer system as shown in Fig. 7. [8] Under the appropriate steering control of the last trailer, the tracking performance is similar to that of the off-hooked trailer system.

## 4. SIMULATION RESULTS

### 4.1. Circular trajectory

Simulation results for the circular reference trajectory are shown in Fig. 8. The trailers are initially on a straight line, and then move to a circle with a radius of 3m. From three cases of  $L < D$ ,  $L = D$ , and  $L > D$  for the off-hooked trailer system, it is easily observed that the optimized link parameter is  $L = D$  since all the trailers track a single trajectory in this case. The computed trajectory matches the trajectory obtained from the stability analysis in Section 3.1. Also it is apparent that the tracking performance of the optimized off-hooked trailer system is much better than that of the other two systems - the direct-hooked trailer and three-point trailer. A significant tracking error occurs for the direct-hooked trailer system in Fig. 8(d). In practice, it is difficult to drive the direct-hooked system consisting of several trailers due to this tracking error. The three-point trailer

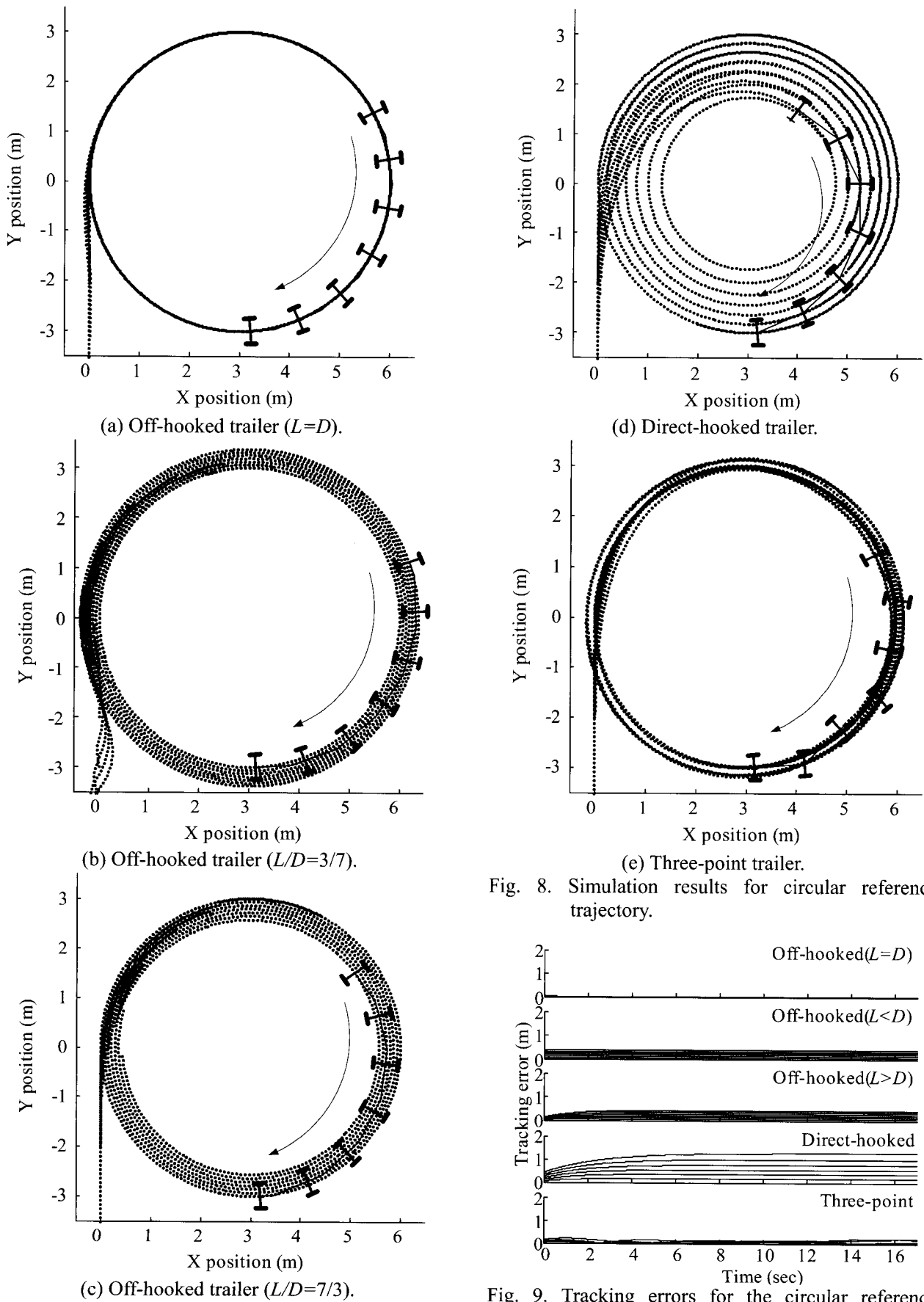

Fig. 8. Simulation results for circular reference trajectory.

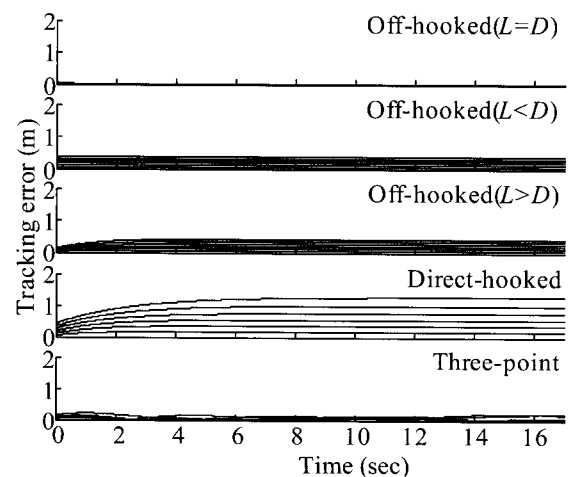
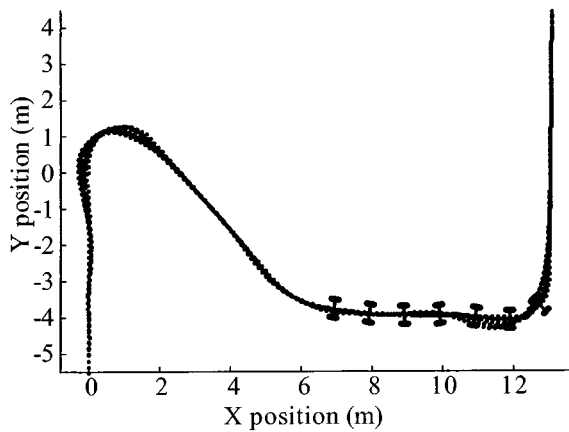
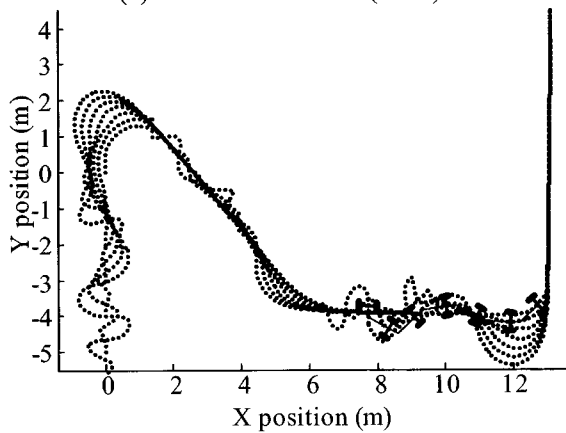
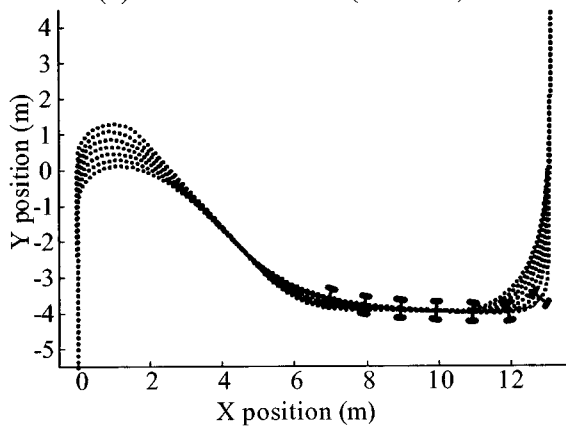
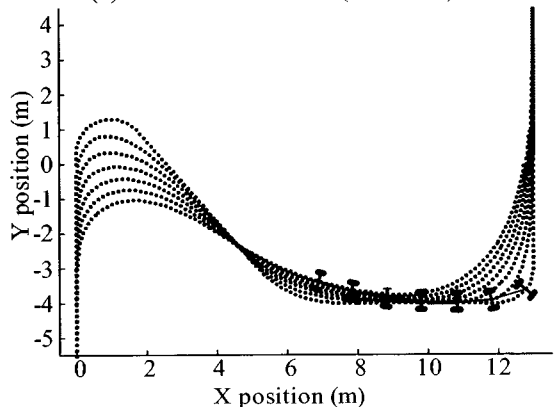
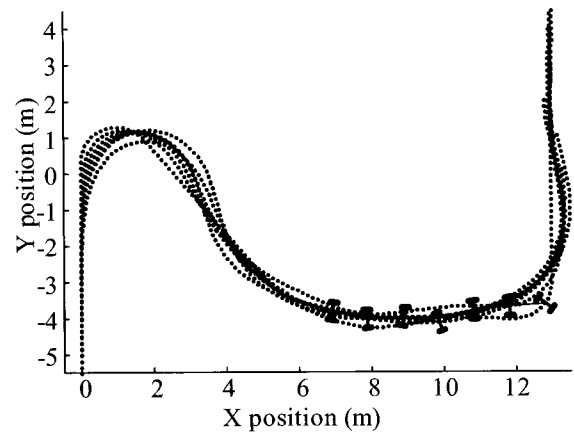

Fig. 9. Tracking errors for the circular reference trajectory.

(a) Off-hooked trailer ( $L=D$ ).(b) Off-hooked trailer ( $L/D=3/7$ ).(c) Off-hooked trailer ( $L/D=7/3$ ).

(d) Direct-hooked trailer.



(e) Three-point trailer.

Fig. 10. Simulation results for linear reference trajectory.

system exhibits smaller tracking errors than the direct-hooked system. However, two different trailer trajectories are observed in the steady state. Since the trailer  $i$ 's steering depends on the positions of trailers  $i-1$  and  $i+1$ , the last trailer without the rear trailer has a different trajectory. Proper control based on the three-point model cannot be conducted for the last trailer, so its tracking error does not converge to zero.

The computed tracking errors along the circular trajectory for five systems are shown in Fig. 9. In the off-hooked trailer with the optimized link parameter (i.e.,  $L=D$ ), the maximum tracking error is 0.08m, which is much smaller than 1.27m in the direct-hooked trailer system and 0.21m in the three-point trailer system.

#### 4.2. Linear reference trajectory

In practical applications, the trailer system may encounter sharp corners or crossings. Fig. 10 depicts the simulation results for the reference trajectory consisting of four straight-line segments. At the corners where the straight lines meet, a curve with a radius of 1m has been blended with straight lines for a continuous trajectory.

The simulation results for the linear reference trajectory indicate that  $L=D$  is the optimized link parameter. In the case of  $L<D$ , the simulation result may not occur in practice since the driving force of the actual robot is limited. Furthermore, in the case of  $L>D$ , the resulting trajectory is similar to that of the direct-hooked trailer since the direct trailer is the extreme case of the off-hooked trailer with  $L>D$ .

From the simulation results in Fig. 10, it is shown that the proposed off-hooked trailer system with  $L=D$  provides superior performance than the other four systems. For the direct-hooked trailer system, the maximum error occurs at the last trailer in most cases. Therefore, the number of trailers is limited by the allowable width of a collision-free path.

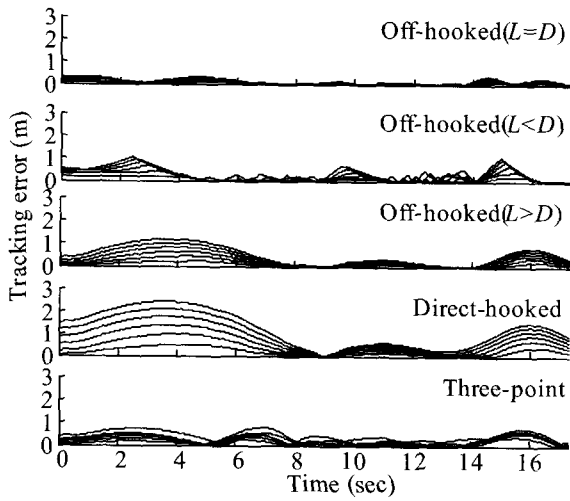

Fig. 11. Tracking errors for the linear reference trajectory.

The width of the collision-free path of the trailer system can be estimated by numerical computation. For the proposed off-hooked trailer system in Fig. 10(a), the required width of the collision-free path for 90° turning is 1.2m, which is considerably smaller than 5.3m for the direct-hooked trailer system or 2.1m for the three-point trailer system. Fig. 11 shows comparison of the computed tracking errors along the linear reference trajectory. The maximum tracking errors are 2.41m for the direct-hooked trailer, 0.72m for the three-point trailer system, and 0.32m for the proposed off-hooked trailer system. Even for the proposed off-hooked trailer system, there is a slight tracking error, due to a change in the curvature. However, tracking errors of the proposed off-hooked trailer are much less significant than that of other trailers.

It is observed that the trailer configuration of the proposed off-hooked trailer becomes zigzag when the radius of curvature of the reference trajectory is smaller than half of the link length. However, this chance can be avoided by careful design of kinematic parameters or appropriate path planning.

### 5. EXPERIMENTS

#### 5.1. Description of a trailer system

To demonstrate advantages of the proposed off-hooked trailer system over other systems, small-scaled prototypes were built. The experimental setup was composed of a mobile robot and trailers, a host PC (PII 500MHz), a vision system (Samsung CCD camera, Matrox meteor-II), and wireless serial communication (Radiometrix RF module). The trailer systems have been devised by utilizing the commercialized soccer robot system [12]. Physical dimensions of the mobile robot and the trailer are 75x75x70mm and 75x70x35mm, respectively.

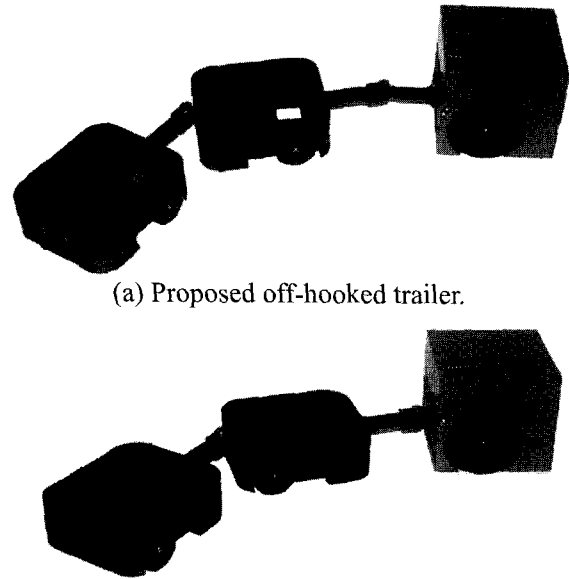

(a) Proposed off-hooked trailer.

(b) Semi-direct-hooked trailer.

Fig. 12. Two trailers systems used in experiments.

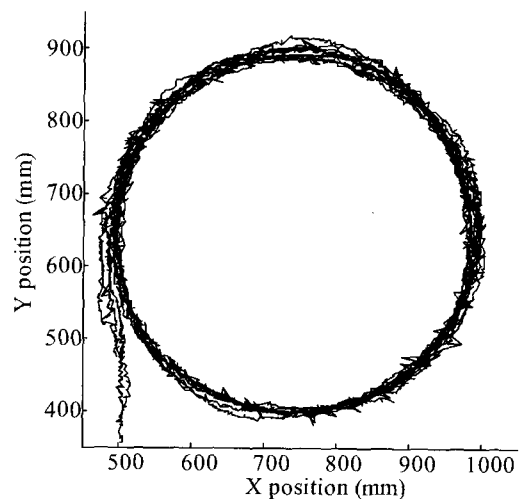

(a) Off-hooked trailer.

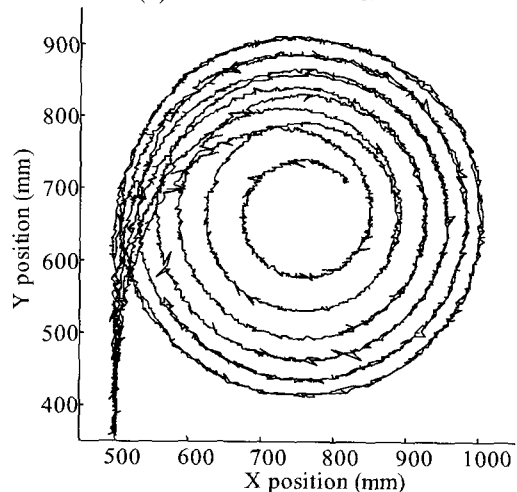

(b) Semi-direct-hooked trailer.

Fig. 13. Experimental results for circular reference trajectory.

Two trailer systems were built for purposes of experimentation. The first trailer system is the proposed off-hooked trailer system with  $L=D=65\text{mm}$ . The second trailer system is also the off-hooked type with  $L=115\text{mm}$  and  $D=15\text{mm}$ , but this system exhibits motion similar to the direct-hooked system, so it will be referred to as the semi-direct-hooked trailer from this point.

### 5.2. Circular reference trajectory

In the experiment, trajectories with constant curvature were used so that the linear and angular velocities of each mobile robot remained constant. The linear and angular velocity used in the experiment is an unusual case in that the mobile robot travels along the circular reference trajectory. Fig. 13 shows experimental results obtained by a color vision system. The trajectories of the semi-direct-hooked trailer system converged to several circles with different radii. Trailer  $i+1$  followed a circle whose radius was smaller than the trajectory of trailer  $i$ . In the optimized off-hooked trailer system, however, each trailer followed the circular trajectory with the identical radius. The experimental results in Fig. 13 showed good agreement with the simulation results in Fig. 8. The maximum tracking error of 15mm in the

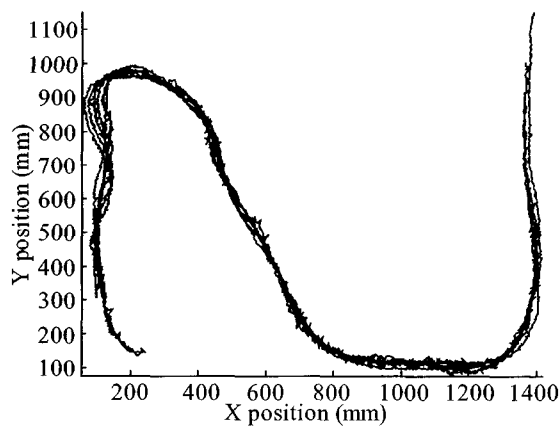

(a) Off-hooked trailer.

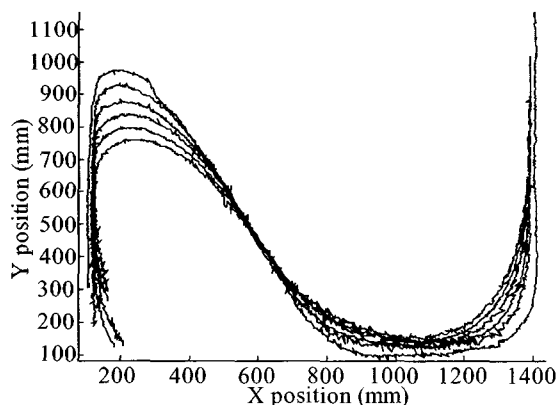

(b) Semi-direct-hooked trailer.

Fig.14. Experimental results for linear reference trajectory.

proposed off-hooked trailer system was much smaller than 150mm in the semi direct-hooked trailer system. It is clear, therefore, that the proposed off-hooked trailer system demonstrates better performance than the others.

### 5.3. Linear reference trajectory

Fig. 14 shows the experimental results for tracking the linear reference trajectories that are frequently encountered during practical applications. The radius of reference trajectory at each corner where two straight lines meet was 100mm. The mobile robot started from the point (100, 300) and stopped at the point (1400, 1200). The experimental results are similar to the simulation results shown in Fig. 10. The maximum tracking error of 67mm in the proposed off-hooked trailer system was much smaller than 274mm in the semi-direct-hooked trailer system. Therefore, the proposed off-hooked trailer system performs better than the others.

## 6. CONCLUSIONS

In this research the mechanical structures and kinematic models of three trailer systems have been compared in detail. Although the kinematic equation of the off-hooked trailer system is rather complicated, the mechanical structure is simpler and the steady-state tracking error is much smaller than in the other two systems. From various simulation and experimental results, the following conclusions have been drawn:

- 1) The proposed off-hooked trailer system shows better tracking performance in tracking both the circular and linear trajectories than the direct-hooked trailer system and the three-point trailer system.
- 2) The required width of a path of the proposed off-hooked trailer system is about 1/5 and 1/2 that of the direct-hooked trailer and the three-point trailer in the simulation, respectively. Therefore, the proposed off-hooked trailer system is able to travel in the narrower path than the other trailer systems.
- 3) The stability analysis and numerical simulations presented in this paper can serve as a basis for path planning capable of collision avoidance for the passive multiple trailer systems.

In the future, a series of experiments based on the actual off-hooked trailer system will be conducted and research on its motion planning and control are also to be carried out.

## REFERENCES

- [1] J. P. Laumond, "Controllability of multibody mobile robot," *IEEE Trans. on Robotics and Automation*, vol. 9, no. 6, pp. 755-763, 1993.



- [2] R. M. Murray and S. S. Sastry, "Nonholonomic motion planning: steering using sinusoids," *IEEE Trans. on Automatic Control*, vol. 38, no. 5, pp. 700-716, 1993.
- [3] D. M. Tilbury, R. M. Murray, and S. S. Sastry, "Trajectory generation for  $n$ -trailer problem using goursat normal form," *Proc. of the IEEE control and Decision conference*, pp. 971-977, 1993.
- [4] O. J. Sordalen and K. Y. Wichlund, "Exponential stabilization of a car with  $n$  trailers," *Proc. of 32nd conference on Decision and Control*, San Antonio, pp. 978-983, 1993.
- [5] C. Canudas de Wit, A. D. Ndoudi-Likoho, and A. Micaelli, "Nonlinear control for a train-like vehicle," *International Journal of Robotics Research*, vol. 16, no. 3, pp. 300-319, 1997.
- [6] E. F. Fukushima, S. Hirose, and T. Hayashi, "Basic considerations for the articulated body mobile robot," *IROS*, pp. 386-393, 1998.
- [7] K. Yamamiya, "Yamamia's trailer," *Japanese patent official report B62D13-00* (In Japanese), H2-189285, 1990.
- [8] Y. Nakamura, H. Ezaki, and W. Chung, "Design of steering mechanism and control of nonholonomic trailer systems," *Journal of Robotics Society of Japan* (In Japanese), pp. 839-847, 1999.
- [9] P. Bolzern, R. M. Desantis, A. Locatelli, and D. Masciocchi, "Path-tracking for articulated vehicles with off-axle hitching," *IEEE Trans. on Control Systems Technology*, vol. 6, no. 4, pp. 515-523, 1993.
- [10] C. Altafini, "A path-tracking criterion for an LHD articulated vehicle," *International Journal of Robotics Research*, vol. 18, no. 5, pp. 435-441, 1999.
- [11] W. Chung and Y. Nakamura. "Design of the chained form manipulator," *Proc. of IEEE International Conference on Robotics and Automation*, pp. 455-461, April 1997.
- [12] J. W. Kim, *Robot Soccer System* (In Korean), 1st edition, Daeyoungsa, 2000.



**Jae-Hyoung Lee** received his B.S. degree in Physics and his M.S. degree in Mechanical Engineering from Sogang University, Korea, in 1997 and 1999, respectively. Presently, he is a Doctorial Fellow in mechanical engineering for Korea University and KIST (Korea Institute of Science and Technology). His current research interests are design and control of trailer systems, design and control of robotic systems including bilateral teleoperators and haptic devices.

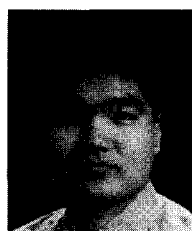

**Woojin Chung** received his B.S. from the Department of Mechanical Design and Production Engineering, Seoul National University in 1993. He received his M.S. degree in 1995 and Ph.D. degree in 1998, both from the Department of Mechano-Informatics, the University of Tokyo. He received an excellent paper award from the Robotics Society of Japan in 1996 and the King-sun Fu Memorial Best Transactions Paper Award from the IEEE Robotics and Automation Society in 2002. Currently, he is a Senior Research Scientist at the Advanced Robotics Research Center, KIST in Korea. His research interests include the design and control of nonholonomic underactuated mechanical systems, control architecture design of autonomous robots, trailer system design and control, mobile robot navigation, and a dexterous robot hand.



**Munsang Kim** received his B.S. and M.S. degrees in Mechanical Engineering from Seoul National University in 1980 and 1982, respectively and his Dr.-Ing. degree in Robotics from the Technical University of Berlin, Germany in 1987. Since 1987 he has been working as a Research Scientist at KIST. He has led the Advanced Robotics Research Center since 2000 and became Director of their "Intelligent Robot - The Frontier 21 Program" as of Oct. 2003. His current research interests are design and control of novel mobile manipulation systems, haptic device design and control, and sensor application to intelligent robots.

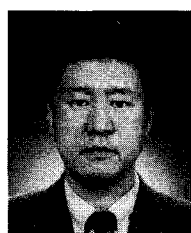

**Jae-Bok Song** received his B.S. and M.S. degrees in Mechanical Engineering from Seoul National University, Korea, in 1983 and 1985, respectively, and his Ph.D. degree in Mechanical Engineering from MIT in 1992. He joined the faculty of the Department of Mechanical Engineering, Korea University in 1993, where he has been a Full Professor since 2002. His current research interests are robot navigation, and design and control of robotic systems including haptic devices.