

Relation between Pressure Variations and Noise in Axial Type Oil Piston Pumps

Jong-Ki Kim*, **Hyoung-Eui Kim**

*Korea Institute of Machinery & Materials,
171 Jang-dong, Yuseong-Gu, Daejeon 305-600, Korea*

Jae-Youn Jung

*Faculty of Mechanical & Aerospace System Engineering, Chonbuk National University,
Jeonju, Jeonbuk 561-756, Korea*

Seok-Hyung Oh

*Faculty of mechanical Engineering, Kunsan National University,
Kunsan, Jeonbuk 573-701, Korea*

Seok-Hoon Jung

Department of Automobile, Byuksung College, Kimje, Jeonbuk 576-711, Korea

Pressure variation is one of the major sources on noise emission in the axial type oil piston pumps. Therefore, it is necessary that the pressure variation characteristics of the oil hydraulic piston pumps be clarified to reduce the pump noise. Pressure variations in a cylinder at the discharge region and the pump noise were simultaneously measured with discharge pressures and rotational speeds during the pump working. To investigate the effects of the pre-compression and the V-notch in the valve plate, we used the three types of valve plates. In this research, it is clear that the pressure variation characteristics of axial type oil piston pumps is deeply related to the pre-compression and to the V-notch design in valve plate. Therefore, we could reduce the pump noise by using the appropriate pre-compression angle and the notch design that are between the suction port and the discharge port in valve plate.

Key Words : Pressure Variation, Noise, Piston Pump, Valve Plate

1. Introduction

The use of axial piston pumps is rapidly increasing due to its high overall efficiency that makes machines operate at greater rotational speeds and at greater discharge pressures. At the same time, much studies have been carried out to improve the pump design (Jung and Kim, 2003). Useful design techniques have been im-

proved and used for a number of years. Recently, working pressures and speeds have risen, so that noise emission has become relatively greater while the mass of individual units has tended to fall. Therefore, more concern has been shown over environmental conditions, so that the noise problem in hydraulic system must be solved. It is a first step towards identifying the sources of noise to solve the noise problem. Theoretical investigations of noise emission was carried out by Helgestad et al. (Helgestad et al., 1974 ; Lin et al., 1985). However, few experimental evidences have been published as verification of the theoretical investigations (Edge and Darling, 1986 ; Hiroshi et al., 1998). One of the major noise sources in an axial piston pump is the pressure variation characteristics in the cylinder and the

* Corresponding Author,

E-mail : bellflag@kimm.re.kr

TEL : +82-42-868-7163; FAX : +82-42-868-7186

Korea Institute of Machinery & Materials, 171 Jang-dong, Yuseong-Gu, Daejeon 305-600, Korea. (Manuscript Received September 23, 2003; Revised February 27, 2004)

discharge line. But, it is very difficult to obtain the pressure variations from cylinder port, because the cylinder block is rotating at high speed. So far, a few reliable experimental examination of the pressure variations in the cylinder of axial type oil piston pump has been published. In this research, the exact pressure variations were measured in the cylinder by using a high performance pressure transducer and a slip ring unit in working conditions. Therefore, we tried to clarify the relations between pressure variations and pump noise and to obtain the solution of the noise in axial type oil piston pumps.

2. Experimental Apparatus

2.1 Test piston pump

The picture of the test cylinder block is shown in Fig. 1. The specifications of the test piston pump is shown in Table 1. The miniature pressure transducer was mounted in a hole around the cylinder to continuously measure the pressure variations during the working period of the test pump. The specifications of the miniature pressure transducer is shown in Table 2. A wire of the pressure transducer was led through the center of the shaft and taken out from rear housing to connect with the slip ring unit. During

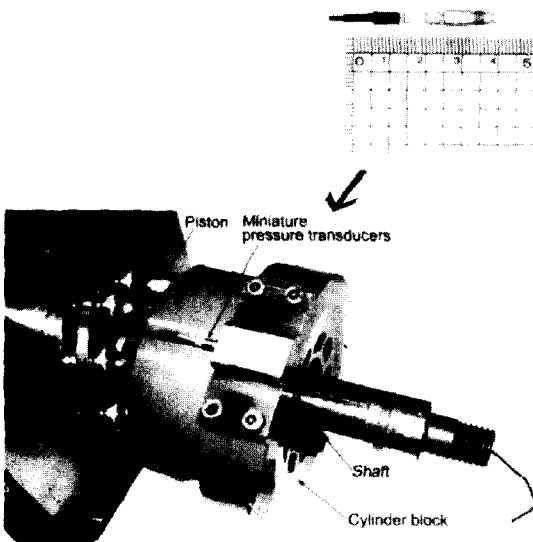

Fig. 1 Picture of test cylinder block

the rotation of the cylinder block, signals from the pressure transducer are transmitted to a recorder via a mercury-cell slip ring unit. A digital oscillographic recorder was used in order to display the pressure transducer signals which were permanently stored in the recorder's memory and plotted by some other graphic programs in a personal computer.

2.2 Test specimen

A section diagram of the test piston pump is shown in Fig. 2. The shapes of the test valve

Table 1 Specifications of test piston pump

Displacement (cc/rev)	63
Swash plate angle (deg)	18
The number of piston	9
Max. pressure (MPa)	35
Max. speed (rpm)	2000

Table 2 Specifications of miniature pressure transducer

Dynamic Range (MPa)	34.5
Max. Pressure (MPa)	51.7
Resolution (kPa)	0.69
Linearity (% FS)	≤2.0
Maker (Sensor type)	PCB Piezotronics (Piezo)

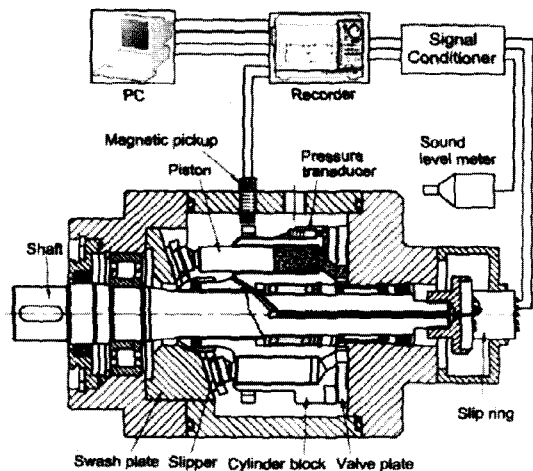

Fig. 2 Schematic diagram of test piston pump

plates are shown in Fig. 3. Three valve plates are used in the test. One is the valve plate without pre-compression angle and V-notch. Another is the valve plate with only pre-compression angle and the other is the valve plate with pre-compression angle and V-notch.

2.3 Hydraulic circuit of the test

The arrangement of the hydraulic circuit for the experiment is shown in Fig. 4. The test piston pump is driven by a variable speed electric motor (75 KW). The motor speed is continu-

ously adjusted from 0 to 2,000 rpm by using a vector inverter controller. The test piston pump is connected with a driving motor by insulating coupling. The torque sensor is mounted in the middle between the test pump and the driving motor.

The pressure, flow and temperature sensors are mounted in the discharge line. The relief valve controls the discharge pressure ranged from 0 to 35 MPa in the test pump. The heat exchanger was used to control the oil temperature in test unit. Furthermore, the filter was mounted in the return line so as to maintain the cleanness of the working oil.

2.4 Principle of pressure variation and test conditions

As the cylinder rotates, pistons execute a stroke that depends on the swivel angle. During a revolution, each cylinder experiences a square wave as a form of pressure. Undesirable events may occur when successive cylinders are near the top dead center (TDC) and the bottom dead center (BDC). As the cylinder approaches to BDC, the piston moves outwards. If the suction port closes off too soon, a low pressure will be created in the cylinder, whereas, if it is open until after BDC, the working oil will be forced back into the suction port as the piston moves inward. As the cylinder passes to BDC, the working oil in the cylinder will begin to be compressed. If the discharge port opens too soon, the cylinder, initially containing low-pressure oil, is suddenly exposed to the high pressure discharge port. Thus, a transient reverse flow occurs inward the cylinder through the discharge port until the cylinder contents are rapidly compressed to the high pressure appropriately. On the other hand, if the discharge port opens too late, the oil in the cylinder is compressed to the extremely high level and a large pressure overshoot would occur.

Therefore, in this research, these pressure variations in the cylinder will be exactly measured. The main test conditions which were considered are the discharge pressure, the rotational speed and the valve plate design. From this research what

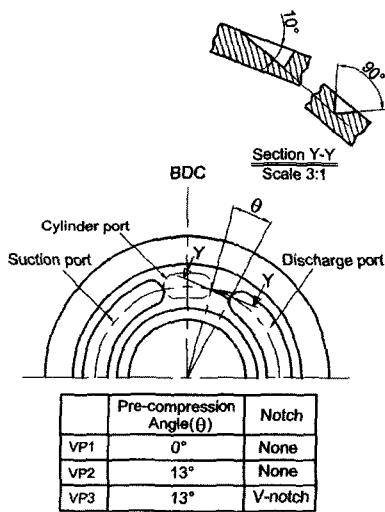

Fig. 3 Shape of test valve plates

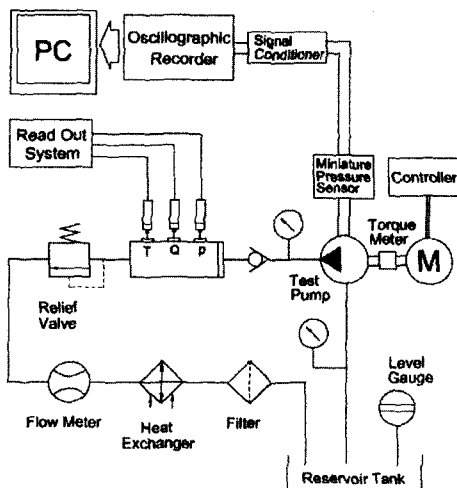

Fig. 4 Hydraulic circuit for test equipment

we have acquired as test results are the pressure variations in the cylinder, the discharge pressure pulsations in the discharge line and the pump noise. The range of discharge pressure is 0–35 MPa and the range of rotational speed is 0–1800 rpm. The working oil is VG46 and the oil temperature is controlled to maintain $40 \pm 2^\circ\text{C}$.

3. Results and Discussion

3.1 Effects of discharge pressure

Figure 5 shows the pressure variations in one cylinder of VP1 with the discharge pressure at 1500 rpm during one revolution of the cylinder block. It was found that small pressure fluctuations have appeared in the discharge range due to continuous change in the number of pistons. As the discharge pressure increases, the fluctuation width of the pressure in cylinder also increases and more abrupt pressure may increase in the cylinder. If the discharge pressure increases, the cylinder, initially containing low-pressure oil, is suddenly exposed to the high-pressure discharge port. A transient reverse flow thus occurs inward through the port until the cylinder contents are rapidly compressed to the discharge pressure. Therefore, the pressure variations in the cylinder are largely increased as the discharge pressure increases.

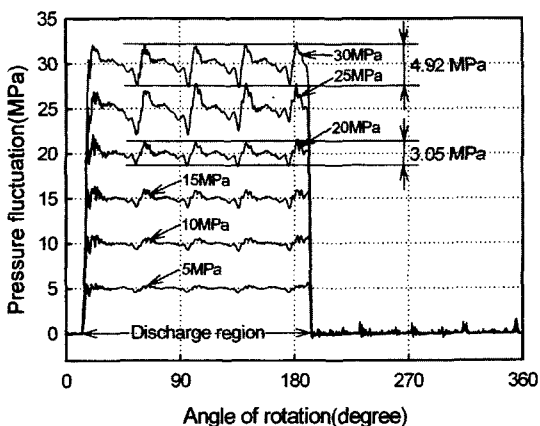

Fig. 5 Pressure variations in cylinder at 1500 rpm (VP1)

3.2 Effects of pre-compression angle

If we design the pre-compression angle in the valve plate, the pressure in the cylinder will rise during passing this region from BDC. Therefore, the pressure variations in the cylinder can be remarkably reduced if the cylinder is connected to the discharge port when the pressure in the cylinder becomes equal to the discharge pressure due to the pressure rising at the pre-compression angle.

Figure 6 shows the pressure variations in one cylinder of VP2 with the discharge pressure at 1500 rpm during one revolution of the cylinder block. The discharge pressure is changed 5 MPa at a time from 5 MPa to 30 MPa. On the whole ranges, it was found that the pressure variations of VP2 considerably have reduced comparing with the pressure variations of VP1. In case of VP1, the pressure variation width is 4.92 MPa at 30 MPa. But, in case of VP2, the pressure variation width is 3.41 MPa at 30 MPa. Therefore, the pressure variation width of VP2 is reduced by at least 30% comparing with the VP1.

3.3 Effects of V-notch

Figure 7 shows the pressure variations in one cylinder of VP3 with discharge pressure at 1500 rpm during one revolution of the cylinder block. The VP3 has both the V-notch and the pre-compression angle in the valve plate. We can see that the pressure variations are remarkably

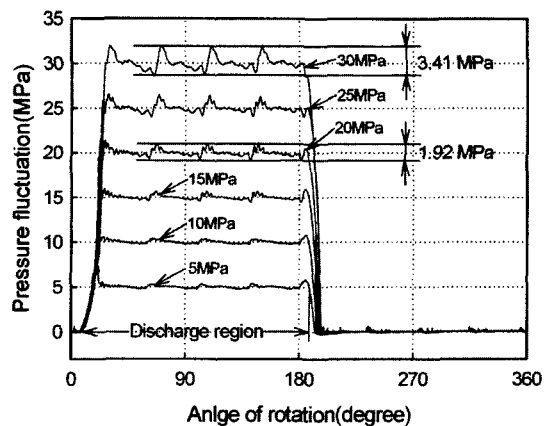

Fig. 6 Pressure variations in cylinder at 1500 rpm (VP2)

reduced comparing to the VP1 and the minute vibrations of pressure disappear over the discharge pressure ranges. We can say that the reverse flow through the V-notch have affected the result. The fluid within the cylinder is compressed by the reverse flow passing from the discharge port through the V-notch into the cylinder. The fluid in V-notch is initially accelerated into the cylinder and then is decelerated as the level of reverse flow reduces. Therefore, the cylinder pressure continues to rise and eventually reaches the discharge port.

Figure 8 shows the pressure rising slope in the cylinder at 30 MPa discharge pressure. The time in Fig. 8 is the value that the pressure

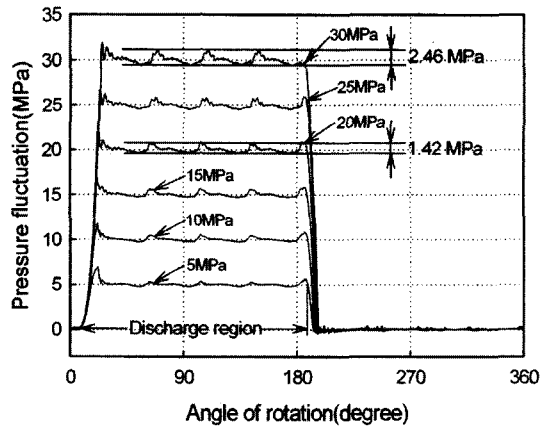

Fig. 7 Pressure variations in cylinder at 1500 rpm (VP3)

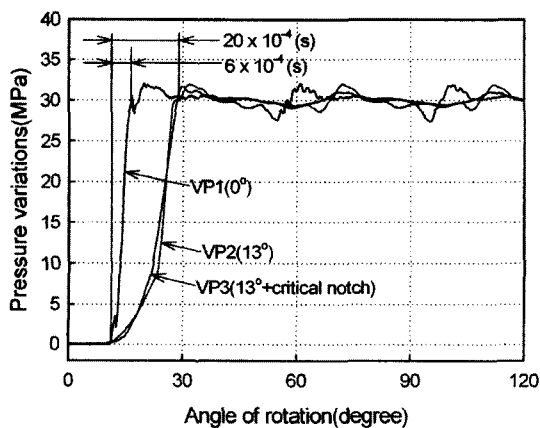

Fig. 8 Comparison of pressure rising slopes at BDC

rising slope be converted to time. In case of VP1, the rising time from suction pressure to discharge pressure is (sec.). But, in case of VP3, the rising time from the suction pressure to the discharge pressure is (sec.). Therefore, we can say that the rising time of pressure gets longer by the design of the V-notch and the pre-compression angle in valve plate and the pressure variations also largely reduced throughout the discharge pressure ranges.

3.4 Effects of rotational speed

Figure 9 shows the comparison of the pressure variations in cylinder of VP3 with the rotational speed at 20 MPa. Due to the increase of rotational speed, the pressure overshoot at the initial stage of pressure rising increases and the pressure variation in cylinder largely increases at the discharge range. But, the increasing rates of the pressure variations are not proportioned to the increase of the rotational speed. In other words, the width of pressure variations slightly increases by increasing the rotational speed from 500 rpm to 1000 rpm but the width of pressure variations abruptly increases by increasing the rotational speed from 1000 rpm to 1500 rpm. These phenomena would occur because the size of the discharge line and control valve are fixed in the hydraulic system. Therefore, the discharge line and the control valve will experience more and

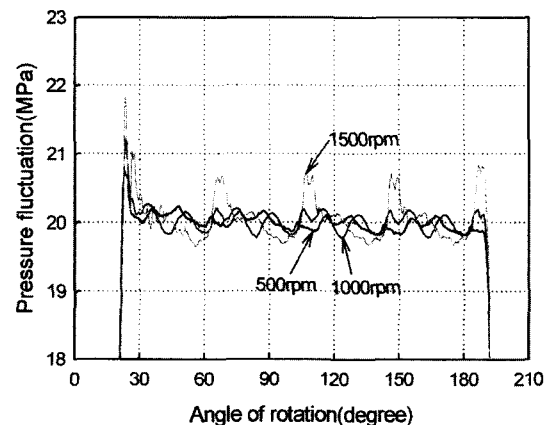

Fig. 9 Comparison of pressure variations in cylinder with rotational speed at 20 MPa

more resistance as the discharge flow rates increase and they would lead to the increases of the pressure variations in cylinder. As the rotational speed increases, the V-notch loss becomes more significant and the reverse flow will increase. If the reverse flow increases, the fluid in V-notch will be accelerated at a higher rate and the pressure overshoot at BDC will increase. Therefore, the pump noise also increases as the pressure overshoot in the cylinder port increases with the rotational speed.

3.5 Comparison of pressure pulsations

Figure 10-Fig. 12 shows the pressure pulsations in discharge line with the discharge pressure at 1500 rpm during two revolutions of the cylinder block.

The nine pressure pulsations produce during one revolution of the cylinder block, because the test piston pump has nine pistons. As the discharge pressure increases, the pressure pulsations also increases due to the increase of the pressure variations in cylinder. It is found that the pressure pulsations are getting better from VP1 to VP3 on the whole ranges.

Figure 13 shows the comparison of the pressure pulsations among three test valve plates at 30 MPa. The pressure pulsations of the VP3 are the most stable when comparing with the rest of two valve plates. The value of VP3 with pre-compression angle and the V-notch is about 65% of the VP1's value. Therefore, the pressure

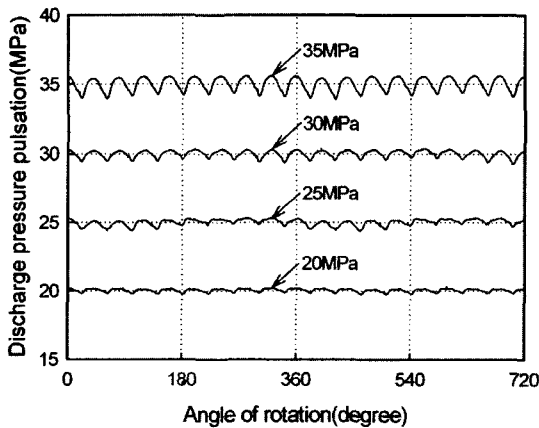

Fig. 10 Pressure pulsations in discharge line (VP1)

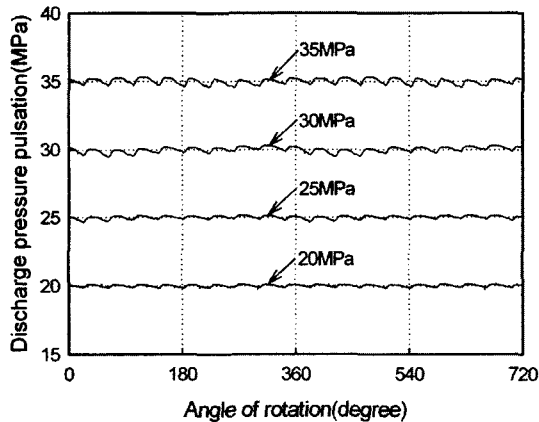

Fig. 11 Pressure pulsations in discharge line (VP2)

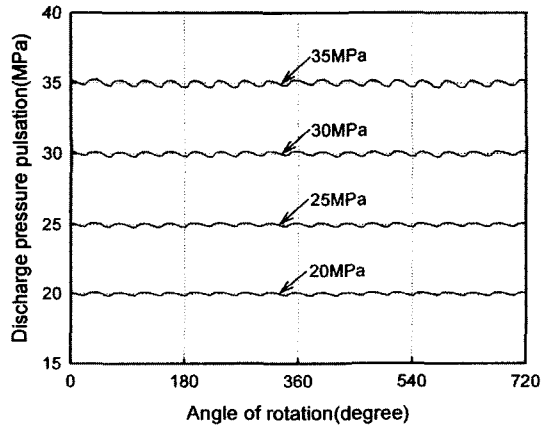

Fig. 12 Pressure pulsations in discharge line (VP3)

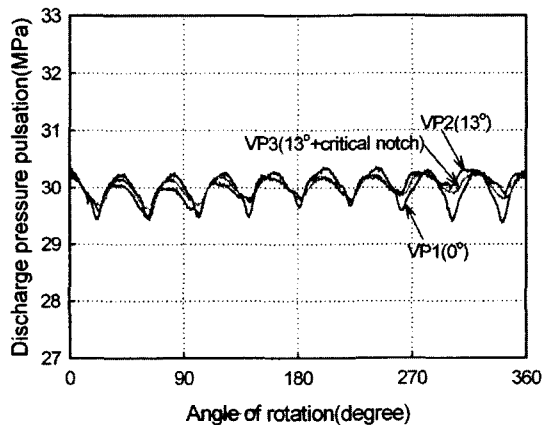

Fig. 13 Comparison of pressure pulsations in discharge line

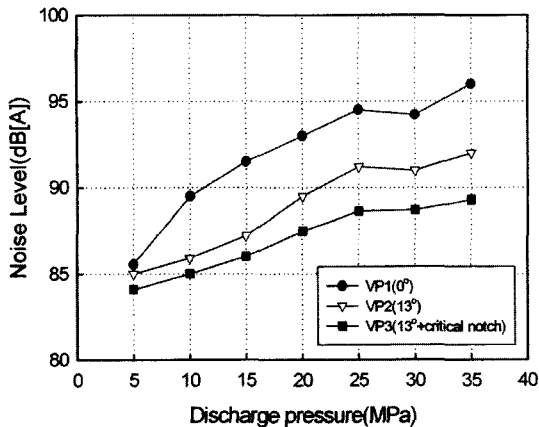

Fig. 14 Comparison of pump noise

pulsations in discharge line can be reduced up to 35% by the design of the pre-compression angle and the V-notch at the valve plate.

3.6 Comparison of pump noise

Figure 14 shows the comparison of the pump noise level with the discharge pressure at 1500 rpm. On the whole ranges, it is found that the noise level of VP3 is the smallest and the noise level of VP1 is the largest. At from 15 to 35 MPa of discharge pressure ranges, the noise level of VP3 is reduced up to 7 dB[A] comparing with the VP1. It is clear that the pump noise is deeply related with the pressure variations in cylinder and the pressure pulsations in discharge line. Therefore, the pressure variations in cylinder and the pressure pulsations in discharge line must be minimized in order to reduce the pump noise. The design of the pre-compression angle and the V-notch in the valve plate is one of the solutions to reduce the pressure variations and the pressure pulsations.

4. Conclusions

To clarify the relations between the pressure variations and the pump noise, the pressure variations in cylinder and the pressure pulsations in discharge line, the pump noise were measured

with discharge pressure, rotational speed and three types of valve plates in oil hydraulic piston pumps. Therefore, the following results were obtained :

(1) The pressure variations in cylinder increase as the discharge pressure and the rotational speed increase.

(2) The pump noise is deeply related with the pressure variations in cylinder and the pressure pulsations in discharge line.

(3) The pressure variations in cylinder and the pressure pulsations in discharge line can be reduced by designing the pre-compression angle and the V-notch in the valve plate, which consequently result in the reduction of the pump noise.

References

- Edge, K. A. and Darling, J., 1986, "Cylinder Pressure Transients in Oil Hydraulic Pumps with Sliding Plate Valves," *Proc. Inst. of Mech. Engrs.*, Vol. 200, pp. 45~54.
- Helgestad, B. O., Fosser, K. and Bannister, F. K., 1974, "Pressure Transients in an Axial Piston Hydraulic Pump," *Proc. Inst. of Mech. Engrs.*, Vol. 188, No. 17, pp. 198~199.
- Hiroshi KOSODO et al., 1998, "Experimental Research on Pressure-Flow Characteristics of the V-notch," *Fluid power system*, Vol. 29, No. 1, pp. 16~22.
- Jung J. Y. and Kim, J. K., 2003, "Driving Mechanism of Tapered Pistons in Bent-Axis Design Axial Piston Pumps," *KSME International Journal*, Vol. 17, No. 2, pp. 181~186.
- Jung, J. Y. and Kim, J. K., 2003, "Measurement of Fluid Film Thickness on the Valve Plate in Oil Hydraulic Axial Piston Pumps (Part 1: bearing pad effects)," *KSME International Journal*, Vol. 17, No. 2, pp. 246~253.
- Lin, S. J., Akers, A. and Zeiger, G., 1985, "The Effect of Oil Entrapment in an Axial Piston Pump," *Transactions of the ASME*, Vol. 107, pp. 246~251.