

# $H_\infty$ Control System for Tandem Cold Mills with Roll Eccentricity

**Seung-Soo Kim\***

*Research Center for Machine Part and Materials Processing, University of Ulsan,  
29 Muger2-dong, Nam-gu 680-749, Korea*

**Jong-Shik Kim**

*School of Intelligent and Mechanical Engineering, Pusan National University,  
Gumjung-gu, Busan 609-735, Korea*

**Soon-Yong Yang, Byung-Ryong Lee, Kyung-Kwan Ahn**

*School of Mechanical-Automotive Engineering, University of Ulsan,  
29 Muger2-dong, Nam-gu 680-749, Korea*

In order to meet the requirement for higher thickness accuracy in cold rolling processes, it is strongly desired to have high performance in control units. To meet this requirement, we have considered an output regulating control system with a roll-eccentricity estimator for each rolling stand of tandem cold mills. Considering entry thickness variation as well as roll eccentricity as the major disturbances, a synthesis of multivariable control systems is presented based on  $H_\infty$  control theory, which can reflect the knowledge of input direction and spectrum of disturbance signals on the design. Then, to reject roll eccentricity effectively, a weight function having some poles on the imaginary axis is introduced. This leads to a non-standard  $H_\infty$  control problem, and the design procedures for solving this problem are analytically presented. The effectiveness of the proposed control method is evaluated through computer simulations and compared to that of the conventional LQ control and feedforward control methods for roll eccentricity.

**Key Words :** Non-Standard  $H_\infty$  Control, Roll Eccentricity Filter, Thickness Control, Tandem Cold Mills

## Nomenclature

$e$  : Roll eccentricity (mm)  
 $E$  : Young's modulus of the strip ( $\text{kg}_f/\text{mm}^2$ )  
 $f$  : Forward slip ratio  
 $H, h$  : Entry (input) thickness, exit (output) thickness (mm)  
 $K_p$  : Time constant of the housing system  
 $K_s, K_o$  : Time constants of actuators  
 $L$  : Distance between stands (mm)  
 $M$  : Mill modulus ( $\text{kg}_f/\text{mm}$ )  
 $P, P_A$  : Measured roll force, actual roll force ( $\text{kg}_f$ )

$S, S_p$  : Roll gap, roll gap command (mm)  
 $T_b, T_f$  : Backward tension, forward tension ( $\text{kg}_f$ )  
 $V_e, V_o$  : Entry strip velocity, delivery strip velocity (mm/s)  
 $V_R, V_p$  : Roll velocity, roll velocity command (mm/s)

## 1. Introduction

The purpose of control systems in tandem cold mills (TCM) is to improve the thickness accuracy of the strip and to maintain the interstand strip tensions within a reasonable range in the rolling operation. The thickness and tension of the strip are commonly controlled by adjusting the relative gap between top and bottom rolls and by adjusting the roll velocity. Basically, the rolling

\* Corresponding Author,

**E-mail :** sunguk61@hotmail.com

**TEL :** +82-52-259-1075; **FAX :** +82-52-259-2109

Research Center for Machine Part and Materials Processing, University of Ulsan, 29 Muger2-dong, Nam-gu 680-749, Korea. (Manuscript **Received** October 8, 2002; **Revised** July 19, 2003)

process of TCM is a typical multivariable system with strong mutual interaction between the thickness and the tension of the strip. The rolling phenomena also interact with each other through the tension between the neighbour stands. Approaches via the decoupling method (Francis et al., 1975) and optimal regulator theory (Lisini et al., 2000), etc. have been proposed to solve the problem of interaction between variables in a rolling stand. The approach via the decoupling method requires the synthesis of the main controllers for thickness and tension control, as well as the synthesis of the precompensator for decoupling. However, there is no systematic method to design the main controller. The approach via the optimal regulator theory results in an excessively complex structure with a great number of loops, which leads to serious difficulty in actual implementation. A blocked, non-interacting control technique (Hattori et al., 1987) has been suggested to solve the problem of interaction between neighbour stands of TCM apart from the main controller. However, TCM are such large-scale and complicated systems to construct a single type of control system. Actually, in most fields of TCM, the system is divided into a plurality of blocks and proper controllers have been independently applied to those respective stands.

In the cold-rolling mill process, the major sources of output thickness variation are the entry-thickness variation caused from hot mills and/or forward stands of TCM, and the roll eccentricity emerging from a rolling stand itself. With the requirement towards higher thickness accuracy far more strict, the roll eccentricity that had been previously of little practical significance has become a considerable issue since the 1970s. The roll-eccentricity disturbance is directly loaded on the output thickness and thus acts as a noise measurement of it. The effect of roll eccentricity on the "gaugemeter" thickness error prediction technique, well known as the approach for avoiding the process time delay inherent in output-thickness measurement, is a practical problem which can degrade the performance of the system. Solutions that have been tried to correct the roll eccentricity problem associated with the

gaugemeter technique, through on-line estimation of roll eccentricity, mostly signal the compensation of output-thickness error (Teoh et al., 1984) and/or the feedforward eccentricity control (Edwards et al., 1987), etc.

In this paper, a multivariable model for TCM has been established based on the data of an actual process, and in which the entry-thickness variation and roll eccentricity as major disturbances are simultaneously considered. And, in order to overcome the limitation of the gaugemeter technique, a form of observer or soft sensor for the eccentricity signal will be built using other measurements. The on-line estimation of roll-eccentricity signals leads directly to the estimation of instantaneous output thickness. Consequently it allows the output feedback control to achieve high system performances. Also, a main controller to attenuate the disturbances will be synthesized based on the theory of  $H_\infty$  output regulation, which can effectively reflect the knowledge of the frequency and input direction of disturbances in design. Then, in order to effectively reject the roll eccentricity disturbance, a weighting function having some poles on the imaginary axis is introduced. This leads to a non-standard  $H_\infty$  control problem. The design procedures for solving this problem will be analytically presented using the internal model principle. Finally, it has been illustrated by computer simulations that the proposed control method gives higher performance (in both thickness and tension control) compared to previously studied methods.

## 2. Mathematical Model of TCM

Thickness control in a cold mill is necessary to adjust the manipulating variables, such as roll gap and roll velocity to maintain the exit strip thickness within the range of specifications without interrupting the satisfactory operation. The schematic diagram of a stand is shown in Fig. 1 to indicate major rolling parameters. The thickness and the interstand tension of the strip are measured by an X-ray thickness gauge and a tension meter, respectively. Roll force can be measured with a load cell.

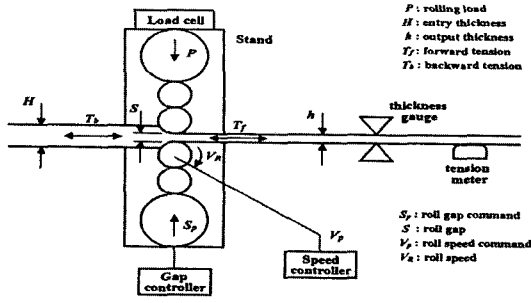

Fig. 1 Rolling process of a mill stand

The rolling phenomenon is nonlinear with multiple inputs and outputs. The rolling control system has been conventionally composed of a set-up system that roughly defines the operating points in consideration of the lack of linearity, and a controller that compensates for the control deviation caused by disturbances. A more precise control function is performed around the operating points. The set-up system defines the nominal values of rolling factors such as roll gap and roll speed, etc. So as to have an expected product based on a production plan (a determination of the production rate, target thickness of the final stand, and the draft, rolling load, and strip tension of each stand, etc.) using the mathematical model that describes the rolling phenomena.

### 2.1 Basic theoretical equations

The basic theoretical equations are the following.

- Rolling force and forward slip ratio

$$P_i = P(H_i, h_i, T_b, T_{fi}) \quad (1)$$

$$f_i = f(H_i, h_i, T_{bi}, T_{fi}) \quad (2)$$

- Equations of actuators

$$\frac{dS_i}{dt} = \frac{1}{K_{si}} (-S_i + S_{pi}) \quad (3)$$

$$\frac{dV_i}{dt} = \frac{1}{K_{vi}} (-V_{Ri} + V_{pi}) \quad (4)$$

- Equation of the housing system

$$\frac{dP_i}{dt} = \frac{1}{K_{pi}} (-P_i + P_{Ai}) \quad (5)$$

- Volume continuity

$$H_i V_{ei} = h_i V_{oi} \quad (6)$$

- Strip velocity

$$V_{oi} = (1 + f_i) V_{Ri} \quad (7)$$

- Exit (output) thickness

$$h_i = S_i + \frac{P_i}{M_i} + e_i \quad (8)$$

- Interstand strip tension

$$\frac{dT_{bi}}{dt} = \frac{EbH_i}{L} (V_{ei} - V_{oi-1}) \quad (9)$$

The subscript  $i$  denotes the stand number.

### 2.2 Linearized equations

The models for the calculation of the rolling force (Hill, 1950) and forward slip (Bland et al., 1948) are commonly expressed in nonlinear forms of rolling parameters. In this paper, modified models are employed since the partial derivatives used to linearize the model can be determined analytically. In order to apply the state space theory, however, the nonlinear Eqs. (1) and (2) must be linearized by considering small perturbations around the nominal operating condition. Also, Eqs. (3) through (9) need to be converted to the form of perturbation equations. Then, combining these perturbation equations yields the state-space linear equations for a mill stand as follows :

$$\dot{\mathbf{x}}_i = \mathbf{A}_i \mathbf{x}_i + \mathbf{B}_i \mathbf{u}_i + \mathbf{E}_i \mathbf{w}_i \quad (10)$$

$$\mathbf{y}_i = \mathbf{C}_i \mathbf{x}_i + \mathbf{F}_i \mathbf{w}_i \quad (11)$$

where state vector  $\mathbf{x}_i$ , control input vector  $\mathbf{u}_i$ , disturbance vector  $\mathbf{w}_i$  and output vector  $\mathbf{y}_i$  (system matrices  $\mathbf{A}_i \in \mathbf{R}^{4 \times 4}$ ,  $\mathbf{B}_i \in \mathbf{R}^{4 \times 2}$ ,  $\mathbf{C}_i \in \mathbf{R}^{2 \times 4}$ ,  $\mathbf{F}_i \in \mathbf{R}^{2 \times 2}$ , are attached in Appendix.) are given as follows, respectively.

$$\mathbf{x}_i = [\Delta S_i \ \Delta P_i \ \Delta V_{Ri} \ \Delta T_{bi}]^T$$

$$\mathbf{u}_i = [\Delta S_i \ \Delta V_{pi}]^T$$

$$\mathbf{w}_i = [\Delta H_i \ e_i]^T$$

$$\mathbf{y}_i = [\Delta h_i \ \Delta T_{bi}]^T$$

where  $\Delta(\cdot)$  means the deviation around the nominal operating point of a variable  $(\cdot)$ .

As shown in the output Eq. (11), the unmeasurable eccentricity signal acts on the exit thickness as measurement noise. In addition, the time delay to exit thickness measurement is inherent

because the X-ray sensor for measuring exit thickness is inevitably placed at some distance away from the roll bite. For these reasons, it is difficult to attenuate the adverse effect of roll eccentricity from any control system unless extra steps are taken.

### 3. Gaugemeter Thickness Prediction with On-line Estimation

#### 3.1 Effect of roll eccentricity

In rolling processes, the non-uniformity of the material properties, variations of strip thickness and hardness, entering the mill causes variations in the rolling load. Also, since the mill stands are elastic and the rolls are deformed under load, these variations in the rolling load result in variations in the effective roll opening which, in turn, cause variations in the exit thickness. The gaugemeter thickness-prediction technique is used to estimate the instantaneous exit thickness from roll force and roll gap measurements. But this estimation is effective only so long as the roll eccentricity can be neglected, as previously mentioned.

From Eq. (8) and ignoring eccentricity  $e$ , the estimate of exit thickness  $\Delta\hat{h}_g$  is written as follows :

$$\Delta\hat{h}_g = \frac{1}{M} \Delta P + \Delta S \quad (12)$$

If the high-gain (state) feedback to force  $\Delta\hat{h}_g$  to zero is used, the effect of other disturbances may be reduced as desired. However, the effect of eccentricity not only causes some deviation to the exit thickness but also feeds a signal to the control system in such a way as to exaggerate this eccentricity effect. For example, when the eccentricity in the back-up roll is causing a reduction in the effective roll opening, an increase in roll force is produced, which, in turn, causes a positive error signal, which then will tend to drive the roll gap in a downward direction, thereby further decreasing the roll gap and causing additional reduction in the exit thickness. Consequently, the high-gain feedback using  $\Delta\hat{h}_g$  may magnify the effect of  $e$  on  $\Delta h$ .

#### 3.2 Eccentricity estimator and thickness predictor

The only way out of the difficulties associated with the gaugemeter technique is to build some form of observer or soft sensor for the unmeasurable eccentricity signal, using other measurements, including roll force, roll gap, and exit thickness. The key to the development of a soft sensor is the fact that the eccentricity signal is nearly periodic, because it arises from the rotation of the backup rolls on the mill.

A characteristic of roll eccentricity disturbances is that they are not stationary. That is, although the initial waveform for each roll may be the result of roll shape and bearing characteristics, the subsequent waveforms in all rolls may change due to non-uniform thermal expansion, wear, and other factors. Therefore, it is desirable to try to identify the eccentricity signals continuously, rather than before the start of rolling.

The eccentricity signal estimation may be expressed from Eq. (8) as follows :

$$\hat{e} = \Delta h - \frac{1}{M} \Delta P - \Delta S \quad (13)$$

We shall assume the knowledge of mill modulus  $M$  and time delay to the thickness gauge  $\tau_d$ .

The key concept in the estimation strategy is used in Eq. (13), with the instantaneous thickness  $\Delta h(t)$  replaced by  $\Delta h_m(t)$ , which corresponds to the exit thickness rolled at a time  $\tau_d$  earlier. Thus, past values of  $\Delta P$  and  $\Delta S$  must be stored so that  $\hat{e}$  at time  $(t - \tau_d)$  can be estimated as :

$$\hat{e}(t - \tau_d) = \Delta h_m(t) - \frac{1}{M} \Delta P(t - \tau_d) - \Delta S(t - \tau_d) \quad (14)$$

If the eccentricity signal has period  $\tau$ , the current value of  $e(t)$  can be estimated as :

$$\hat{e}(t) = \hat{e}(t - \tau) \quad (15)$$

Actually, however, an instantaneous eccentricity signal estimated  $\hat{e}^*$  can be thought of as being the sum of the harmonic components plus measurement noise  $n(t)$ , as shown in Eq. (16). Thus, for using the periodicity of Eq. (15), the components  $e_j$  from the composite signal  $\hat{e}^*$  for each of  $p$  periods must be estimated separately.

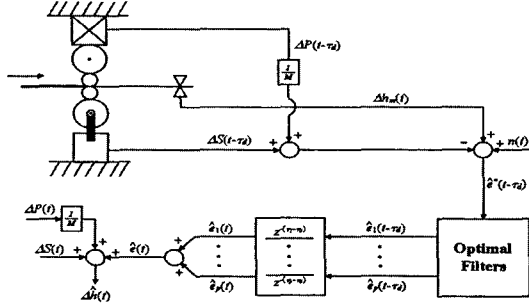

Fig. 2 Eccentricity estimator and output thickness prediction

$$\hat{e}^* = \sum_{j=1}^p G_j \sin(\omega_j t + \varphi_j) + n(t) \quad (16)$$

where the magnitude  $G$  and phase  $\varphi$  are unknown, except for the frequency  $\omega$ .

The required filter for a particular period needs to have a low gain at frequencies other than the corresponding roll-rotation frequency and each of its harmonics. We used a near-optimal Kalman filter (Goodwin et al., 1986) for estimating a single sinusoidal component buried in a composite signal.

Finally, we can obtain the whole eccentricity of Eq. (17) by applying Eq. (15) for the output signals of the filters corresponding to respective periods, and estimate an instantaneous exit thickness of Eq. (18) by using Eq. (13) again.

$$\hat{e}(t) = \sum_{j=1}^p \hat{e}_j(t - \tau_j) \quad (17)$$

$$\Delta \hat{h}(t) = \frac{1}{M} \Delta P(t) + \Delta S(t) + \hat{e}(t) \quad (18)$$

Fig. 2 is the block diagram that shows the on-line estimation technique for the roll eccentricity and exit thickness.

#### 4. Synthesis of the Output Feedback Control System

In this section, the output feedback  $H_\infty$  control system for a cold mill will be synthesized to attenuate effectively not only the entry thickness variation but also the roll eccentricity. Fig. 3 shows the structure of an output feedback system for designing an  $H_\infty$  controller. The constraints on control input signals  $\mu$  are limited by an

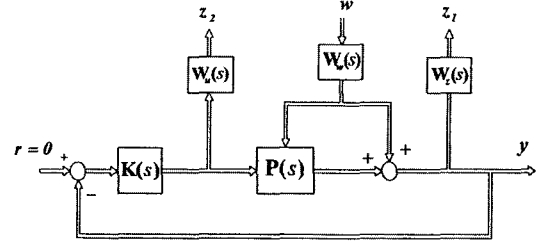

Fig. 3 Feedback control system for the generalized plant with weighting functions

appropriate choice of the weighting  $W_u(s) \in \mathbf{RH}_\infty$ , and the frequency contents of disturbances  $w(w_1, w_2)$  are effectively modeled by the weightings  $W_w(s)$  and  $W_z(s) \in \mathbf{RH}_\infty$ . In particular, out of consideration for the periodicity of the roll eccentricity signal ( $w_2$ ), the weighting  $W_w(s)$  having poles on the imaginary axis will be introduced.

The weightings  $W_u(s)$ ,  $W_w(s)$ ,  $W_z(s)$ , and the plant model  $P(s)$  can be expressed as the following stabilizable and detectable state-space realizations.

$$W_u(s) \equiv \begin{bmatrix} A_u & B_u \\ C_u & D_u \end{bmatrix}, \quad W_w(s) \equiv \begin{bmatrix} A_w & B_w \\ C_w & D_w \end{bmatrix}$$

$$W_z(s) \equiv \begin{bmatrix} A_z & B_z \\ C_z & D_z \end{bmatrix}, \quad P(s) \equiv \begin{bmatrix} A_p & B_p \\ C_p & F_p \ 0 \end{bmatrix}$$

Then, the generalized plant system  $G(s)$  is given by

$$G(s) \equiv \begin{bmatrix} G_{11}(s) & G_{12}(s) \\ G_{21}(s) & G_{22}(s) \end{bmatrix} = \begin{bmatrix} [W_z(I+P)W_w] & [W_zP] \\ 0 & [W_u] \\ (I+P)W_w & P \end{bmatrix} \quad (19)$$

And, representing  $G(s)$  in a state-space realization,

$$G(s) \equiv \begin{bmatrix} A & B_1 & B_2 \\ C_1 & D_{11} & D_{12} \\ C_2 & D_{21} & D_{22} \end{bmatrix} = \begin{bmatrix} A_p & 0 & E_p C_w & 0 & E_p D_w & B_p \\ B_z C_p & A_z & B_z F_p C_w & 0 & B_z F_p D_w & B_u \\ 0 & 0 & A_w & 0 & B_w & 0 \\ 0 & 0 & 0 & A_u & 0 & B_u \\ D_z C_p & C_z & D_z F_p C_w & 0 & D_z F_p D_w & 0 \\ 0 & 0 & 0 & C_u & 0 & D_u \\ C_p & 0 & F_p C_w & 0 & F_p D_w & 0 \end{bmatrix} \quad (20)$$

A non-standard  $H_\infty$  control problem occurs where the weighting function  $W_w(s)$  (and/or  $W_z(s)$ ), having imaginary axis poles, cannot be directly applied to the problem formulation because the first assumption [ $(A, B_2)$  is stabilizable and  $(C, A_c)$  is detectable] in the standard  $H_\infty$  control theory (Doyle et al., 1989) is violated.

**4.1 Non-standard control problem**

Suppose that the closed-loop system  $(G_{22}(s), K(s))$  composed with the plant model  $G_{22}(s)$  and a controller  $K(s)$  is internally stabilizable. Our goal is to design a controller  $K(s)$  that satisfies the following equations.

$$G_{zw}(s) \equiv G_{11} + G_{12}K(I - G_{22}K)^{-1}G_{21} \in RH_\infty \quad (21)$$

$$\|G_{zw}(s)\|_\infty < 1 \quad (22)$$

Figure 4 represents a generalized plant containing either the weighting  $W_w(s)$  or  $W_z(s)$  and having imaginary axis poles that connect to  $w$  and  $z$ , respectively. The realizations of  $W_w(s)$  and  $W_z(s)$  are assumed to be minimal.

$W_w(s)$  is uncontrollable from  $u$  but controllable from  $w$ , and  $W_z(s)$  is unobservable from  $y$  but observable from  $z$ . Hence, to satisfy  $G_{zw}(s) \in RH_\infty$ , the  $j\omega$  modes,  $A_w$  and  $A_z$  in  $W_w(s)$  and  $W_z(s)$  respectively must be cancelled by zeros of  $G_{zw}(s)$ .  $A_w$  then becomes unobservable from  $z$ ,  $A_z$  and uncontrollable from  $w$ . Noting this fact, irrespective of the designing controller  $K(s)$ , the necessary and sufficient conditions for the generalized plant  $G(s)$ , such that  $G_{zw}(s) \in RH_\infty$ , can be analytically summarized as follows. Only the case of having  $j\omega$  modes ( $A_w$ ) in  $W_w(s)$  is stated. The case of  $W_z(s)$  is omitted as the two cases are dual.

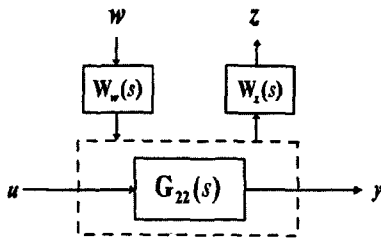

Fig. 4 Weightings having poles on the  $j\omega$  axis

**Proposition :** To satisfy  $G_{zw}(s) \in RH_\infty$ ,

(1) There must exist a column full rank matrix  $V$  satisfying Eq. (23). That is,  $A_w$  must be zero mode of  $G_{12}(s)$ .

$$(A - B_2 D_{12}^+ C_1) V = V A_w, D_{12}^+ C_1 V = 0 \quad (23)$$

where ;

$$D_{12}^+ = (D_{12}^T D_{12})^{-1} D_{12}^T, (D_{12}^+)^T D_{12}^+ = I - D_{12} D_{12}^+ \quad (24)$$

(2) A controller  $K(s)$  that satisfies  $G_{zw}(s) \in RH_\infty$  contains the mode  $A_w$  as a real mode (controllable and observable mode) if and only if Eq. (25) is satisfied.

$$C_2 V = 0 \quad (25)$$

**Remark :** As was stated, Eq. (23) is the condition for which the unstable mode  $A_w$  becomes the unobservable mode of  $z$ . The  $H_\infty$  control problem may be solved only under this condition. However, even if the cancellation of any unstable mode or  $j\omega$  mode takes place in the generalized plant  $G(s)$ , Eq. (23) may also be satisfied. In this case, any controller cannot make  $G_{zw}(s)$  internally stable. Thus, Eq. (25) is the additional condition for excluding such a case, that is, for making the unstable mode ( $A_w$ ) appear in the controller  $K(s)$  as an internal model. This proposition can be derived from the condition for which the mode  $A_w$ , being unobservable from in the state-space realization of  $G_{zw}(s)$ .

Conclusively, if a generalized plant model  $G(s)$  has modes  $A_w$  on the imaginary axis, the prerequisites for the existence of solutions in  $H_\infty$  control problems, that is, the some conditions on the generalized plant  $G(s)$  need to be replaced as follows :

- (a)  $(A, B_2)$  is stabilizable, except for  $j\omega$  mode  $A_w$ .
- (b)  $D_{12}$  is full column rank matrix.
- (c)  $A_w$  must be a zero mode of  $G_{12}(s)$ , but  $G_{12}(s)$  does not have any zeros on  $j\omega$  except  $A_w$ .
- (d)  $C_2 V = 0$ . That is,  $A_w$  is unobservable mode of  $(A - B_2 D_{12}^+ C_1, C_2)$ .

Then, the stabilizing solutions satisfying  $\|G_{zw}(s)\|_\infty < 1$  can be obtained using the concept of the pseudo-stabilizing solution (Mita, 1994) or

the internal-model principle. This paper proposes a procedure for solving this non-standard *H<sub>∞</sub>* control problem using the internal model principle as follows :

- (1) Construct a generalized plant model  $\mathbf{G}(s)$  satisfying the assumptions (a) ~ (d).
- (2) As a controller  $\mathbf{K}(s)$  being designed under the assumption (d) contains  $\mathbf{A}_w$  as the real mode, let  $\mathbf{K}(s) = \mathbf{U}(s)\hat{\mathbf{K}}(s)$ , where  $\mathbf{U}(s)$  has poles of  $\lambda(\mathbf{A}_w)$  and proper stable zeros, and  $\hat{\mathbf{K}}(s)$  is a new controller.
- (3) Derive a new generalized plant  $\hat{\mathbf{G}}(s)$  such that  $\mathbf{G}_{zw} \equiv F_l\{\mathbf{G}, \mathbf{U}\hat{\mathbf{K}}\} = F_l\{\hat{\mathbf{G}}, \hat{\mathbf{G}}\}$  is satisfied. Where  $F_l\{\cdot\}$  means the lower linear fractional transformation (LFT).
- (4) Then,  $\hat{\mathbf{G}}(s)$  becomes the generalized plant model satisfying all the assumptions of the standard *H<sub>∞</sub>* control problem. A stabilizing solution derived from  $\hat{\mathbf{G}}(s)$  and a pseudo-stabilizing solution are numerically equal.
- (5) Find a new controller  $\hat{\mathbf{K}}$  from  $\hat{\mathbf{G}}(s)$  by using main theorems of the *H<sub>∞</sub>* control theory and calculate  $\mathbf{K} = \mathbf{U}\hat{\mathbf{K}}$ .

**4.2 Controller design for TCM**

The entry-thickness variation ( $w_1 = \Delta H$ ) and the roll eccentricity ( $w_2 = e$ ) are considered to be the disturbances of TCM. The entry thickness variation involves welding parts of strips and non-uniformity of strip thickness. This causes the rolls of the forward stands of TCM and/or hot mills, whose roll velocities are relatively slow, to pass to that of the controlled stand. On the other hand, the frequency of roll eccentricity depends on the normal roll velocity ( $\omega_0$ ), so  $w_2$  is a high-frequency signal compared with  $w_1$ .

To reject the effect of roll eccentricity completely, weighting  $\mathbf{W}_w(s)$  is selected. It has poles ( $\pm j\omega_0$ ) on the imaginary axis as follows :

$$\mathbf{W}_w(s) = \frac{s^2 + 2\xi\omega_0s + \omega_0^2}{s^2 + \omega_0^2} \mathbf{I}_2 \quad (26)$$

where  $\xi$  is a design parameter and  $\mathbf{I}_2$  means (2×2) unit matrix. The reason for making the orders of numerator and denominator equal is to make  $\mathbf{D}_{21} (= \mathbf{F}_p\mathbf{D}_w)$  in Eq. (20) have a full row rank.

$\mathbf{W}_z(s)$  and  $\mathbf{W}_u(s)$  are the weightings used to consider the performance and robust-stability, respectively, in the general *H<sub>∞</sub>* mixed-sensitivity problem.  $\mathbf{W}_z(s)$  is selected as Eq. (27), so that its gains are big at the low-frequency domain and small at the high-frequency domain, and  $\mathbf{W}_u(s)$  is selected as Eq. (28), so that its gains are big at the high-frequency domain and  $\mathbf{W}_u(0) = \mathbf{I}_2$ .

$$\mathbf{W}_z(s) = \frac{a}{s+0.001} \mathbf{I}_2 \quad (27)$$

$$\mathbf{W}_u(s) = \frac{20(s+100)(s+500)}{(s+1000)^2} \mathbf{I}_2 \quad (28)$$

The generalized plant model containing these weightings satisfies all the requisites (a) ~ (d) stated in the previous section. Thus, an output-feedback *H<sub>∞</sub>* controller  $\mathbf{K}(s)$  that satisfies Eqs. (21) and (22) can be obtained by using the proposed design procedures. And the design parameters  $\xi$  and  $a$  in weightings are selected through an analysis of the singular-value diagram.

**5. Computer Simulation and Performance Analysis**

The values of major parameters used for the simulation are as follows.

Figure 5 shows the singular-value diagram of the closed-loop transfer function  $\mathbf{G}_{zw}(s)$ . It has sufficiently small gains not only at the low frequency domain (below 1 Hz) of the entry-thickness variation but also at the frequencies (near 4 Hz) of the roll-eccentricity signal.

Fig. 6 shows the disturbance signals for simulation. The entry-thickness variation ( $w_1$ ) consisted of a separate step and a 1Hz periodic signal

**Table 1** Parameter specification

Item	Symbol	Specification
Mill modulus	M	0.39 MN/mm
Measuring time delay of the exit thickness	$\tau_d$	0.15 sec
Nominal backup roll period (frequency)	$\tau_0(\omega_0)$	0.25 sec (25.13 rad/sec)
Design parameters	$\xi$	3
	$a$	20

in consideration of the weld junction and output thickness variation of the backward stand. The roll eccentricity ( $w_2$ ) contained the first and third

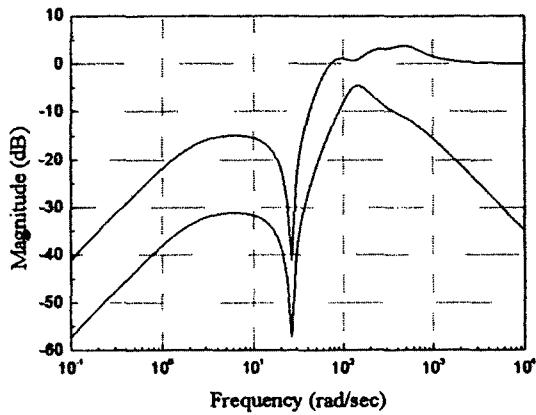
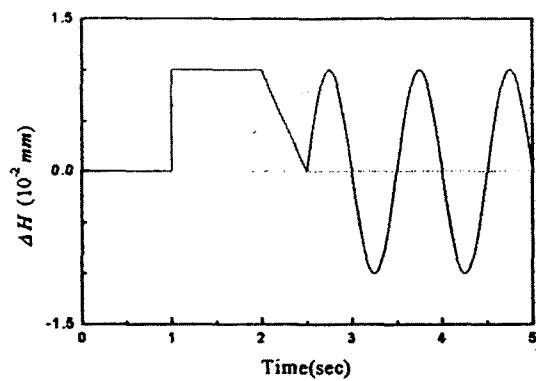
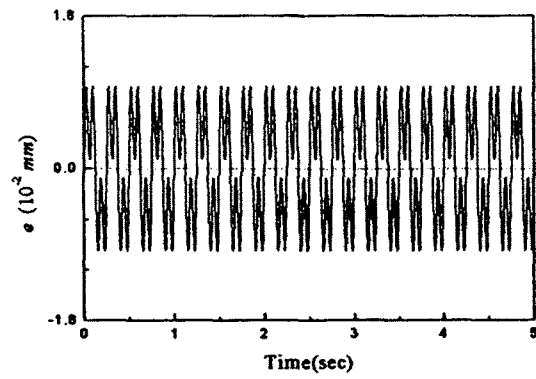

Fig. 5 Singular value diagram of the closed-loop transfer function matrix from disturbances to outputs



(a)



(b)

Fig. 6 Entry thickness variation and roll eccentricity as disturbances

harmonics of the nominal period of the corresponding backup roll.

Figures 7 and 8 show the disturbance attenuation performances of the proposed  $H_\infty$  control and an integrated control, composed of LQ-state feedback control and feedforward eccentricity control, for exit thickness variations and tension variations, respectively. It has been verified by much research that as disturbance input, in consideration of only the entry-thickness variation and the roll eccentricity, respectively, the LQ-state feedback control and the feedforward eccentricity control, through the roll-eccentricity estimation, can give satisfactory performances of the exit thickness. However, as the integrated-control method is applied to the two disturbances simultaneously, it degrades the removal effects of both disturbances as compared with that of the LQ-

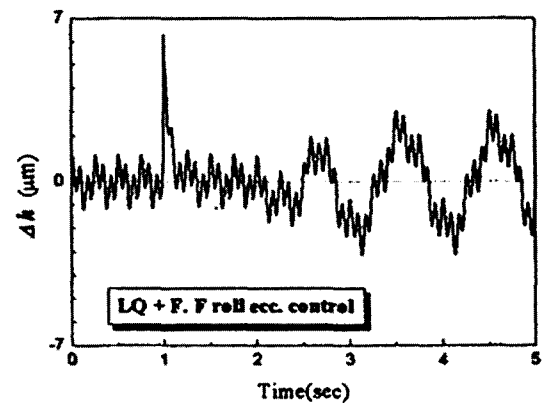

(a)

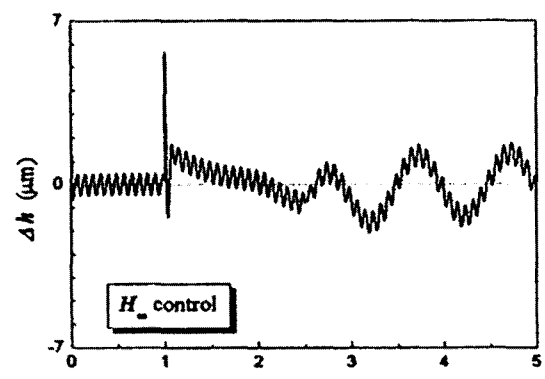

(b)

Fig. 7 Controlled output thickness responses



state feedback control and the feedforward eccentricity control, respectively. That is, the LQ feedback control exaggerates the effect of the roll eccentricity, and the feedforward eccentricity control degrades the attenuation effect of the entry-thickness variation. On the other hand, the proposed  $H_\infty$  control shows a remarkable improvement on the removal performance of not only the roll eccentricity but also the entry thickness variation. This means that the  $H_\infty$  control method effectively reflects the characteristics of two disturbances that differ from each other in both input direction and frequency spectrum. Furthermore, if any controller could reduce not only the exit-thickness variation but the tension variation sufficiently, the interstand interference effect in tandem cold mills could be neglected. This may allow for an independent control system to be

built for each rolling stand of TCM.

## 6. Conclusion

This paper proposes an  $H_\infty$  controller design method that can effectively attenuate the disturbances, entry thickness variation and roll eccentricity, that occur simultaneously in rolling stands of TCM. In particular, in order to reject the roll-eccentricity disturbance, an on-line estimator of eccentricity and output-thickness signals is built. And, in designing the disturbance-rejection  $H_\infty$  controller, the non-standard  $H_\infty$  problem, that results from selecting a weighting that has imaginary axis poles, has been analytically discussed, and its design procedures are proposed. It was illustrated by a computer simulation that the proposed  $H_\infty$  control method gives better performances in the rejection of the disturbances of not only the roll eccentricity but also the entry-thickness variation, compared with the existing methods of the LQ-state feedback control and the feedforward roll-eccentricity control.

## Acknowledgment

This work was supported by 2002 Research Fund of University of Ulsan.

## References

- Bland, D. R. and Ford, H., 1948, "The Calculation of Roll Force and Torque in Cold Strip Rolling with Tensions," *Proc. of Institute of Mech. Eng.*, Vol. 159, pp. 144~153.
- Doyle, J. C., Glover, K., Khargoneker, P. P. and Francis, B. A., 1989, "State-space Solutions to Standard  $H_\infty$  and  $H_2$  Control Problems," *IEEE Trans. on Automatic Control*, Vol. 34, pp. 831~847.
- Edwards, J., Thomas, P. and Goodwin, G. C., 1987, "Roll Eccentricity Control for Strip Rolling Mill," *Special Case Study Paper, 10th IFAC World Congress, Munich*, Vol. 2, pp. 200~211.
- Francis, B. A. and Wonham, W. M., 1975, "The Internal Model Principal for Linear Multivariable Regulators," *Applied Mathematics & Opti-*

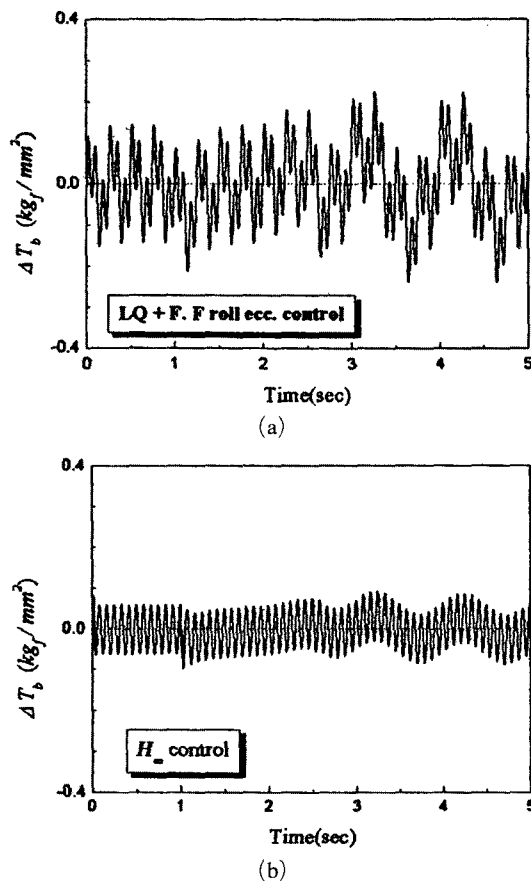

Fig. 8 Controlled backward tension responses

mization, Vol. 2, No. 2, pp. 170~194.

Goodwin, G. C., Evans, R. J., Leal, R. L. and Feik, R. A., 1986, "Sinusoidal Disturbance Rejection with Application to Helicopter Flight Data Estimation," *IEEE ASSP*, Vol. 34, pp. 479~485.

Hattori, S. and Katayama, Y., 1987, "Development of Blocked Non-interacting Optimal Control System for Rolling Mill Control," *30th Automatic Control Federation, A Lecture*, pp. 3059~3060.

Hill, R., 1950, "Relation Between Roll Force, Torque and the Applied Tensions in Strip Rolling," *Proc. of Institution of Mech. Eng.*, Vol. 163, pp. 135~140.

Lisini, G. G., Toni, P. and Valigi, M. C., 2000, " $H_\infty$  Control System for a Four-high Stand Rolling Mill," *Proc. of Institute of Mech. Eng.*, Vol. 214, Part I, pp. 79~86.

Mita, T., 1994,  *$H_\infty$  Control* (in Japanese), Shokodo, Tokyo, Japan.

Teoh, E. K., Goodwin, G. C., Edwards, W. J. and Davies, R. G., 1984, "An Improved Thickness Controller for a Rolling Mill," *Proc. 9th IFAC Congress, Budapest*, pp. 1741~1746.

### Appendix

System matrices ( $\mathbf{A}_i$ ,  $\mathbf{B}_i$ ,  $\mathbf{C}_i$ ,  $\mathbf{E}_i$  and  $\mathbf{F}_i$ )

$$\mathbf{A}_i = \begin{bmatrix} -1/T_{si} & 0 & 0 & 0 \\ a_{2,1}^i & a_{2,2}^i & 0 & a_{2,4}^i \\ 0 & 0 & -1/T_{vi} & 0 \\ a_{4,1}^i & a_{4,2}^i & a_{4,3}^i & a_{4,4}^i \end{bmatrix}$$

$$\mathbf{B}_i = \begin{bmatrix} 1/T_{si} & 0 \\ 0 & 0 \\ 0 & 1/T_{vi} \\ 0 & 0 \end{bmatrix}, \quad \mathbf{C}_i = \begin{bmatrix} 1 & 1/K_i & 0 & 0 \\ 0 & 0 & 0 & 0 \end{bmatrix}$$

$$\mathbf{E}_i = \begin{bmatrix} 0 & 0 \\ e_{2,1}^i & e_{2,2}^i \\ 0 & 0 \\ e_{4,1}^i & e_{4,2}^i \end{bmatrix}, \quad \mathbf{F}_i = \begin{bmatrix} 1 & 0 \\ 0 & 0 \end{bmatrix}$$

where

$$a_{2,1}^i = \frac{1}{T_{pi}} \left( \frac{\partial \Delta P_{Ai}}{\partial \Delta H_i} \right)$$

$$a_{2,2}^i = \frac{1}{T_{pi}} \left\{ \frac{1}{M_i} \left( \frac{\partial \Delta P_{Ai}}{\partial \Delta H_i} \right) - 1 \right\}$$

$$a_{2,4}^i = \frac{1}{T_{pi}} \left( \frac{\partial \Delta P_{Ai}}{\partial \Delta T_{bi}} \right)$$

$$a_{4,1}^i = \frac{E_i b}{L_i} \left\{ \left( \frac{\partial \Delta f_i}{\partial \Delta h_i} \right) h_i V_{Ri} + V_{oi} \right\}$$

$$a_{4,2}^i = \frac{E_i b}{L_i M_i} \left\{ \left( \frac{\partial \Delta f_i}{\partial \Delta h_i} \right) h_i V_{Ri} + V_{oi} \right\}$$

$$a_{4,3}^i = \frac{-E_i H_i b}{L_i} (1 + f_{i-1})$$

$$a_{4,4}^i = \frac{E_i b}{L_i} \left\{ \left( \frac{\partial \Delta f_i}{\partial \Delta T_{bi}} \right) h_i V_{Ri} - \left( \frac{\partial \Delta f_{i-1}}{\partial \Delta T_{fi-1}} \right) H_i V_{Ri-1} \right\}$$

$$e_{2,1}^i = \frac{1}{T_{pi}} \left( \frac{\partial \Delta P_{Ai}}{\partial \Delta H_i} \right)$$

$$e_{2,2}^i = \frac{1}{T_{pi}} \left( \frac{\partial \Delta P_{Ai}}{\partial \Delta H_{fi}} \right)$$

$$e_{4,1}^i = \frac{E_i b}{L_i} \left\{ \left( \frac{\partial \Delta f_i}{\partial \Delta H_i} \right) h_i V_{Ri} - V_{oi-1} \right\}$$

$$e_{4,2}^i = \frac{E_i b}{L_i} \left\{ \left( \frac{\partial \Delta f_i}{\partial \Delta h_i} \right) h_i V_{Ri} - V_{oi} \right\}$$