

(Technical Note)

Effects of Pool Subcooling on Boiling Heat Transfer in an Annulus

Myeong-Gie Kang

Andong National University

388 Songchun-dong, Andong, Gyeongbuk 760-749, Korea

mgkang@andong.ac.kr

(Received February 27, 2004)

Abstract

Effects of liquid subcooling on pool boiling heat transfer in an annulus with an open bottom have been investigated experimentally. A tube of 19.1 mm diameter and the water at atmospheric pressure have been used for the test. Up to 50°C of liquid subcooling has been tested and experimental data of the annulus have been compared with the data of a single unrestricted tube. Temperatures on the heated tube surface fluctuate only slightly regardless of the heat flux in the annulus, whereas high variation is observed on the surface of the single tube. An increase in the degree of subcooling decreases heat transfer coefficients greatly both for the single tube and the annulus. Heat transfer coefficients increase suddenly at $\Delta T_{sub} \leq 10^\circ\text{C}$ and much greater change in heat transfer coefficients is observed at the annulus. To obtain effects of subcooling on heat transfer quantitatively, two new empirical equations have been suggested, and the correlations predict the empirical data within $\pm 30\%$ error bound excluding some data at lower heat transfer coefficients.

Key Words : pool boiling, vertical tube, subcooling, annulus

1. Introduction

Pool boiling heat transfer has been studied over a long period of time and, recently, has been the subject of widespread investigation in nuclear power plants for application to advanced light water reactors [1-3]. Many passive heat exchangers that transfer decay heat to a water

tank by pool boiling have been adopted in advanced nuclear reactors in order to meet inherent safety goals [3,4]. These passive safety systems maintain the coolant temperature under a required value within a fixed time [5,6]. Among the design parameters, two important subjects are (1) identification of effects of subcooling on pool boiling heat transfer and (2) determination of a

means of increasing heat transfer.

For the AP600 case, the water in the in-containment refueling water storage tank (IRWST) is subcooled initially. Approximately 2 hours are required for the water to become saturated after the system commences operation [7]. According to Judd et al. [8], surface temperatures of heat exchanging tubes are increased due to the decrease in the density of active nucleation sites. This results in an increase in the temperatures of fluid in the tube. The increase in reactor coolant temperatures eventually leads to reactor damage

following departure from nucleate boiling (DNB) on the fuel rod surfaces. Therefore, obtaining the proper heat transfer coefficient on the heat exchanging tube surface in subcooled water is critical.

Bradfield [9] published some experimental results on subcooled boiling in the transition region. Judd et al. [8] investigated effects of subcooling on boiling heat transfer in the nucleate boiling region. They theoretically studied the relation between the degree of subcooling and superheating through analyses previous

Table 1. Summary of Previous Works About Crevice Effects on Pool Boiling Heat Transfer

Author	Remarks
Yao and Chang (1983)	- heater: stainless steel tube ($D = 25.4\text{mm}$, $L = 25.4$ and 76.2mm) - liquid: R-113, acetone, and water at 1 atm - geometry: vertical annuli with closed bottoms - gap sizes: 0.32, 0.80, and 2.58mm
Hung and Yao (1985)	- heater: stainless steel tube ($D = 25.4\text{mm}$, $L = 25.4 \sim 76.2\text{mm}$) - liquid: R-113, acetone, and water at 1 atm - geometry: horizontal annuli - gap sizes: 0.32, 0.80, and 2.58mm
Fujita et al. (1988)	- heater: copper plate (30×30 and $30 \times 120\text{mm}$ in width \times length) - liquid: water at 1 atm - geometry: • vertical and inclined spaces between rectangular surfaces • periphery; open, closed sides, closed sides and bottom - gap sizes: 0.15, 0.60, 2.0 and 5.0mm
Bonjour and Lallemand (1998)	- heater: copper plate ($60 \times 120\text{mm}$ in width \times length) - liquid: R-113 at 1 atm - geometry: • vertical and inclined space between rectangular surfaces • periphery; sides and bottom are left open - gap sizes: 0.3, 0.50, 1.0 and 2.0mm
Kang (2001)	- heater: stainless steel tube ($D = 25.4\text{mm}$, $L = 570\text{mm}$) - liquid: water at 1 atm - geometry: vertical annuli with open or closed bottoms - gap sizes: 3.9 and 15mm
Kang and Han (2002)	- heater: stainless steel tube ($D = 25.4\text{mm}$, $L = 570\text{mm}$) - liquid: water at 1 atm - geometry: vertical annuli with open or closed bottoms - gap sizes: 3.9~44.3mm

experimental results. Celata et al. [10] published results comparing pool and forced convective boiling. Some experimental results have recently been published that identify the relation between subcooling and boiling heat transfer, with consideration of the heating surface as a wire [11-13]. Kang [7] published some preliminary studies of a tube to investigate effects of subcooling on pool boiling heat transfer and thermal mixing by using a vertically installed stainless steel tube of 19.1 mm diameter and water.

Summarizing the previous results, effects of subcooling on boiling heat transfer have been extensively studied in terms of regarding a fluid in forced circulation and/or heating geometry in the form of a wire. However, there has been very little reported study on subcooled pool boiling on a tube. Since mechanisms of forced convective boiling are different from pool boiling [1], they should be treated separately. Moreover, results of wires cannot be applied to tubes without significant modification, since there are many differences in heat transfer between tubes and wires [14].

Although many researchers have investigated effects of heater geometries on boiling heat transfer, knowledge on confined spaces and pool boiling heat transfer is still very limited. However, gap effects in flow boiling have been widely studied [15-17]. Studies on the crevices can be divided into two categories, annuli [18,19] and plates [20, 21]. Some previous results related to crevice effects on pool boiling heat transfer are summarized in Table 1. In addition to the geometric conditions, flow to the crevices can be limited. Some geometry may have the form of a closed bottom [18, 20-22].

Through a literature survey, it can be concluded that further on annuli with open bottoms is required. Moreover, there has been very little study on subcooling effects despite that this field is very important in terms of industrial applications.

Therefore, in order to investigate potential areas for improvement of thermal design of heat exchangers and to supplement the data of previous studies in this area, subcooled pool boiling heat transfer in an annulus has been investigated at atmospheric pressure.

2. Experiments

A schematic view of the present experimental apparatus and test sections is shown in Fig. 1. The water storage tank (Fig. 1(a)) is made of stainless steel and has a rectangular cross-section (950 × 1300 mm) and a height of 1400 mm. This tank has a glass view port (1000 × 1000 mm), which permits viewing of the tubes. The tank has a double container system. The sizes of the inner tank are 800 × 1000 × 1100 mm (depth × width × height). The bottom side of the inner tank is situated 200 mm above the bottom of the outer tank. The inside tank has several flow holes (28 mm in diameter) to allow fluid inflow from the outer tank. To diminish the effects of inflow from the outside tank, holes are situated 300 and 800 mm high from the bottom of the inside tank. Four auxiliary heaters (5 kW/heater) were installed at the space between the inside and the outside tank bottoms to boil the water and to maintain the required condition. To reduce heat loss to the environment, the left, right, and rear sides of the tank were insulated by glass wool of 50 mm thickness. The heat exchanger tubes are simulated by resistance heaters (Fig. 1(b)) made of a very smooth stainless steel tube ($L = 540$ mm and $D = 19.1$ mm). The surface of the tube was finished through a buffing process so as to have a smooth surface. Electric power was supplied through the bottom side of the tube. For the test, 220 V AC was used. Figures 1 (c) and (d) show a glass tube and its supporter and the assembled test section, respectively.

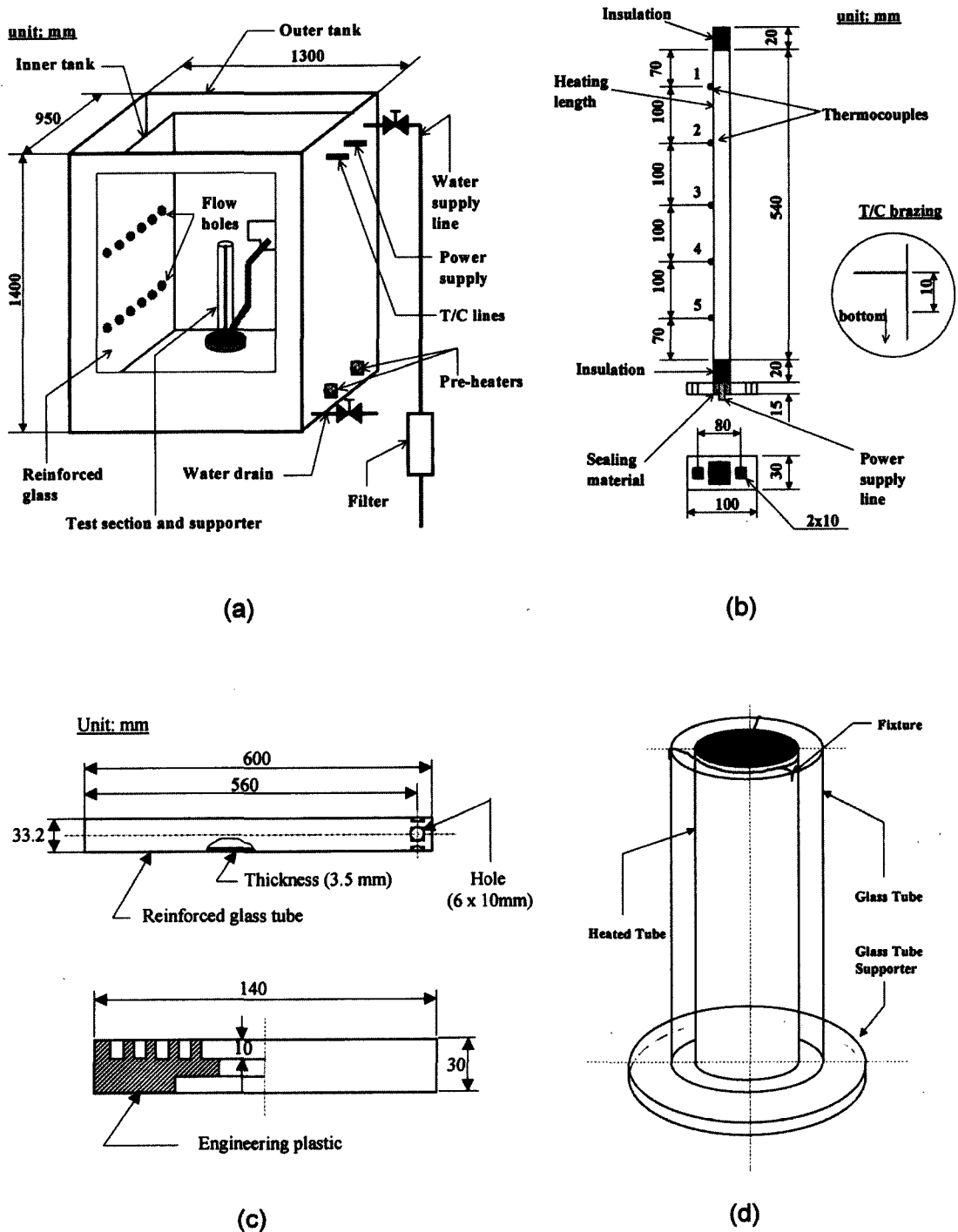

Fig. 1. Schematic Diagram of the Experimental Apparatus

The tube outside was instrumented with five T-type sheathed thermocouples (diameter is 1.5 mm). The thermocouple tip (about 10 mm) was bent at a 90-degree angle and the bent tip was brazed on the tube wall. The locations of the thermocouples are 70, 170, 270, 370, and 470 mm from the heated tube bottom, as shown in Fig. 1(b). The water temperatures were measured with six sheathed T-type thermocouples placed vertically at a corner of the inside tank (see Fig. 2). Bulk temperatures in the annulus were measured with five T-type thermocouples at the location of the brazed thermocouples on the tube surface. All thermocouples were calibrated at a saturation value. To measure and/or control the supplied voltage and current, two power supply systems (each having three channels for reading of both voltage and current in digital values) were used. The capacity of each channel is 10 kW.

For the tests, the heat exchanger tubes are placed vertically at the supporter and a glass tube supporter is used to fix a glass tube. To make annular conditions, a glass tube with a 33.2 mm inner diameter was used. Therefore, the gap size of the annulus is 7.05 mm. Six holes of 10 mm diameter were manufactured at one end of the glass tube and the side with holes was placed at the bottom. A fixture made of slim wires was inserted into the upper side of the gap to maintain the space between the heating tube and the glass tube.

After the water storage tank was filled with water until the initial water level was 1100 mm from the outer tank bottom, the water was heated using four pre-heaters at constant power (5 kW/heater). Through the heating process, temperatures of the water were measured. When the water temperature (T_{wat}) reached the required value, power to the pre-heaters was turned off and electricity was supplied to the heated tube. The temperatures of the water and tube surfaces were

measured while controlling heat fluxes. In this manner a series of experiments was performed for various liquid subcooling.

The heat flux from the electrically heated tube surface is calculated from the measured values of the input power as follows:

$$q'' = \frac{q}{A} = \frac{VI}{\pi DL} = h_b(T_w - T_b) = h_b \Delta T \quad (1)$$

where V and I supplied voltage (in volt) and current (in ampere), and D and L are the outside diameter and the length of the heated tube, respectively. T_w represent the measured temperatures of the tube surface and water in the annulus, respectively. The tube surface temperatures T_w and T_b used in Eq. (1) are the arithmetic average values of the temperatures measured by thermocouples.

The error bounds of the voltage and current meters used for the test were $\pm 0.5\%$ of the measured value. Therefore, the calculated power (voltage \times current) has 1.0% error bound. Since the heat flux has the same error bound as the power, the uncertainty in the heat flux is estimated to be $\pm 1.0\%$. When evaluating the uncertainty of the heat flux, the error of the heat transfer area is not taken into account since the uncertainties of the tube diameter and the tube length are ± 0.1 mm and its effect on the area is negligible.

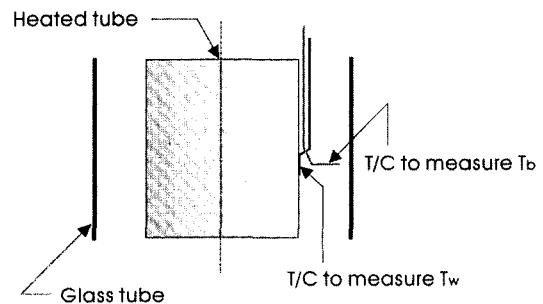

Fig. 2. Locations of Thermocouples in the Annulus

The measured temperature has uncertainties originated from the thermocouple probe itself, thermocouple brazing, and translation of the measured electric signals to digital values. To evaluate the error bound of the thermocouple probe, three thermocouples brazed on the tube surface were submerged in an isothermal bath containing water. The measured temperatures were compared with the set temperature (80 °C) of an isothermal bath of $\pm 0.01^\circ\text{C}$ accuracy. Since the time to complete one set of the present test was less than 1 hour, the elapsed time to estimate the uncertainty of the thermocouple probes was set as 1 hour. According to the results, the deviation of the measured values from the set value is within $\pm 0.1^\circ\text{C}$ including the accuracy of the isothermal bath. Since the thermocouples were brazed on the tube surface, the conduction error through the brazing metal must be evaluated. The brazing metal is a type of brass and the averaged brazing thickness is less than 0.1 mm. The maximum temperature decrease due to this

brazing is estimated as 0.15°C . To estimate the total uncertainty of the measured temperatures the translation error of the data acquisition system must be included. The error bound of the system is $\pm 0.05^\circ\text{C}$. Therefore, the total uncertainty of the measured temperatures is defined by adding the above errors, giving a value of $\pm 0.3^\circ\text{C}$.

3. Results and Discussion

Figures 3 shows the temperature distribution along the tank height as time elapses. The prerequisite condition to evaluate the effects of liquid subcooling on pool boiling heat transfer is uniform temperature distribution inside the water tank. To prevent thermal stratification [7] along the tank height without utilizing a stirrer a double container type tank was adopted. As shown in the figure, no significant temperature difference exists between the uppermost (T/C A) and the lowermost (T/C E) the rmocouple readings. At $T_w = 60^\circ\text{C}$ and $q'' = 110\text{ kW/m}^2$ the difference

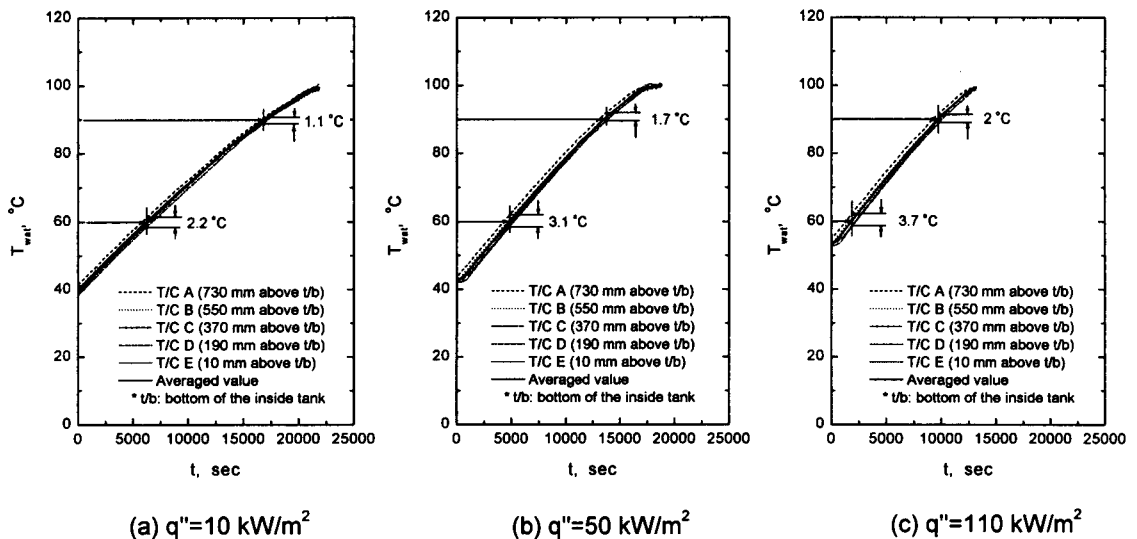

Fig. 3. Changes in Local Temperatures of Water in the Tank

between two local values is the largest. At higher heat flux the upper region of the water becomes warm more rapidly than the lower regions due to bubbles coming from the lower side. As the degree of subcooling is higher, flow circulation is very limited around the upper region. Therefore, the largest difference between two temperatures is observed at higher subcooling and heat flux. The

difference decreases gradually as the water becomes saturated. Local temperatures measured at five different heights were averaged to determine the degree of subcooling of water.

Figure 4 shows changes in the average water temperature during the test of $\Delta T_{sub}=40^\circ\text{C}$. For the period, the temperature fluctuates within $\pm 0.1^\circ\text{C}$, which can thus be neglected. Since T_w in Eq. (1) is the averaged temperature of measured values, local values are shown in Fig. 5. Results for two subcooling tests at 50 and 0°C are shown in the figure. As shown in the figure, changes in the measured local values decrease as the degree of subcooling and the heat flux decrease. Figure 6 shows changes in bulk temperatures in the annulus. The bulk temperature is slightly larger than the pool temperature. The difference between the two temperatures decreases as the degree of subcooling increases and/or the heat flux decreases.

Figure 7 shows curves of heat flux versus average tube surface temperature. The slopes of the curves for the annulus are much steeper than those of the single tube. Change in q'' from 10 to 110 kW/m^2

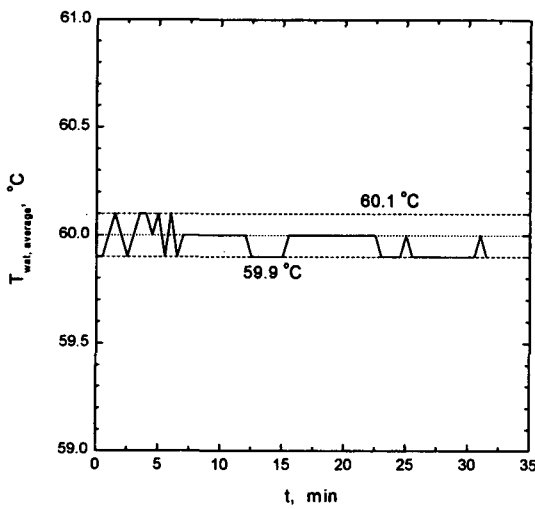

Fig. 4. Changes in the Average Water Temperature

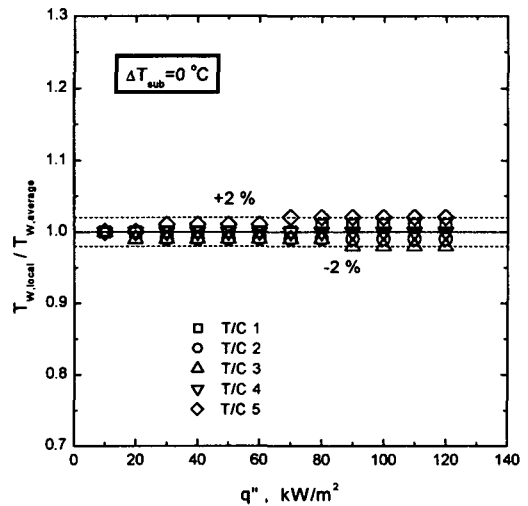
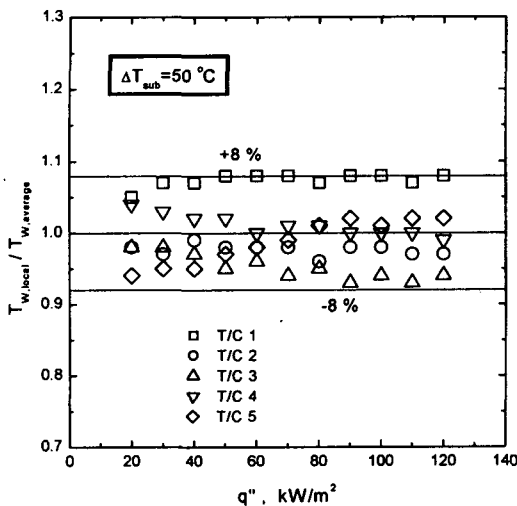

Fig. 5. Comparison Local Wall Temperatures with Average Values in the Annulus

results in a 19.0 % increase in T_w (from 86.9 °C to 103.4 °C) for the single tube while only an 11.8 % change in T_w (from 86.4 °C to 96.6 °C) is observed at the annulus. As the degree of subcooling increases, the slope of the curve decreases for both the single tube and the annulus. However, the difference between tube

wall temperatures decreases as the heat flux increases regardless of the degree of subcooling. At $T_w < 100$ °C, the major heat transfer on the surface is due to single phase natural convection whereas regions of local boiling exists on the surface.

To observe bubble movement in the tank several photos of boiling on the tube surface have been taken and are shown in Figs. 8 and 9. Photos of 70 and 110 kW/m² are compared as the degree of subcooling increases from 0 to 20 °C. As ΔT_{sub} approaches 0 °C, the sizes of bubbles on the surface increase and the departed bubbles move to the water surface. At the higher subcooled case, the sizes of the departed bubbles are tiny (bubble diameter is nearly 1-2 mm) and the departed bubbles are almost collapsed before they reach the water surface. As the degree of subcooling decreases, the sizes of the departed bubbles increases. Therefore, the intensity of liquid agitation due to the departed bubbles increases as the liquid becomes saturated. Photos of the annulus show much earlier bubble growth than in the single tube. This results in much stronger liquid

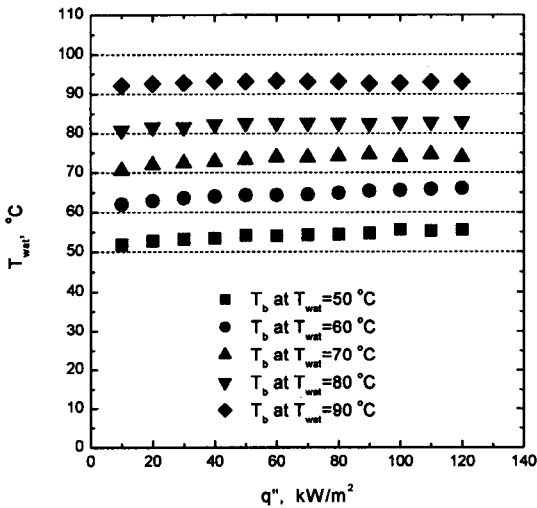
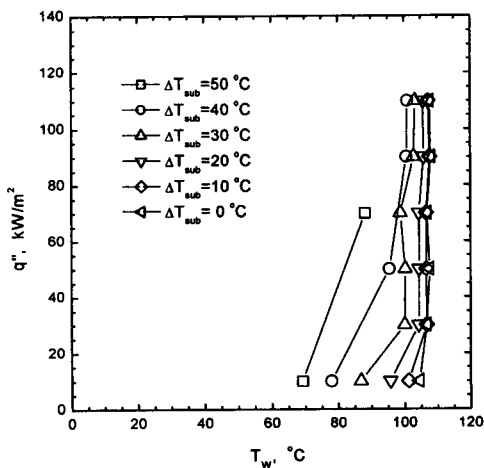
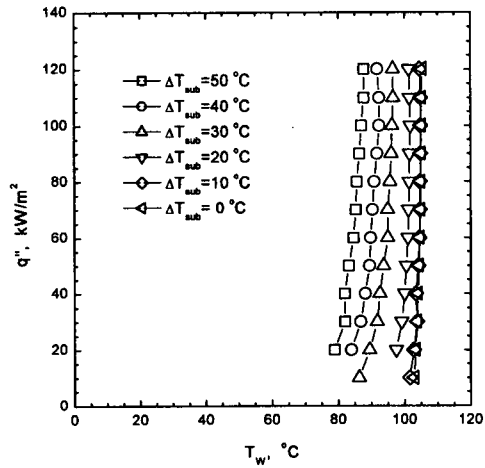

Fig. 6. Changes in Bulk Temperatures in the Annulus



(a) single tube



(b) annulus

Fig. 7. Heat Flux Versus Wall Temperature as the Degree of Subcooling Changes

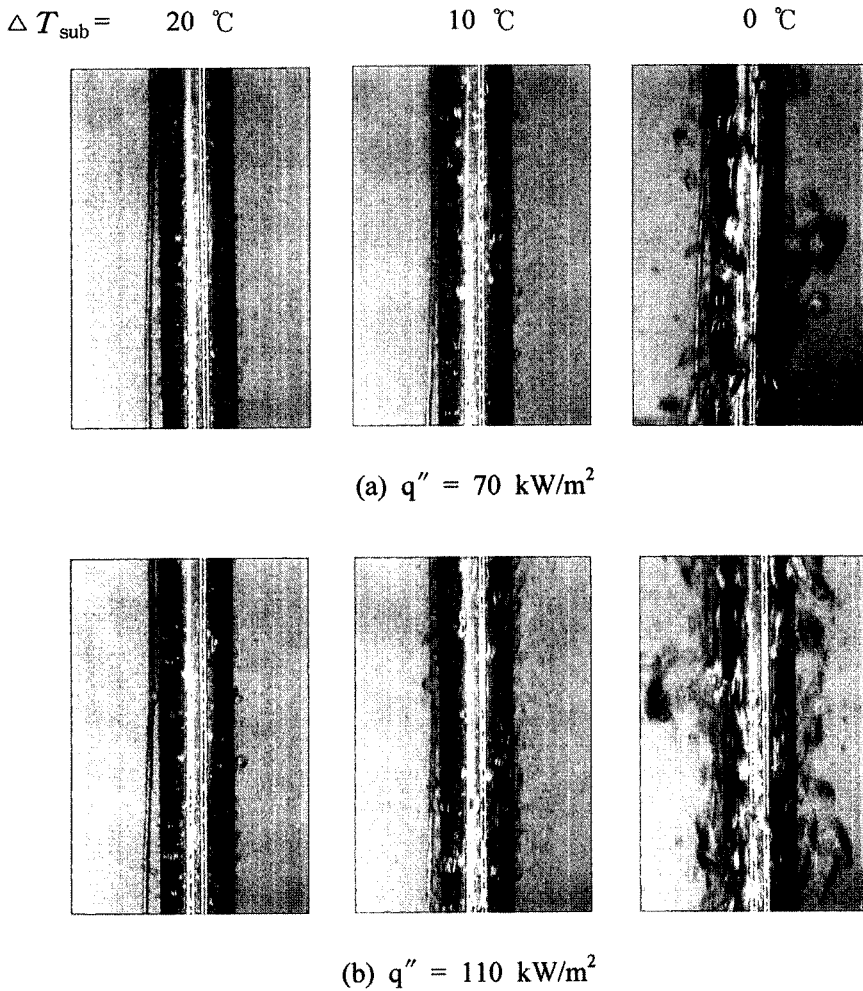

Fig. 8. Photos of Subcooled Boiling on the Unrestricted Single Tube Surface

agitation, which could be the main source of the increase in heat transfer coefficients.

Figure 10 shows variations in heat transfer coefficients as subcooling changes, where the results of the single tube and the annulus are compared. The heat transfer coefficient increases as the level of subcooling is decreased, regardless of tube conditions. The rate of increase in the heat transfer coefficient is larger for the annulus. As ΔT_{sub} decreases from 50 to 0 °C at $q' = 70$

kW/m^2 , 461 % (from 1.8 to 10.1 $\text{kW/m}^2 \cdot ^\circ\text{C}$) and 539 % (from 2.3 to 14.7 $\text{kW/m}^2 \cdot ^\circ\text{C}$) increases in heat transfer coefficients are observed at the single tube and the annulus, respectively. A large difference between the heat transfer coefficients of the single tube and the annulus at $\Delta T_{sub} \leq 10^\circ\text{C}$ is observed. However, no visible difference is observed between the two heat transfer coefficients, at $\Delta T_{sub} > 10^\circ\text{C}$. The tendency at higher subcooling is due to single-

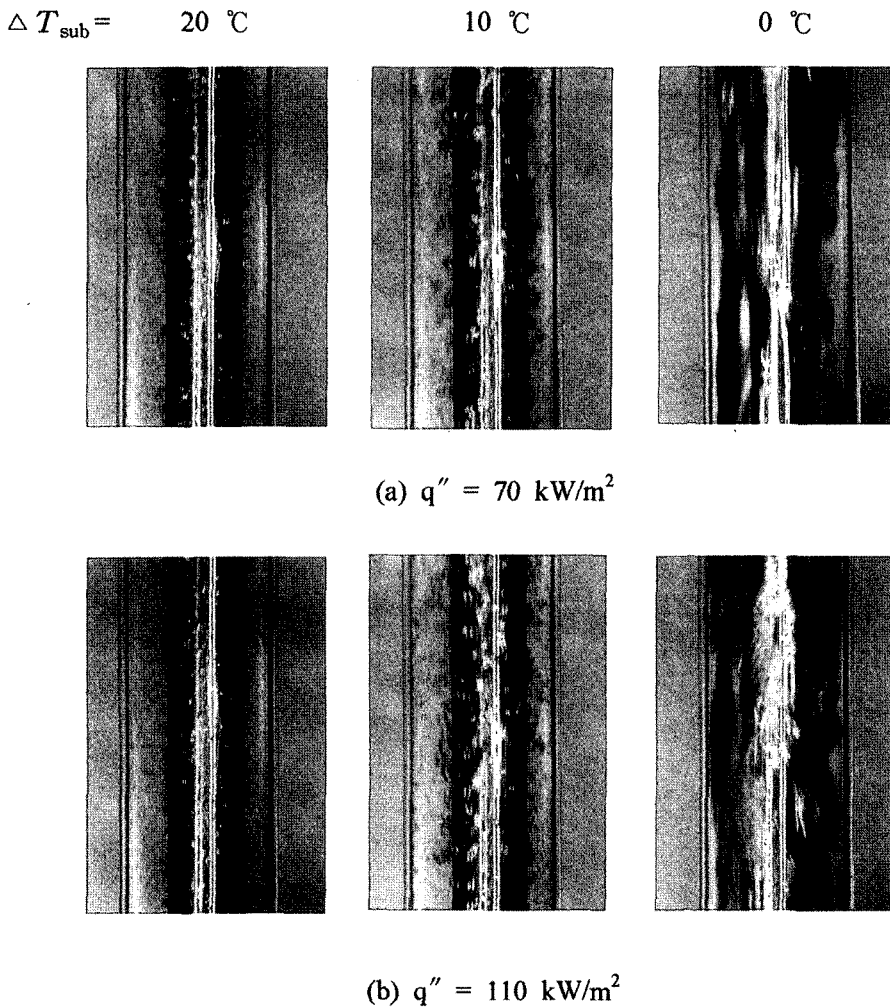

Fig. 9. Photos of Subcooled Boiling on the Tube Surface in the Annulus

phase heat transfer, which is the major mechanism in these regions, as Judd et al. [8] suggested. At these regions the intensity of liquid agitation due to creation and departure of bubbles is not effective in terms of changing the heat transfer rate. The sizes of bubbles created on the tube surface and the density of nucleation sites are very small and, moreover, bubbles departed from the surface disappear while moving through the water, as shown in Figs. 8 and 9. The sudden

increase in heat transfer coefficients at $\Delta T_{sub} \leq 10^\circ\text{C}$ is attributed to the increase in the intensity of liquid agitation followed by an increase in the nucleation sites density. More bubbles generated due to the increased nucleation sites and these bubbles grow to larger bubbles by coalescing with nearby bubbles. Clusters of bubbles agitate the relevant liquid and thereafter the liquid accesses the heating surface easily. Since the effected region affected by the moving bubbles is much

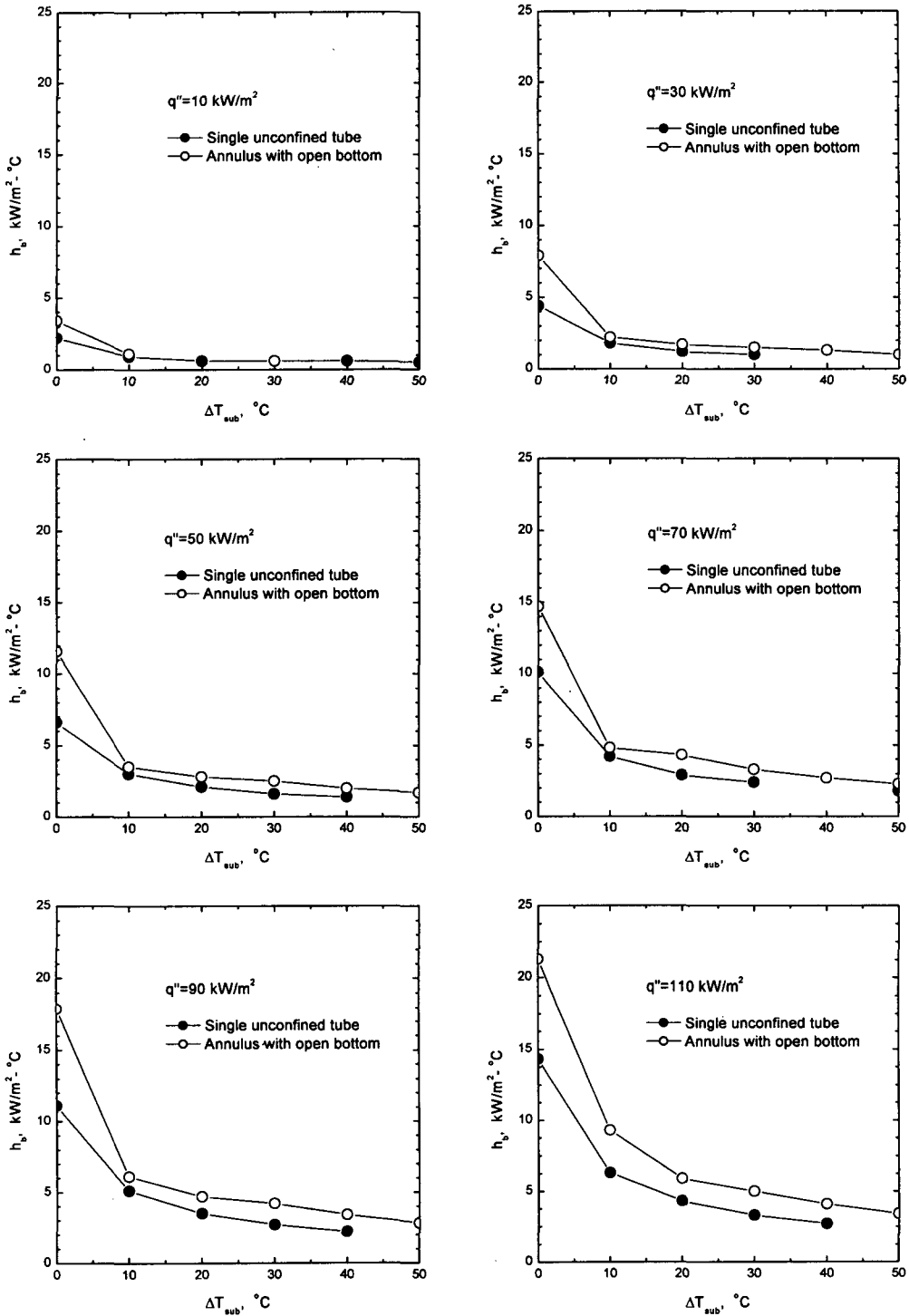

Fig. 10. Variations in Heat Transfer Coefficients as the Degree of Subcooling Changes

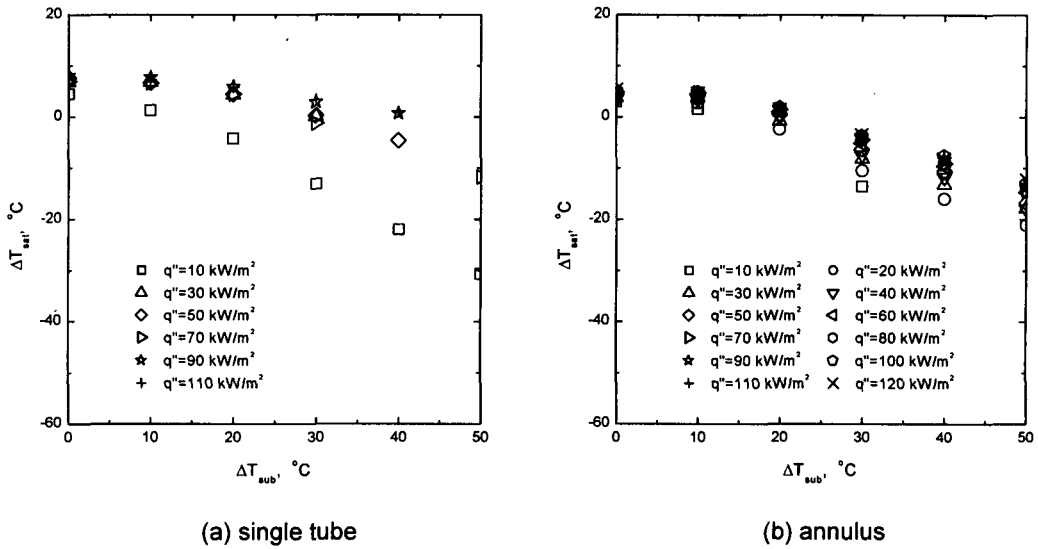

Fig. 11. Curves of Tube Wall Superheating Versus Subcooling

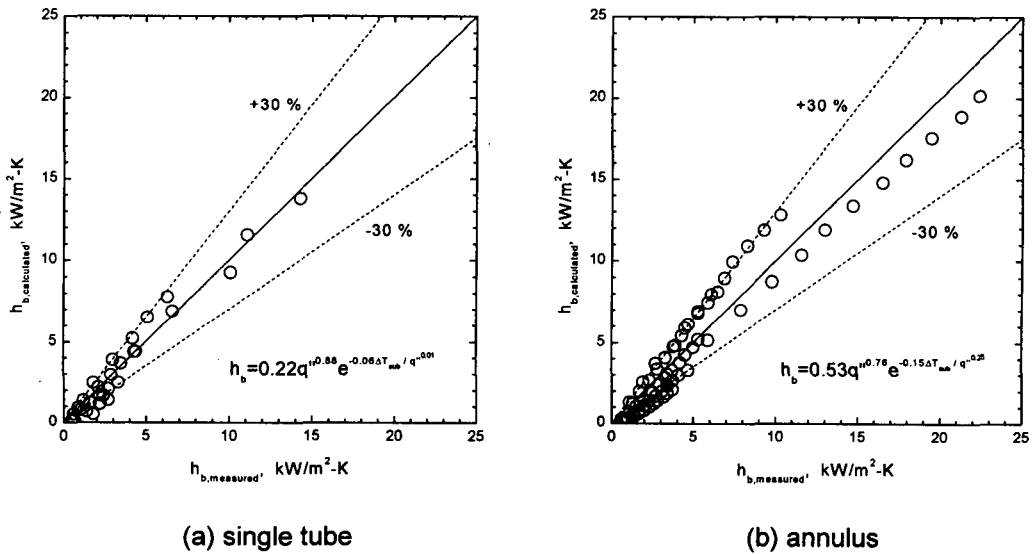

Fig. 12. Comparison of the Measured Heat Transfer Coefficients with Calculated Ones

smaller at the annulus, the intensity of liquid agitation condensed near the tube surface and this tendency results in a greater increase in the heat transfer coefficient at the annulus relative to the single tube.

To compare the present results with those of Judd et al. [8], ΔT_{sat} versus ΔT_{sub} curves are shown in Fig. 11. This kind of graphs is useful to predict temperatures of the heating surface. If the degree of liquid subcooling in a water storage tank

is known, we can predict the fluid temperature in the tube after some simple calculations. This is very important for the initial operating stage of a passive safety system since the temperature of the primary side is directly related with the reactor integrity. The general tendencies observed in the present study are similar to those found by Judd et al. [8]. However, the sudden increase in ΔT_{sat} at lower ΔT_{sub} is not observed clearly for the present results. The value of ΔT_{sat} is maintained nearly constant at $\Delta T_{sub} > 10$ °C. One of the possible explanations for the difference is the degree of superheating. In Judd et al. "results there was more than 10 °C superheating as the liquid was saturated. As the degree of superheating becomes higher, the value of the heat transfer coefficient becomes higher than that of the lower superheating case. Therefore, a sudden increase in the slope of ΔT_{sat} versus ΔT_{sub} curves is expected. In other words, as the degree of superheating is relatively lower, as in the present study, a sudden change in the slope is not expected since the difference between the heat transfer coefficients in saturated and near saturated liquids is not large.

To quantify the effects of subcooling on pool boiling heat transfer coefficients all experimental data were curve-fitted using the least square method, and the results are shown in Fig. 12. According to the results, the heat transfer coefficients for the single tube and the annulus can be correlated as $h_b = 0.22q^{0.88}e^{-0.06 \Delta T_{sub}/q^{0.01}}$ and $h_b = 0.53q^{0.76}e^{-0.15 \Delta T_{sub}/q^{0.25}}$, respectively. The calculated values predict the empirical data within $\pm 30\%$ error bound except some data at lower coefficients.

4. Conclusions

To identify the effects of liquid subcooling on pool boiling heat transfer of water at atmospheric pressure, an annulus with an open bottom in the

vertical direction has been studied experimentally. In addition, the results were compared with those of an unrestricted single tube and two empirical correlations were suggested. The major conclusions of the present study are as followings:

1. The slopes of the curves of heat flux versus average tube surface temperature for the annulus are much steeper than those of the single tube. Change in q'' from 10 to 110 kW/m² results in a 19.0% increase in T_w for the single tube while only an 11.8 % change in T_w is observed at the annulus.
2. The heat transfer coefficient increased as subcooling decreased regardless of the tube conditions. The rate of increase in the heat transfer coefficient was larger for the annulus. At $q'' = 70$ kW/m², as ΔT_{sub} decreases from 50 to 0 °C, 461 % (from 1.8 to 10.1 kW/m²-°C) and 539 % (from 2.3 to 14.7 kW/m²-°C) increases in heat transfer coefficients are observed at for the single tube and the annulus, respectively. The major heat transfer mechanisms are suggested as single-phase heat transfer and liquid agitation at $\Delta T_{sub} > 10$ °C and $\Delta T_{sub} \leq 10$ °C, respectively.
3. To obtain effects of subcooling on heat transfer quantitatively, new empirical equations of $h_b = 0.22q^{0.88}e^{-0.06 \Delta T_{sub}/q^{0.01}}$ and $h_b = 0.53q^{0.76}e^{-0.15 \Delta T_{sub}/q^{0.25}}$ are suggested for the single tube and the annulus, respectively, and the correlations predict the empirical data within $\pm 30\%$ error bound.

Nomenclature

A	heat transfer area
D	heating tube diameter
Di	inside diameter of the outer tube in annular tubes
h_b	average boiling heat transfer coefficient
I	supplied current
L	tube length

q	input power
q'	heat flux
t	time
T_b	bulk temperature in the annulus
T_{sat}	saturation temperature
T_w	tube wall temperature
T_{wat}	water temperature
V	supplied voltage
ΔT_{sat}	tube wall superheating ($=T_w - T_{sat}$)
ΔT_{sub}	liquid subcooling ($=T_{sat} - T_{wat}$)

Acknowledgments

This work was supported by the academic research support program of Andong National University.

References

- M.H. Chun and M.G. Kang, "Affects of Heat Exchanger Tube Parameters on Nucleate Pool Boiling Heat Transfer" ASME Journal of Heat Transfer 120, 468 (1998).
- M.M. Corletti and L.E. Hochreiter, "Advanced Light Water Reactor Passive Residual Heat Removal Heat Exchanger Test" Proceedings of the 1st JSME/ASME Joint International Conference on Nuclear Engineering, Tokyo, Japan, 381 (1991).
- M.G. Kang, "Experimental Investigation of Tube Length Effect on Nucleate Pool Boiling Heat Transfer," *Annals of Nuclear Energy*, 25, 295 (1998).
- S.M. Sloan, Code Assessment Studies of RELAP in Support of AP600 Thermal-hydraulic Analysis, Proceedings of the Fifth International Topical Meeting on Reactor Thermal Hydraulics, NURETH-5, UT, USA, Vol. 1, 151 (1992).
- EPRI ALWR URD, Vol. III : Utility Requirements for Passive Plant, 1990.
- T. van de Venne, "Applications of Passive Safety Systems to Large PWRs," Proceedings of the ANP 92, Tokyo, Paper No. 17.4 (1992).
- M.G. Kang, "Thermal Mixing in a Water Tank during Heating Process," *International Journal of Heat and Mass Transfer* 45, 4361 (2002).
- R.L. Judd, H. Merte, and M.E. Jr. Ulucakli, "Variation of Superheat with Subcooling in Nucleate Pool Boiling," *ASME J. Heat Transfer* 113, 201 (1991).
- W.S. Bradfield, "On the Effects of Subcooling on Wall Superheat in Pool Boiling," *ASME J. Heat Transfer* 89, 269 (1967).
- G.P. Celata, M. Cumo, and T. Setaro, T., "A Review of Pool and Forced Convective Boiling of Binary Mixtures," *Experimental Thermal and Fluid Science* 9, 367 (1994).
- P. Carrica, P.D. Marco, and W. Grassi, "Nucleate Pool Boiling in the Presence of an Electric Field: Effect of Subcooling and Heat-up Rate," *Experimental Thermal and Fluid Science* 15, 213 (1997).
- T. Inoue, N. Kawae, and M. Monde, "Effect of Subcooling on Critical Heat Flux during Pool Boiling on a Horizontal Heated Wire," *Heat and Mass Transfer* 33, 481 (1998).
- D.J. Lee, "Two-mode Boiling on a Horizontal Heating Wire: Effects of Liquid Subcoolings," *International Journal of Heat and Mass Transfer* 41, 2925 (1998).
- K. Cornwell, and S.D. Houston, "Nucleate Pool Boiling on Horizontal Tubes: a Convection-based Correlation," *International Journal of Heat and Mass Transfer* 37 (Suppl. 1), 303 (1994).
- K.E. Gungor and H.S. Winterton, "A General Correlation for Flow Boiling in Tubes and Annuli," *International Journal of Heat and Mass Transfer* 29 (3), 351 (1986).

16. Liu, Z. and R.H.S. Winterton, "A General Correlation for Saturated and Subcooled Flow Boiling in Tubes and Annuli, Based on a Nucleate Pool Boiling Equation," *International Journal of Heat and Mass Transfer* 34 (11), 2759 (1991).
17. Sun and G.F. Hewitt, "Experimental Studies on Heat Transfer in Annular Flow," *Proceedings of the 2nd European Thermal-Sciences and 14th UIT National Heat Transfer Conference*, 1345 (1996).
18. S.C. Yao and Y. Chang, "Pool Boiling Heat Transfer in a Confined Space," *International Journal of Heat and Mass Transfer* 26 (6), 841 (1983).
19. Y.H. Hung and S.C. Yao, "Pool Boiling Heat Transfer in Narrow Horizontal Annular Crevices," *ASME Journal of Heat Transfer* 107, 656 (1985).
20. J. Bonjour and M. Lallemand, "Flow Patterns during Boiling in a Narrow space between Two Vertical Surfaces," *International Journal of Multiphase Flow* 24, 947 (1998).
21. Y. Fujita, H. Ohta, S. Uchida, and K. Nishikawa, "Nucleate Boiling Heat Transfer and Critical Heat Flux in Narrow Space between Rectangular Spaces," *International Journal of Heat and Mass Transfer* 31 (2), 229 (1988).
22. M.G. Kang, "Pool Boiling Heat Transfer in Vertical Annular Crevices," *International Journal of Heat and Mass Transfer* 45 (15), 3245 (2002).