

JPE 3-3-2

Performance Improvement of an Active Neutral Harmonic Suppressor System Under Unbalanced Load Conditions

Sewan Choi* and Minsoo Jang

Dept. of Control and Instrumentation Eng., Seoul National University of Tech., Seoul, Korea

ABSTRACT

Three-phase four-wire electrical distribution systems are widely employed in manufacturing plants, commercial and residential buildings. Due to the nonlinear loads connected to the distribution system, the neutral conductor carries excessive harmonic currents even under balanced loading since the triplen harmonics in phase currents do not cancel each other. This may result in wiring failure of the neutral conductor and overloading of the distribution transformer. In response to these concerns, a cost-effective neutral current harmonic suppressor system has been proposed^[6].

This paper proposes an improved control method for the harmonic suppressor system under unbalanced load conditions. The proposed control method compensates for only the harmonic components in the neutral conductor, and the zero-sequence fundamental component due to unbalanced loading is prevented from flowing through the harmonic suppressor system. This remedies overloading and power loss of the system. The experimental results on a prototype validate the proposed control approach.

Keywords: Active filter, Neutral current, Three-phase four-wire, Zero-sequence harmonics

1. Introduction

Low voltage three-phase four-wire electrical distribution systems have been widely employed to deliver electric power to single-phase and/or three-phase loads in manufacturing plants, commercial and residential buildings. The most common loads connected to the distribution system are nonlinear and include computer systems, UPS, adjustable speed heating ventilation and air-conditioning systems, electronic and magnetic ballasts and photocopiers, etc. al. Nonlinear loads result in

significant neutral current in the three-phase four-wire system since triplen-odd harmonics in phase currents do not cancel each other even under balanced condition and are added up in the neutral line. In many cases, the neutral current exceeds the phase current. Under the worst case, the neutral current could be 1.73 times the phase current^[1].

Excessive neutral currents could cause wiring failure of the neutral conductor, overloading of the distribution transformer and a voltage drop between the neutral and the ground^[2]. Several methods have been proposed to reduce the neutral current harmonics^[3-6]. A passive zigzag transformer arrangement which is shunt connected to the load has a low zero-sequence impedance allowing zero-sequence currents to circulate from the neutral back to the loads^[3]. However, the effectiveness of the method is

Manuscript received April 21, 2003; revised June 26, 2003.

Corresponding Author: schoi@snut.ac.kr Tel: +82-2-970-6542, Fax: +82-2-949-2654

strongly dependent upon the system impedance which is usually unknown, and the reduction rate is not satisfactory. Three-phase four-wire active power filters employing a four-leg inverter or three single-phase inverters demonstrate superior compensation characteristics, but the schemes are complicated in control and high in cost^{[4][5]}.

A cost-effective active harmonic suppressor system employing a single-phase inverter along with a Δ -Y transformer has been proposed to reduce the neutral current harmonics^[6]. This scheme does not need special design of the transformer for low zero-sequence impedance unlike the passive zigzag transformer arrangement proposed in the literature^[3], and therefore the magnetic could be smaller in size and weight. The effectiveness of the scheme does not depend upon the system impedance, and reduction rate is over 90% in most cases. However, under unbalanced loading, the zero-sequence component of the fundamental load current can flow through the harmonic suppressor system. This may cause overloading of the harmonic suppressor system which is usually sized for zero-sequence harmonics and power loss due to unequal fundamental currents between the source and the load.

In this paper, the problem of the control method provided in the literature^[6] under unbalanced loading is addressed and an improved control method is proposed. With the proposed control method, overloading and power loss of the active filter are remedied since only the harmonic currents pass through the active filter while the *fundamental current remains unaffected*.

2. Proposed Analysis and Control Method

2.1 Neutral Current Under Unbalanced Load Condition

In three-phase four-wire systems, neutral current is the algebraic sum of three phase currents. Three phase currents with balanced and linear loads sum to zero, thus there is no neutral current in this case. Nonlinear loads such as power supplies and rectifiers have phase currents that are not sinusoidal. The algebraic sum of three balanced and non-sinusoidal phase currents does not sum to zero, as shown in Fig. 1(a). Especially, the zero-sequence odd-triplen harmonics (3rd, 9th, 15th...) do

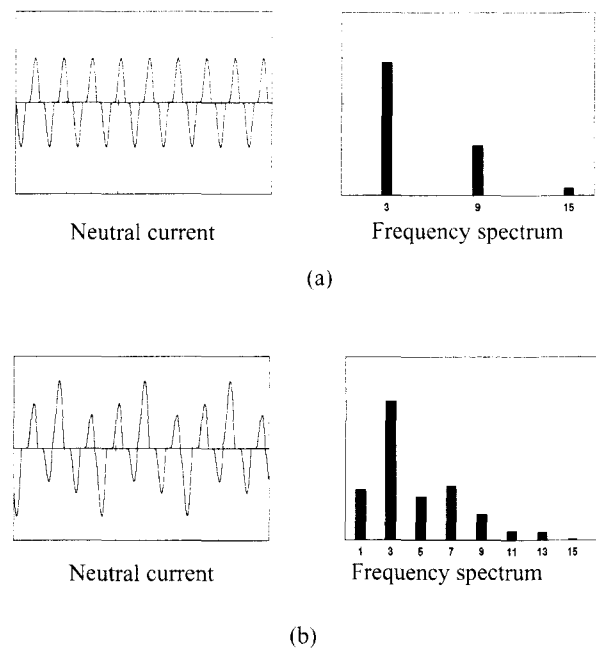

Fig. 1. Neutral current waveform: (a) balanced load condition and (b) unbalanced load condition.

not cancel each other in the neutral conductor, thus resulting in excessive neutral current.

In the meanwhile, neutral current resulting from unbalanced and nonlinear loads consists of not only the harmonic zero-sequence components but the fundamental zero-sequence component which should remain unaffected. Fig. 1(b) shows a typical neutral current waveform and its frequency spectrum under 26.8% of unbalance factor.

The voltage unbalance factor (*UBF*) defined in European standards^[7] is used in this paper as an index of degree of unbalance. In percentage value, it is expressed as,

$$UBF = \frac{\text{Negative Sequence Magnitude}}{\text{Positive Sequence Magnitude}} \times 100 (\%) \quad (1)$$

2.2 Conventional Control Method

Fig. 2 shows the power circuit of the active neutral current harmonic suppressor system proposed in^[6]. The Y-connected primary provides a neutral point, and the Δ -connected secondary provides a path for zero-sequence currents to circulate and supplies a three-phase diode

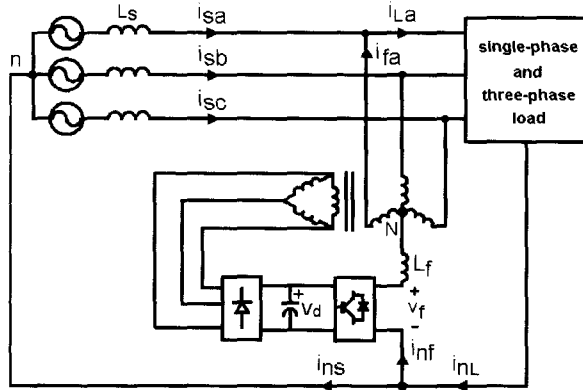

Fig. 2. Active neutral harmonic suppressor system.

rectifier that provides a small amount of power required to maintain the dc voltage across the capacitor.

The block diagram of the closed loop control system is shown in Fig. 3(a). The source-side neutral current i_{ns} is sensed, passed through a 60Hz notch filter in order to remove fundamental component, and then compared with the reference current i_{ns}^* which is set to zero as the desired neutral current is zero. The transfer function $G(s)$ of the 60Hz notch filter is assumed to be,

$$G(s) = \frac{s^2 + \omega_0^2}{s^2 + \frac{\omega_0}{Q}s + \omega_0^2} \quad (2)$$

where ω_0 is the angular notch frequency tuned at 60Hz and Q is the quality factor.

The error signal is amplified in the controller gain stage, and then the resulting control signal v_c is compared with a high frequency triangular signal to get the gating command for the inverter switches. Assuming that the peak amplitude of the triangular signal is A_T and the inverter dc voltage is V_d , the gain of the power switching block can be expressed as^[6],

$$K_{AMP} = \frac{V_d}{A_T} \quad (3)$$

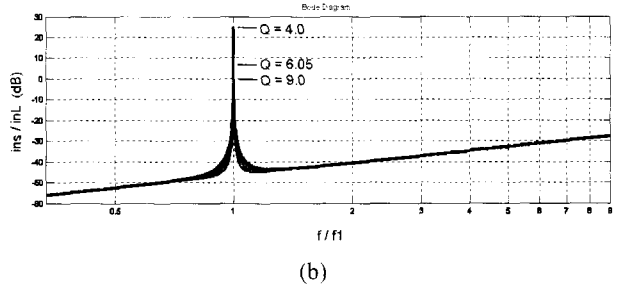
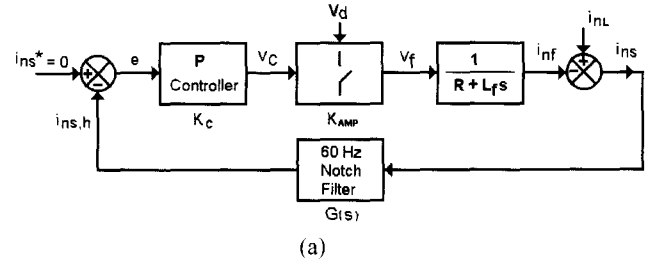

Fig. 3. Block diagram and compensation characteristics of the conventional control method: (a) block diagram of the closed loop control system and (b) compensation characteristics.

The inductor L_f is selected to filter the switching ripple caused by the *PWM* operation of the inverter switches. Then, the closed loop transfer function between the source-side neutral current i_{ns} and the load-side neutral current i_{nL} is expressed in equation (4).

Fig. 3(b) shows the compensation characteristics of the active filter in case of $Q = 4.0$, $Q = 6.05$ and $Q = 9.0$, respectively. With the quality factor smaller than 9.0, the fundamental component can be amplified in the source side neutral, which is undesirable. The pass band is so narrow that a small variation on the fundamental frequency may cause severe attenuation of not only the harmonic components but the fundamental component in the source-side neutral current. Further, the compensation characteristics of the neutral current are not influenced by the quality factor. This illustrates that the fundamental zero-sequence current resulting from unbalanced loading can flow through the active filter and may cause power

$$\frac{i_{ns}(s)}{i_{nL}(s)} = \frac{s^3 + \left(\frac{R}{L_f} + \frac{\omega_0}{Q}\right)s^2 + \left(\frac{R}{L_f} \frac{\omega_0}{Q} + \omega_0\right)s + \frac{R}{L_f} \omega_0^2}{s^3 + \left(\frac{R}{L_f} + \frac{\omega_0}{Q} - \frac{K_c \cdot K_{AMP}}{L_f}\right)s^2 + \left(\frac{1}{L_f} \frac{\omega_0}{Q} + \omega_0^2\right)s + \left(\frac{R}{L_f} - \frac{K_c \cdot K_{AMP}}{L_f}\right)\omega_0^2} \quad (4)$$

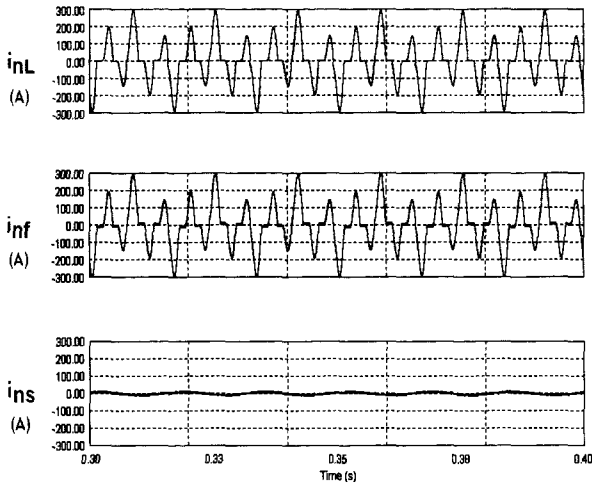

Fig. 4. Simulated waveforms of the conventional control method.

loss and overloading of the harmonic suppressor system which is usually sized for zero-sequence harmonics.

Fig. 4 shows the simulated waveforms of the control method, illustrated in Fig. 3(a), with 26.8% of unbalanced loading. With the control method presented in Fig. 3(a), not only the harmonic components but the fundamental component in the load-side neutral current i_{nL} flows through the harmonic suppressor system, and therefore the source-side neutral current i_{ns} becomes nearly zero. This may cause overloading and power loss of the harmonic suppressor system.

2.3 Proposed Control Method

The block diagram illustrating the proposed control method is shown in Fig. 5(a). The load-side neutral current i_{nL} is sensed and passed through a 60Hz notch filter in order to remove fundamental component. The resulting neutral harmonic current $i_{nL,h}$ becomes the reference i_{nf}^* for current control of the inverter. The actual inverter output current i_{nf} is sensed and compared with the reference current i_{nf}^* .

The remaining part of the block diagram is identical to the conventional one. Then, the closed loop transfer function between the source-side neutral current i_{ns} and the load-side neutral current i_{nL} is expressed in equation (5).

Fig. 5(b) shows the compensation characteristics of the harmonic suppressor system in case of $Q = 4.0$, $Q = 6.05$ and $Q = 9.0$, respectively. As the quality factor Q increases, the pass band becomes narrow. For any quality factor Q , only the fundamental component of the load-side neutral current could flow through the source side while the harmonic components are blocked from flowing into the source-side neutral conductor. The proposed control extracts only the harmonic currents from the load-side neutral line and has them pass through the harmonic suppressor system while the fundamental current remains unaffected and flows through the source-side neutral conductor.

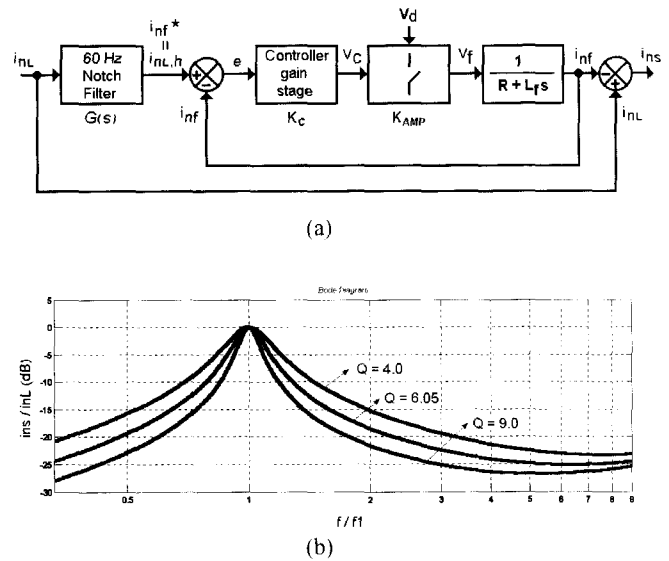

Fig. 5. Block diagram and compensation characteristics of the proposed control method: (a) block diagram of the closed loop control system and (b) compensation characteristics.

$$\frac{i_{ns}(s)}{i_{nL}(s)} = \frac{s^3 + \frac{R}{L_f}s^2 + \left(\frac{R}{L_f} \frac{\omega_0}{Q} + \frac{K_C \cdot K_{AMP}}{L_f} \frac{\omega_0}{Q} + \omega_0^2 \right) s + \frac{R}{L_f} \omega_0^2}{s^3 + \left(\frac{R}{L_f} + \frac{K_C \cdot K_{AMP}}{L_f} \right) s^2 + \left(\frac{R}{L_f} \frac{\omega_0}{Q} + \frac{K_C \cdot K_{AMP}}{L_f} \frac{\omega_0}{Q} + \omega_0^2 \right) s + \left(\frac{R}{L_f} - \frac{K_C \cdot K_{AMP}}{L_f} \right) \omega_0^2} \quad (5)$$

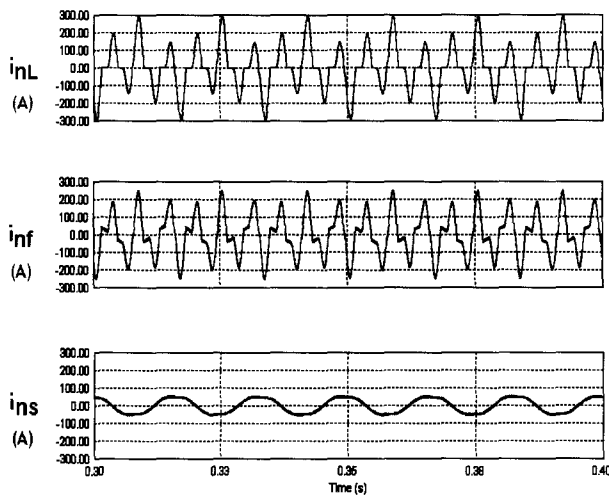

Fig. 6. Simulated waveforms of the proposed control method.

Fig. 6 shows the simulated waveforms of the proposed control method illustrated in Fig. 5(a). With the proposed control method, only the harmonic currents $i_{nL,h}$ in the load-side neutral conductor flow through the active filter and the zero-sequence fundamental current is prevented from flowing into the harmonic suppressor system, thus passing the current through the source. This prevents the harmonic suppressor system from being overloaded and causing power loss.

2.4 KVA Rating of the Harmonic Suppressor System

The KVA rating of the Δ -Y transformer is calculated by considering the product of the rms voltage and the rms current associated with each of its windings. The KVA rating of the inverter switches is calculated as the product of the peak current and peak voltage. The dc bus voltage is determined to be two to three times the peak voltage between the transformer neutral 'N' and the utility ground 'n', where it takes into account the voltage drop across the leakage inductance of the transformer. In this calculation, the voltage rating is assumed to be identical for all of the cases.

Table 1 shows some typical values of the many possible combinations of the load phase currents assuming that the loads are three single-phase rectifiers with capacitive filter and resistive load. Sums of the three fundamental load phase currents are kept constant to illustrate equal load KVA ratings for each of the cases.

Table 1. Fundamental load phase currents for specified unbalanced factors.

UBF	$I_{La,l}$	$I_{Lb,l}$	$I_{Lc,l}$
Balanced	$1\angle 0$	$1\angle -120$	$1\angle 120$
10%	$1\angle 0$	$0.83\angle -120$	$1.17\angle 120$
20%	$1\angle 0$	$0.65\angle -120$	$1.35\angle 120$
30%	$1\angle 0$	$0.48\angle -120$	$1.52\angle 120$
40%	$1\angle 0$	$0.31\angle -120$	$1.69\angle 120$
50%	$1\angle 0$	$0.13\angle -120$	$1.87\angle 120$

Table 2. Required KVA rating of the harmonic suppressor system (in per unit).

UBF	Conventional system		Proposed system	
	Transformer (pu)	Inverter (pu)	Transformer (pu)	Inverter (pu)
Balance	1.0	1.0	1.0	1.0
10%	1.02	1.12	0.99	1.06
20%	1.05	1.25	0.97	1.13
30%	1.11	1.37	0.94	1.17
40%	1.19	1.50	0.89	1.18
50%	1.32	1.66	0.85	1.18

The comparative results are shown in Table 2, where the KVA ratings of the inverter and the transformer are normalized to be 1 pu with respect to balanced loadings. It is noted that the effectiveness of the proposed control method becomes significant as the degree of unbalance increases.

3. Experimental Results

A laboratory prototype of the active neutral harmonic suppressor system employing the proposed control method has been built and the experimental results are discussed in this section. The system parameters used in the experiment are given as follows:

- Supply: 220V(line-to-line, RMS), 60Hz, $L_s = 3\text{mH}$
- Loads: Three single-phase diode rectifiers with

capacitive filter and resistive load. $C_a = C_b = C_c = 3300\mu\text{F}$, $R_a = R_b = R_c = 300\Omega$ for balanced loading. $C_a = C_b = C_c = 3300\mu\text{F}$, $R_a = 110\Omega$, $R_b = 190\Omega$, $R_c = 300\Omega$ for unbalanced loading.

- Active Filter: Full-Bridge PWM inverter operated at switching frequency $f_{sw} = 20\text{kHz}$ with a filter inductor $L_f = 2\text{mH}$.

- Δ -Y transformer: Turn ratio of 1:1

3.1 Balanced Loading

Fig. 7 shows the experimental waveforms of each current under balanced loading. Since the rectifier loads are nonlinear even though they are balanced, the load-side neutral current i_{nL} becomes excessive and contains significant triplen harmonics such as 3rd, 9th, and 15th, etc.

The rms value of the load phase current $i_{L,a}$ is 1.42A, but the neutral current i_{nL} is 2.36A which is 1.66 times the phase current. The source-side neutral current i_{ns} becomes nearly zero since the zero-sequence triplen harmonics in the load-side neutral conductor flow through the active filter and do not appear in the source-side neutral conductor. In this case the active filter output current i_{nf} is almost the same as the load-side neutral current i_{nL} .

In the meanwhile, the THD of the load phase current $i_{L,a}$ is 75.9%. The THD of the source current is reduced to 28.7% since the zero-sequence triplen harmonics injected into the Δ -Y transformer cancel the zero-sequence triplen harmonic in the load phase current as well. It can be seen from the FFT of the source current i_{sa} that all the triplen harmonics are suppressed in the source.

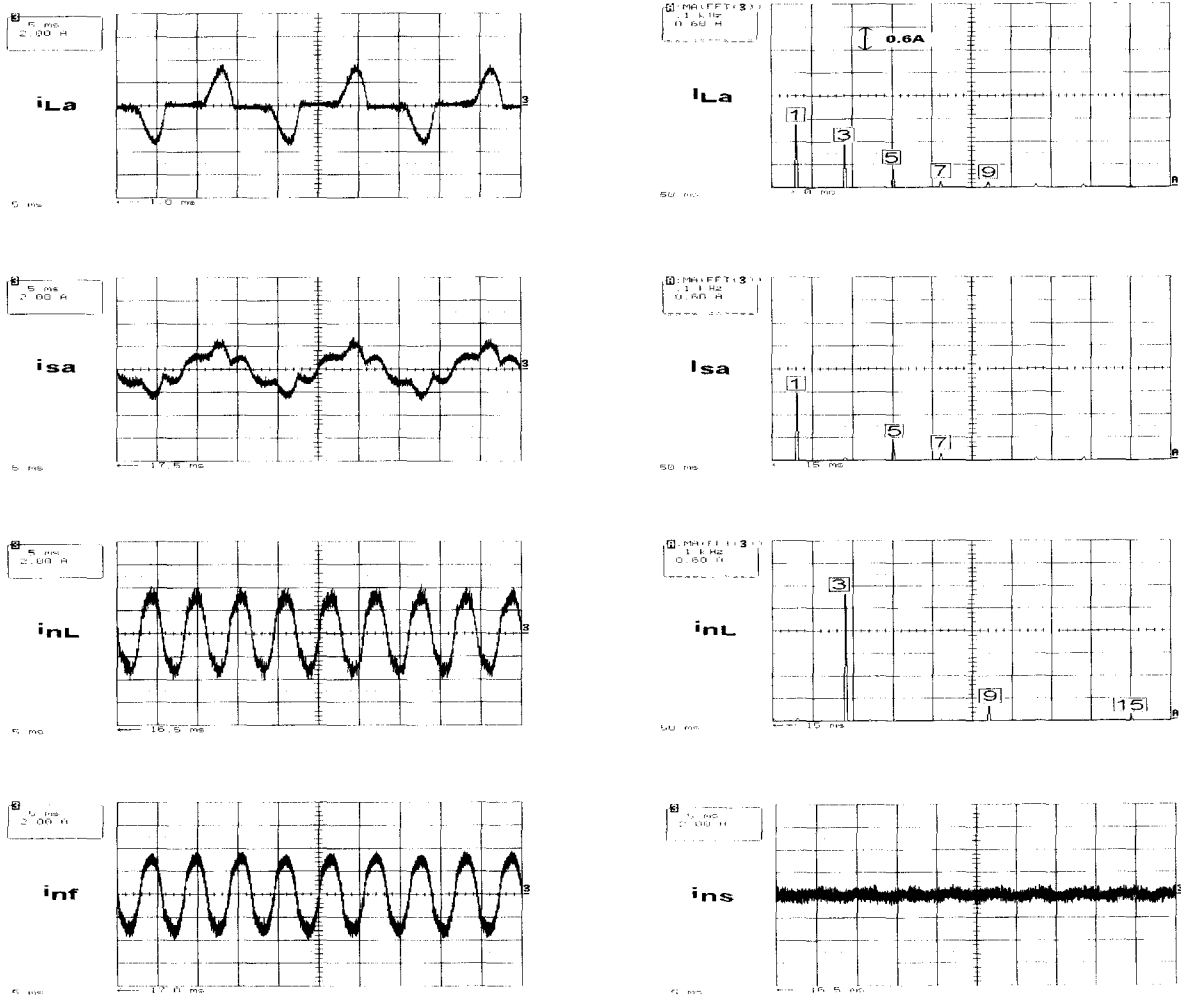

Fig. 7. Experimental waveforms and frequency spectra under balanced loading (2A/div, 5ms/div).

3.2 Unbalanced Loading

The experimental waveforms of each current under

unbalanced loading are shown in Fig. 8. With 22% of the unbalanced factor, the rms values of the load phase

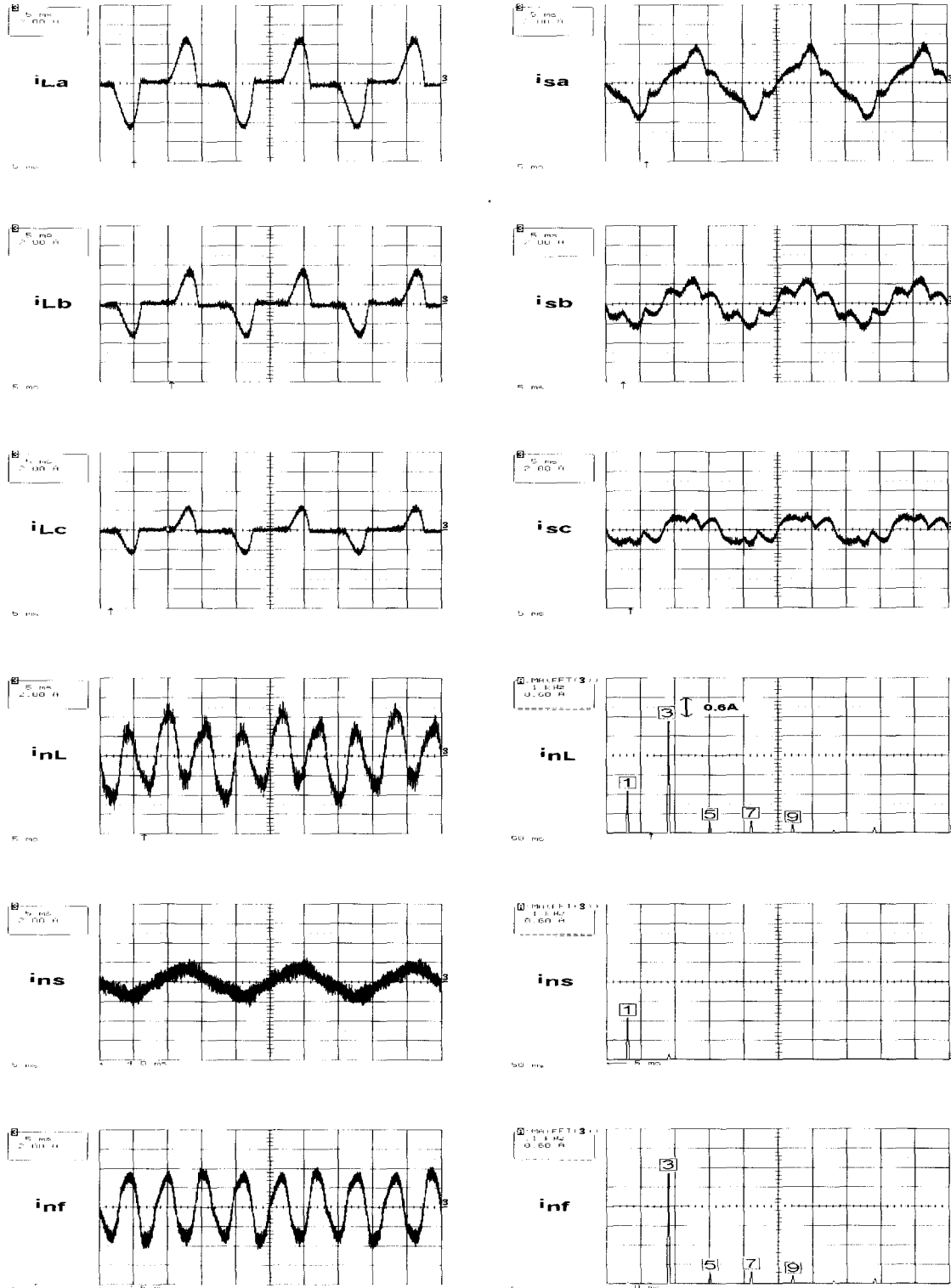

Fig. 8. Experimental waveforms and frequency spectra under unbalanced loading (2A/div, 5ms/div).

currents i_{La} , i_{Lb} , and i_{Lc} are 2.13A, 1.46A, and 0.98A, respectively. The load-side neutral current i_{nL} is 2.6A and contains not only the harmonic zero-sequence components but the fundamental zero-sequence component due to the unbalanced loading among the phases as shown in the FFT of i_{nL} . The active filter extracts only the zero-sequence harmonics from the load-side neutral current and has them flow back to the load phase. Therefore, the zero-sequence fundamental component of i_{nL} caused by unbalanced loading passes through the source and is not affected by the harmonic suppression system.

The THDs of the load phase currents i_{La} , i_{Lb} , and i_{Lc} are 66.4%, 76.5%, and 86.2%, respectively. The THDs of the source currents i_{sa} , i_{sb} , and i_{sc} are reduced to 25.3%, 32.3%, and 51.4%, respectively.

4. Conclusions

In this paper, a modified control method for the harmonic suppression system is proposed to improve compensation characteristics under unbalanced load conditions. The proposed control method prevents the zero-sequence fundamental component due to unbalanced loading from flowing through the harmonic suppression system. Therefore, the fundamental component remains unaffected. This overloading and power loss of the system.

The THDs of the phase currents are also reduced since the zero-sequence triplen harmonics injected into the Δ -Y transformer cancel the zero-sequence triplen harmonic in the load phase current as well. The experimental results on a prototype validate the proposed control approach.

Acknowledgement

This work was supported by the research fund of Seoul National University of Technology.

References

- [1] T.M. Gruz, "Power System Problems from High Harmonic Neutral Current", Computer Tech. Rev., winter 1988.
- [2] T.M. Gruz, "A Survey of Neutral Current in Three-Phase Computer Power System", IEEE Trans. on Ind. Appl. Vol. 26, No. 4, pp. 719-725, Jul/Aug. 1990.
- [3] Prem P. Khera, "Application of Zigzag Transformers for Reducing Harmonics in the Neutral Conductor of Low Voltage Distribution System", IEEE IAS Conf. Rec., 1990.
- [4] C.A. Quinn and N. Mohan, "Active Filtering of Harmonic Currents in Three-Phase, Four-Wire Systems with Three-Phase and Single-Phase Non-Linear Loads", APEC 1992, pp. 829-835.
- [5] B. Singh, K. Al-Haddad, and A. Chandra, "Active Power Filter for Harmonic and Reactive Power Compensation in Three-Phase, Four-Wire Systems Supplying Non-Linear Loads", ETEP, Vol. 8, No. 2, pp.139-145, March/April.
- [6] P.N. Enjeti and W. Shiren, "Analysis and Design of a New Active Power Filter to Cancel Neutral Current Harmonics in Three-Phase Four-Wire Electric Distribution Systems", IEEE Trans. Ind. Appl., Vol. 30, No. 6, pp. 1565-1572, Nov./Dec. 1994.
- [7] J. Reeve and P.C. S. Krishnayya, "Unusual current harmonics arising from high voltage DC transmission", IEEE Trans. Power App. System, Vol. PAS-87, No. 3, pp. 883-893, Mar. 1968.

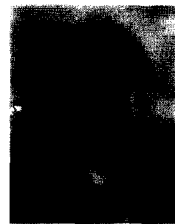

Sewan Choi received the B.S. degree in Electronic Eng. from Inha Univ., Incheon, Korea, in 1985 and the M.S. and Ph.D. degrees in Electrical Eng. from Texas A&M Univ., College Station, TX, in 1992 and 1995, respectively. From 1985 to 1990, he was with Daewoo Heavy Industries as a Research Engineer. From 1996 to 1997, he was a Principal Research Engineer at Samsung Electro-Mechanics Co., Korea. In 1997, he joined the Dept. of Control and Instrumentation Eng., Seoul National University of Technology, Seoul, Korea, where he is currently an Associate Professor. Dr. Choi is an Associate Editor of Journal of Power Electronics and KIEE Trans. on Electric Machines and Energy Conversion Systems. His research interests include utility interface and power quality issues including three-phase power factor correction and power conversion technologies in renewable energy systems.

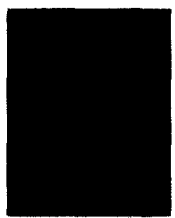

Minsoo Jang was born in Seoul, Korea, on June 11, 1976. He received the B.S. degree in Dept. of Control and Instrumentation Engineering in 2001 from Seoul National University of Technology in Seoul, Korea.

He is currently pursuing the M.S. degree in Power Electronics at SNUT. His work at SNUT involves Active power filter, UPS, Fuel Cell Inverter and DSP control.