

Modified Similitude Law for Pseudodynamic Test on Small-scale Steel Models

철골 축소모형의 유사동적실험을 위한 수정된 상사법칙

김 남 식* 광 영 학** 장 승 필***
Kim, Nam-Sik Kwak, Young-Hak Chang, Sung-Pil

국문요약

지진하중에 대한 구조물의 동적 거동과 내진성능을 평가하기 위하여 유사동적실험기법이 흔히 사용되고 있으나, 실험장비의 제약과 구조물의 규모 등으로 대부분 축소모형실험에 의존하고 있다. 그러나 일반적인 상사법칙은 탄성범위에서 유도된 것으로 지진거동과 같은 비탄성 거동을 예측하는 경우에는 한계가 있기 때문에 축소 모형의 실험결과를 원형 구조물에 직접 적용하는 것은 많은 주의가 필요하다. 본 연구에서는 원형구조물과 축소모형에 대한 철골모형을 실험 대상으로 하여 실제 축소 모형 실험결과로부터 원형구조물의 거동을 예측하는 경우의 문제점을 확인하고, 그 해결방법을 모색하고자 한다. 실제로 축소모형실험에서는 원형구조물의 경계조건을 정확히 재현하기 어려우며, 축소모형의 제작과정과 실험과정에서의 모든 오차가 강성의 변화로 반영되어 나타난다. 따라서 본 연구에서는 기하학적 상사율과 축소 모형의 변화된 강성비를 함께 고려한 수정된 상사법칙을 제안하였으며, 수정된 상사법칙이 적용된 축소모형에 대하여 유사동적실험을 수행하여 지진응답결과를 원형 구조물의 결과와 비교 하였다. 축소모형에 대한 유사동적실험결과로부터 제안된 상사법칙을 적용함으로써 원형구조물의 지진응답 재현이 효과적임을 입증하였다.

주요어 : 상사법칙, 원형구조물, 축소모형, 강성비, 유사동적실험, 수정된 상사법칙

ABSTRACT

Although there are several experimental techniques to evaluate the seismic behavior and performance of civil structures, small-scale models in most of physical tests, instead of prototypes or large-scale models, would be used due to a limitation on capacities of testing equipments. However, the inelastic seismic response prediction of small-scale models has some discrepancies inherently because the similitude law is generally derived in the elastic range. Thus, a special attention is required to regard the seismic behavior of small-scale models as one of prototypes. In this paper, differences between prototypes and small-scale models pseudodynamically tested on steel column specimens are investigated and an alternative to minimize them is suggested. In general, small-scale models could have the distorted stiffness induced from some experimental errors on test setup, steel fabrication and so on. Therefore, a modified similitude law considering both a scale factor for length and a stiffness ratio of small-scale model to prototype is proposed. Using the modified similitude law to compensate experimental errors, the pseudodynamic test results from modified small-scale model are much improved as compared with the results of prototype. According to the pseudodynamic test results of small-scale steel models, it can be concluded that the modified similitude law proposed could be effective in simulating the seismic response of prototype structures.

Key words : similitude law, prototype structure, small-scale model, stiffness ratio, pseudodynamic test, modified similitude law

1. Introduction

Although there are several experimental techniques to evaluate the seismic behavior and performance of structures, small-scale models would be used due to a limitation on testing facilities or economic reasons in most of physical tests. The prediction of inelastic behavior under an earthquake loading condition has some discrepancies inherently because the similitude law is generally derived in the elastic range. Moreover size effect on small-scale models exists even in the elastic range. The evidence points to influence of size effect in steel beams was presented by Richards.⁽¹⁾ Thus, a special attention is required to regard the behavior of small-scale models as one of prototypes. In general, similitude

law including geometric concept is the basis of performing small-scale model tests. However, due to the discrepancy between small-scale model and prototype, it is basically influenced with the evaluation and application of experimental results obtained from small-scale models. By reason of the problems, Zhang, et al.^{(2),(3)} developed a new similitude law adaptable to seismic simulation tests on small-scale models and Meng⁽⁴⁾ made use of microconcrete material for small-scale model tests. As previous researchers, Kim, et al.⁽⁵⁾ and Lu, et al.⁽⁶⁾ had some efforts on investigating reinforced concrete scaled models.

In physical experiments, it is difficult to simulate precisely the boundary conditions of a prototype by using a small-scale model, due to the errors induced from test specimens. Also, mechanical properties and experimental conditions could be different from each other. Nevertheless, a small-scale model should satisfy the similitude relationship of a prototype and reflect significant properties on test results.

* 정회원 · 현대건설기술연구소, 책임연구원(대표저자 : nskim@hdec.co.kr)

** (주)유신코퍼레이션 · 구조1부, 대리

*** 정회원 · 서울대학교 지구환경시스템공학부, 교수

본 논문에 대한 토의를 2003년 2월 28일까지 학회로 보내 주시면 그 결과를 게재하겠습니다.
(논문접수일 : 2003. 8. 26 / 심사종료일 : 2003. 12. 5)

Consequently satisfying the similitude law, small-scale model tests could be reliable to predict the seismic performance of prototypes. In general, geometric similitude law in the elastic range would be used for the small-scale model tests. Thus, establishment of a similitude law considering inelastic behaviors and experimental errors may be an outstanding tool of the small-scale model tests for exactly evaluating the seismic performance of structures. To avoid the uncertainty of small-scale models, pseudodynamic tests on large-scale models have been applied by many researchers.⁽⁷⁾⁻⁽¹²⁾ By Kumar et al.⁽⁹⁾, two choices corresponding to the selection of a convenient scale factor for mass or time, respectively, were examined for the pseudodynamic tests.

In this study, consistency of three similitude laws based on mass, time or acceleration, respectively, are verified by the pseudodynamic tests on the scaled steel models which are under the same scale factors for: length and force. And a modified similitude law considering both a scale factor for length and a stiffness ratio is proposed. It can compensate experimental errors of the scaled steel models and the scaled model test results could be directly applied to prototypes.

2. General Similitude Law

Similitude law is generally applied to define a specimen for scaled model tests. A proper similitude law should be selected for satisfying a specific test objective or method. Typically in time-dependent loading problems, three independent scale factors, which represent three fundamental dimensions, namely, mass, length and time, need to be selected for designing the scaled models. Thus selecting three dimensions, other scale factors can be derived from the principles of dimensional analysis.⁽¹³⁾ Scale factors may be determined from consideration of the capacity of testing facilities in the scaled model tests. When the same materials on both a prototype and a scaled model are used, a scale factor for stress becomes unity. Thus, various derivatives can be obtained based on the selected dimensions. Considering an adequate added mass, three conventional similitude laws with the same material could be normally derived as shown in Table 1, in which a scale factor for length is as a basic dimension.

2.1 Mass-based law

When the effect on gravity loads plays an important role, it is convenient to select a scale factor for mass as S^3 . In this law, mass distribution of prototypes is accurately

Table 1 Conventional similitude laws

| Quantity | Dimension | Scale Factor | | |
|--------------|-----------------|----------------|----------------|------------------------|
| | | Mass-based law | Time-based law | Acceleration-based law |
| Length | L | S | S | S |
| Mass | M | S^3 | S | S^2 |
| Time | T | S | 1 | $S^{1/2}$ |
| Stress | $ML^{-1}T^{-2}$ | 1 | 1 | 1 |
| Velocity | LT^{-1} | 1 | S | $S^{1/2}$ |
| Acceleration | LT^{-2} | S^{-1} | S | 1 |
| Force | MLT^{-2} | S^2 | S^2 | S^2 |
| Stiffness | MT^{-2} | S | S | S |
| Damping | MT^{-1} | S^2 | S | $S^{3/4}$ |
| Frequency | T^{-1} | S^{-1} | 1 | $S^{-1/2}$ |

simulated in scaled models and there is no need to consider an added mass. However, a scale factor for time is defined as S . Such a compression of time would have complicated the test conditions. In particular, using a conventional dynamic testing method like shaking table tests, the limitation on shaking speed could be occurred. But pseudodynamic tests being carried out in a static manner may be satisfied with the mass-based similitude law.

2.2 Time-based law

If gravity loads can be negligible on evaluating the seismic performance of the scaled models, a scale factor for time can be chosen as a basic dimension. This law has been justified by stating that since the frequency effects are preserved, qualitative information can be obtained regarding the seismic performance of the structure subjected to the given earthquake.⁽⁹⁾ However, in the inelastic range, it should be realized that structural response could not be obtained exactly, since the forces are no longer proportional to the displacement. The time-base similitude law has been mainly applied to the pseudodynamic tests.^{(8)-(10),(12)} In case of the shaking table tests, an added mass is needed because a scale factor for mass is S .

2.3 Acceleration-based law

Although acceleration inputs as an artificial loading could be controlled, the acceleration of gravity is not controlled artificially. Thus, a scale factor for acceleration should be unity to simulate both gravity and inertia forces at the same time. In the acceleration-base similitude law, added

mass and compressed time are needed for performing the real-time dynamic tests because scale factors for mass and time correspond to S^2 and $S^{1/2}$, respectively. However, it is an ideal method for the pseudodynamic tests that deals with mass and time numerically assumed in a computer.

3. Preliminary Test

In this study, it is to verify the problems of scaled model tests and then search the feasible relationship between scaled model and prototype. Test specimens used are cantilevered steel columns and the dimensions of prototype are shown in Fig. 1. The specimens were fabricated of SS400 steel⁽¹⁴⁾ and the material properties determined from tensile coupon test⁽¹⁵⁾ are presented in Table 2. The scaled model was designed based on general similitude law of Table 1 and the detail dimensions and characteristics of prototype and scaled model are summarized in Table 3. Fig. 2 shows test setup for the specimens.

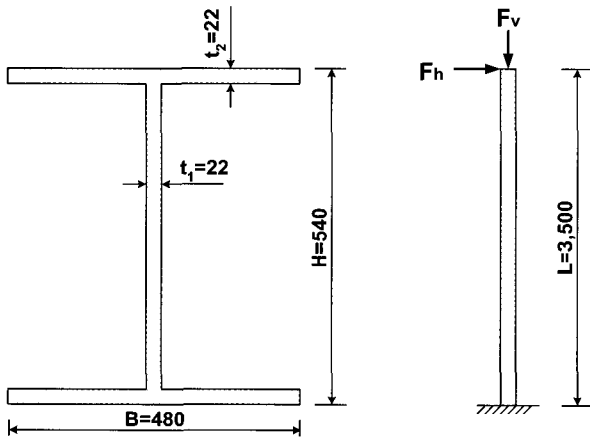

Fig. 1 Dimensions of specimen(prototype)

Table 2 Material properties of steel

| Coupon | E [GPa] | σ_y [MPa] | ϵ_y [%] |
|--------------|-----------|------------------|------------------|
| Prototype | 203 | 311 | 0.153 |
| Scaled Model | 196 | 324 | 0.165 |

Table 3 Dimensions and characteristics of specimens

| Item | Prototype | Scaled Model($S=3.79$) |
|--------------------------------|-----------------------|--------------------------|
| Height H [mm] | 540 | 142.36 |
| Width B [mm] | 480 | 126.55 |
| Thickness t [mm] | 22 | 5.8 |
| Length L [mm] | 3500 | 922.73 |
| Mass M [kg] | 77.67×10^3 | 5.40×10^3 |
| Stiffness K [N/m] | 23.66×10^6 | 6.24×10^6 |
| Frequency f [Hz] | 2.78 | 5.41 |
| Yield Force F_y [N] | 458.98×10^3 | 31.90×10^3 |
| Yielding Displ. δ_y [m] | 19.4×10^{-3} | 5.11×10^{-3} |

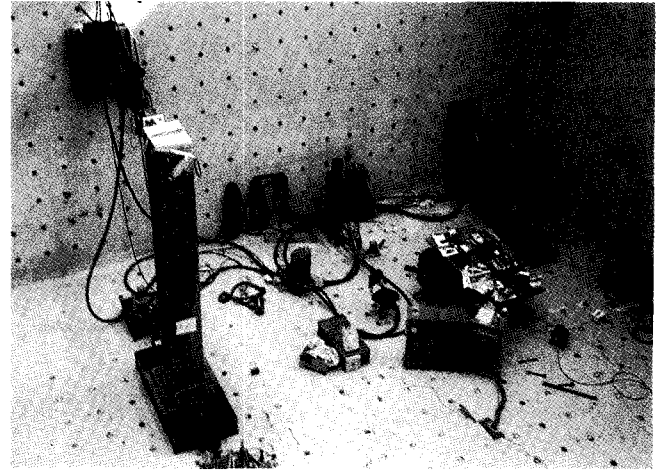

Fig. 2 Test setup for specimens

3.1 Quasistatic tests

At first, hysteretic behavior of the specimens was experimentally obtained from the quasistatic tests. In this study, a constant axial force corresponding to structural mass is applied to be 15% of the compressive strength of steel columns. Also, the cyclic loadings in displacement control are exerted to the specimens horizontally. In an initial stage up to $1.0\delta_y$, the number of cycles is only one in each step and the displacement increment is $0.25\delta_y$, where δ_y is the yield displacement of specimens. Beyond this stage, in each step three cycles with the displacement increment of $1.0\delta_y$ are applied up to $8.0\delta_y$. The quasistatic test results of the specimens are presented in Fig. 3.

Since the scaled model was designed with a length scale factor of 3.79, stiffness of the prototype could be expected to be 3.79 times higher than one of the scaled model. However, the stiffness values obtained experimentally from both the prototype and the scaled model appear as lower than the designed values. Moreover, stiffness decrease ratio of the prototype is higher than the scaled model. According to the test results, the actual stiffness ratio of prototype to scaled model is estimated as 3.07. It can be presumed that stiffness reduction is mainly reasoned by an excessive welding.

In most of the scaled model tests, only scale factor is generally considered to estimate the structural performance of prototype. Fig. 3 shows a comparison between the prototype test results and the estimated results from scaled model test using the designed scale factor($S=3.79$). According to Fig. 3, it is noticed that over-yield-strength is expected as estimating the response of prototype with the designed scale factor. However, it is not appropriate to compare because the stiffness of prototype and the estimated stiffness are not identical in the elastic range.

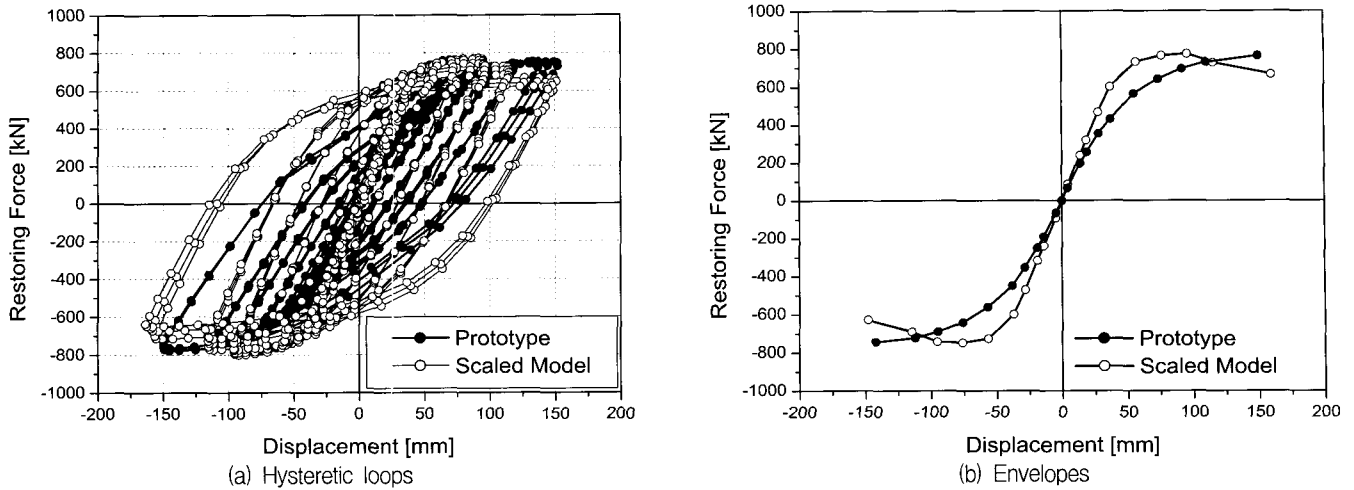

Fig. 3 Quasistatic test results of prototype and scaled model ($S=3.79$)

3.2 Observation of plastic hinge zone

The behavior of plastic hinge zone was observed by strain gauges during the quasistatic tests. Figs. 4 and 5 show the locations of strain gauges attached on the plastic hinge zone and their appearances. In this study, it can be assumed that plastic hinge zone is located within $1.5B$ high from a clamped end.

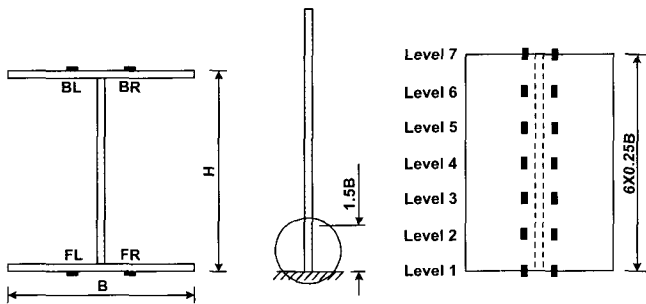
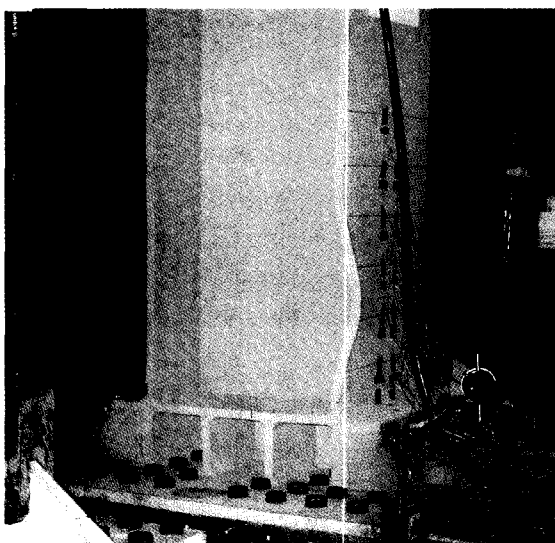

Fig. 4 Location of strain gauge levels

Both the prototype and the scaled model show nearly elastic behavior at strain gauge levels 6 and 7 throughout the whole quasistatic testing procedure. Thus, from this observation, it could be confirmed that assuming the plastic hinge zone to be $1.0B$ is appropriate, based on the measured strain variations along the strain gauge levels and the buckling location of test specimens.

Failure modes due to local buckling in flange are shown in Fig. 5. It can be inferred from comparison of the measured strain values that locations of local buckling observed from the prototype and the scaled model could be slightly different.

Stress-strain curves on strain gauge levels 5 and 6 at the location of FR side are plotted in Fig. 6. At each gauge level, the estimated stress can be calculated by using flexural moment derived from the measured forces. From the test results, yield strains are obtained near about 1500 microstrains, which is a little higher than nominal value of 1200 microstrains. The test results from other locations are almost similar



(a) Prototype

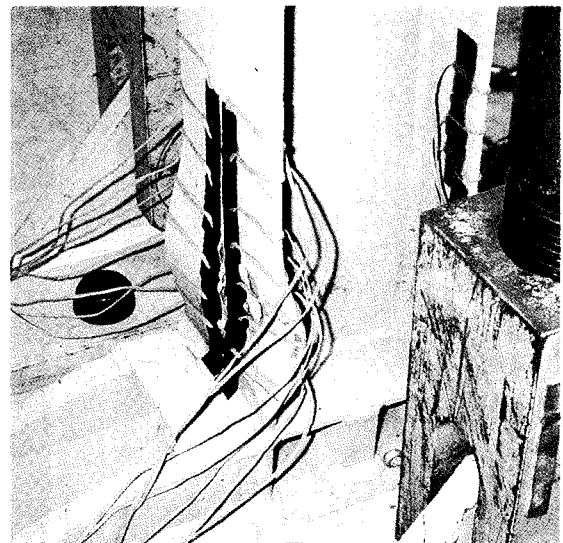

(b) Scaled model

Fig. 5 Test specimens attached with strain gauges

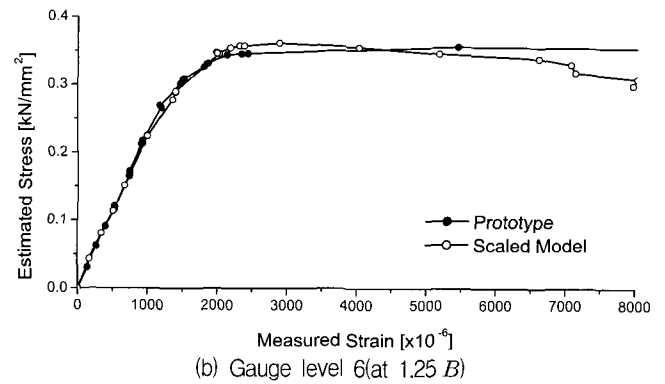
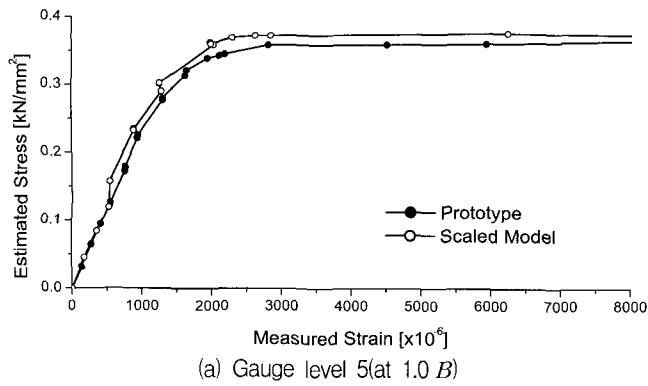

Fig. 6 Stress-strain curves at the location of FR

with this phenomenon. The above results are nearly identical and particularly the higher yield stress on the scaled model is not examined. Thus, it can be observed that there is no evidence of material-based size effect in the test specimens. Stress-strain curves obtained from the quasistatic tests and the tensile coupon tests are compared in Fig. 7.

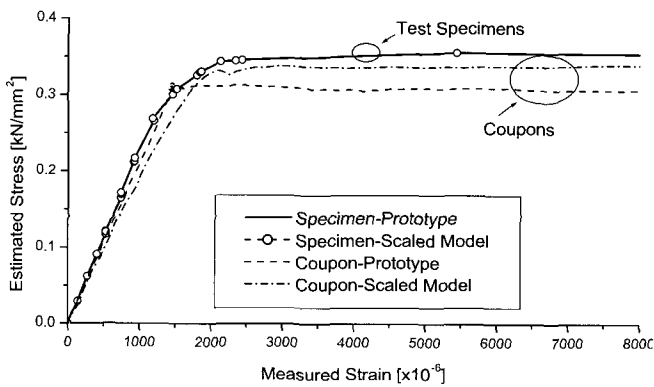

Fig. 7 Comparison of stress-strain curves on both specimens and coupons

4. Pseudodynamic Test

4.1 Verification of three similitude laws

To verify the feasibility of three similitude laws presented in Table 1, pseudodynamic tests were performed with the same specimens used in the quasistatic tests. The earthquake accelerogram used as an input load is two-times intensity of the 1940 El Centro earthquake(N-S Component) record shown in Fig. 8. As one of previous researchers, Kumar, et al.⁽⁹⁾ conducted an experimental study on concrete-filled steel pier specimens, using both mass-based and time-based similitude laws. They made a conclusion that the responses of each similitude law are not different if the same scale factors for length and force are employed in designing the scaled models.

This study expands the previous works to compare three similitude laws in Table 1, which also have the same scale factors for length and force. Thus, the pseudodynamic tests

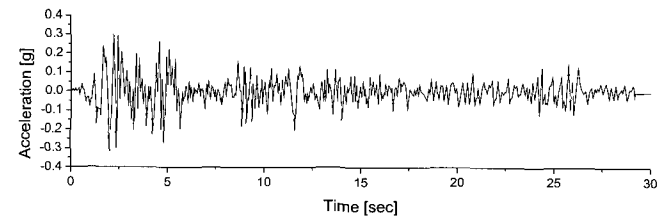

Fig. 8 The 1940 El Centro earthquake ground acceleration(PGA ≈0.349g)

are carried out entirely on the equation of motion for the scaled models as given in Eq. (1).

$$M_m a_m(t) + C_m v_m(t) + R_m(t) = -M_m a_{gm}(t) \quad (1)$$

where M_m means mass of the scaled model, C_m damping coefficient, $R_m(t)$ restoring force, $a_m(t)$ acceleration response, $v_m(t)$ velocity response and $a_{gm}(t)$ earthquake ground acceleration, respectively. During the pseudodynamic test, a corresponding restoring force $R_m(t)$ is measured from specimens and used to solve the equation of motion.

The test results of three similitude laws are presented in Fig. 9. From the comparison of pseudodynamic test results, it can be confirmed that the inelastic responses are practically coincident, when the same scale factors for length and force are used even in different similitude laws.

4.2 Comparison of prototype and scaled model

Due to stiffness distortion induced from fabrication errors and test setup conditions, fundamental frequencies on the specimens were varied with their stiffness reductions. Consequently, it is difficult to directly compare the test results from the prototype and the scaled model because there may be a phase shift in the inelastic responses. Seismic responses of the prototype and the scaled model are compared in Fig. 10. It can be unreasonable that the seismic performance of prototype structures is evaluated from the scaled models which may have a distorted stiffness inevitably.

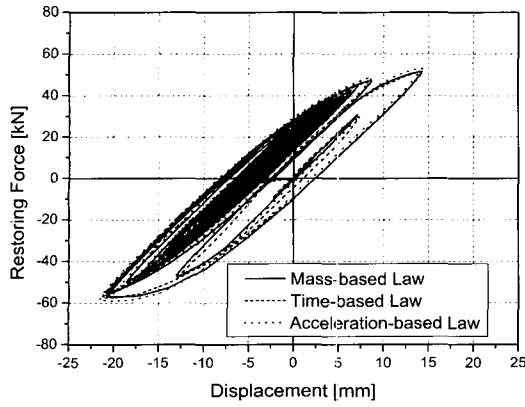

(a) Hysteretic loops

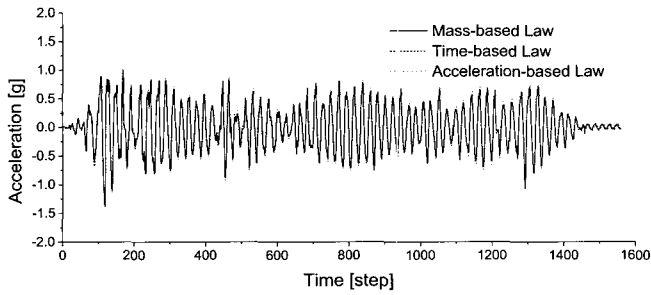

(b) Acceleration responses

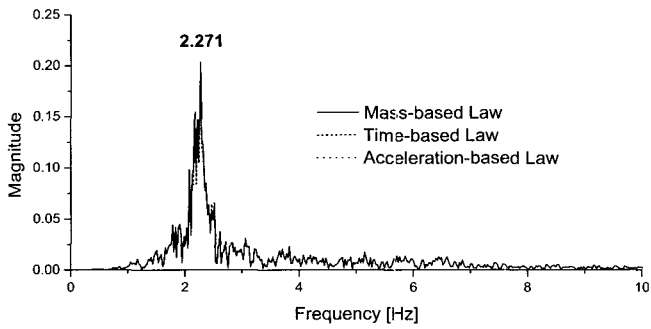

(c) Power spectra

Fig. 9 Pseudodynamic test results of scaled models using three similitude laws

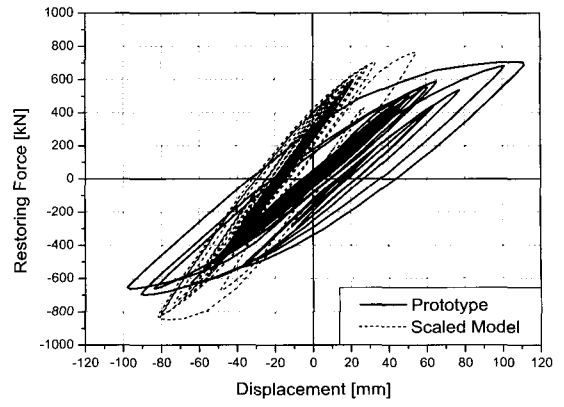

(a) Hysteretic loops

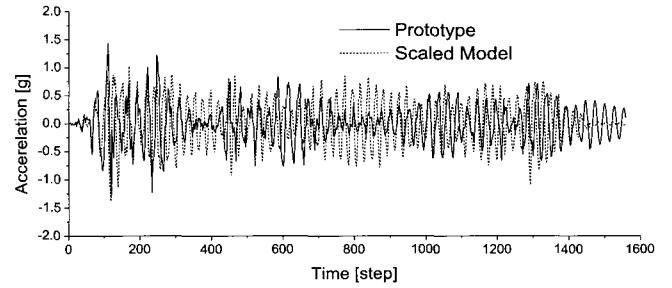

(b) Acceleration responses

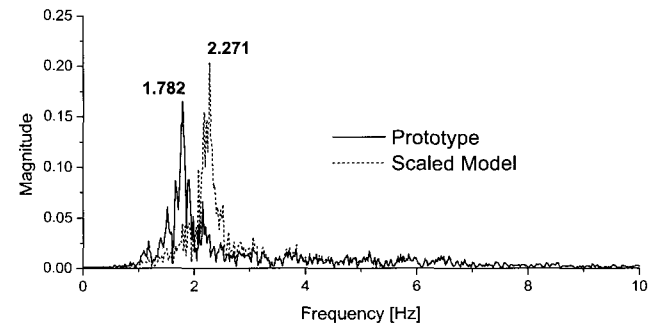

(c) Power spectra

Fig. 10 Pseudodynamic test results of prototype and scaled model by using the conventional similitude law

5. Modified Similitude Law

In the scaled model test, it is not easy to avoid stiffness distortion of specimens. Thus, most of experimental errors including the testing procedure can affect the stiffness distortion of specimens. Also, it is difficult for the scaled model to precisely simulate the boundary conditions of prototype.

To compensate the experimental errors, a scale factor for stiffness, S , can be substituted by a stiffness ratio, S^* , which means the measured elastic stiffness ratio of prototype to scaled model. Therefore, it is desirable that a stiffness ratio, S^* , is considered to compensate the scaled model in order to estimate the seismic performance of prototype properly. Defining a stiffness ratio as S^* , a scale factor for force can be modified as given in Eq. (2).

$$F_p = K_p \cdot \delta_p = S^* K_m \cdot S \delta_m = S^* S \cdot K_m \delta_m = S^* S \cdot F_m \quad (2)$$

The subscripts, p and m , mean quantities of prototype and scaled model, respectively. And the subscript, r , means a quantitative ratio of prototype to scaled model. In this way, using S and S^* , modified scale factors for acceleration and frequency can be expressed as Eqs. (3) and (4).

$$\begin{aligned} a_r &= \frac{a_p}{a_m} = \frac{F_p/M_p}{F_m/M_m} = \frac{F_p}{F_m} \frac{M_m}{M_p} \\ &= S^* S \cdot \frac{1}{S^2} = S^* S^{-1} \end{aligned} \quad (3)$$

$$\begin{aligned} f_r &= \frac{f_p}{f_m} = \sqrt{\frac{K_p/M_p}{K_m/M_m}} = \sqrt{\frac{K_p}{K_m} \frac{M_m}{M_p}} \\ &= \sqrt{S^* \cdot \frac{1}{S^2}} = S^{*0.5} S^{-1} \end{aligned} \quad (4)$$

Based on a stiffness ratio, S^* , the other quantities derived are summarized in Table 4. The modified similitude law proposed in this study has a problem that a scale factor for stress may not be unity. It is reasoned from the experimental errors that a scale factor for length, S , could not be equal to a stiffness ratio, S^* . However, considering the difficulties in matching the stiffness ratio to S , the modified similitude law may be more appropriate in an engineering perspective.

Table 4 Modified similitude law considering stiffness ratio

| Quantities | Scale Factors | Quantities | Scale Factors |
|-----------------|-------------------|--------------------|---------------------|
| Force F_r | $S^* S$ | Acceleration a_r | $S^* S^{-1}$ |
| Time T_r | $S^{*-0.5} S$ | Velocity v_r | $S^{*0.5}$ |
| Frequency f_r | $S^{*0.5} S^{-1}$ | Stress σ_r | $S^* S^{-1} \neq 1$ |

5.1 Compensation of stiffness distortion

When frequency shift is caused by stiffness distortion, it is difficult to directly compare the test results of prototype and scaled model with distorted dynamic properties. By compensation considering the stiffness ratio, the elastic stiffness of the scaled model can be similar to one of the prototype.

From Fig. 11(a), it is shown that the scaled model uncompensated has 8 to 13 percent of higher yield stress than the prototype. On the other hand, the scaled model compensated on stiffness distortion has much similar yield stress to the prototype. However, as a failure of local buckling after yielding happens, post-elastic stiffness on the scaled model is deviated from the prototype.

Comparing energy dissipation capacities of the quasistatic test results in Fig. 11(a), cumulative hysteretic energy, E_h , can be obtained from Eq. (5) given by

$$H_i = \sum_{i=1}^n F_i^* \Delta U_i \quad (5)$$

where

$$F_i^* = (F_i + F_{i+1})/2; F_i = \text{the } i \text{ th force}; \Delta U_i = \delta_{i+1} - \delta_i; \delta_i = \text{the } i \text{ th displacement}; \text{ and } n = \text{number of steps.}$$

From Fig. 11(b), it is shown that compensating elastic stiffness distortion could reduce the difference of energy dissipation capacities between the prototype and the scaled model.

A simulation study is conducted numerically using a bilinear hysteretic model in order to investigate the influence of stiffness distortion. The inelastic responses of a target system with design stiffness and a distorted system with stiffness degradation of 10% are converted to cumulative hysteretic energy and then compared in Fig. 12. In this figure,

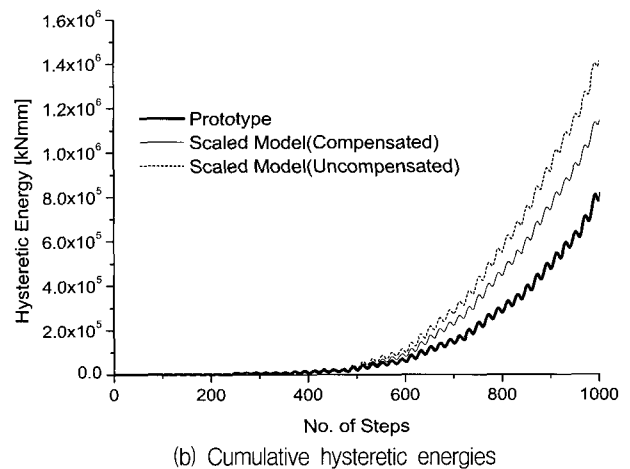
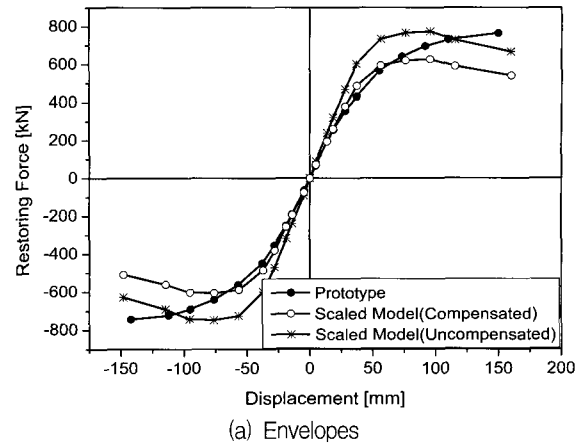

Fig. 11 Compensation of the quasistatic test results by considering stiffness ratio

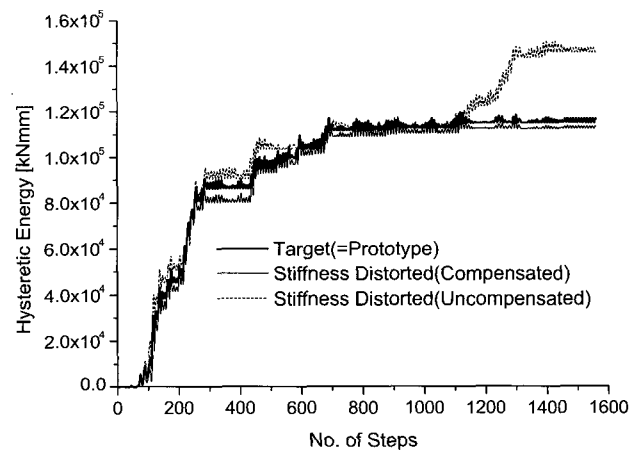

Fig. 12. Numerical simulation results with stiffness degradation of 10%

it is shown that the inelastic response of the distorted system can be effectively compensated, considering the stiffness ratio of target system to distorted system.

The inelastic response compensated is nearly close to the behavior of target system although there are some differences due to stiffness degradation. However, the inelastic response uncompensated shows that cumulative hysteretic energy in the distorted system is not comparable with the target system.

5.2 Verification test of modified similitude law

Based on the modified similitude law proposed in this study, the pseudodynamic test was carried out using the scaled model, of which scale factors for dynamic parameters are adjusted depending on the measured elastic stiffness ratio, S^* . Thus, the scaled model compensated by the modified similitude law can be applied to the pseudodynamic test algorithm.

In this test, the elastic stiffness ratio of 3.13, which corresponds to stiffness degradation of 17.4 percent, was obtained experimentally from the specimen used. According to the modified similitude law in Table 4, the elastic stiffness ratio obtained was applied to modify the scaled model in the pseudodynamic test algorithm. Then, the seismic responses on the scaled model were converted to the prototype.

According to pseudodynamic test results shown in Fig. 13, the seismic responses of the scaled model compensated are much improved as compared with the uncompensated results. Overall, it is confirmed that the modified similitude law considering stiffness ratio could be effective in simulating the seismic response of prototype structures.

6. Conclusions

In this study, consistency of three similitude laws based on mass, time or acceleration, respectively, are verified by the pseudodynamic scaled model tests under the same scale factors for length and force. From the comparisons of pseudodynamic test results with three similitude laws, it can be confirmed that the inelastic responses are practically coincident, when the same scale factors for length and force are used even in different similitude laws.

And a modified similitude law considering both a scale factor for length and a stiffness ratio is proposed. It can compensate the seismic response of scaled models and then make more reliable for the seismic performance resulted from the scaled model tests. Overall, it is confirmed that the modified similitude law considering stiffness ratio could be effective in simulating the seismic response of prototype structures. Also, this application provides an opportunity to use the results in designing the scaled models for shaking table tests.

Acknowledgements

This research was supported by the Korea Earthquake Engineering Research Center(KEERC) under Grant No. R11-19970450001902002. The authors wish to express their gratitude for the financial support.

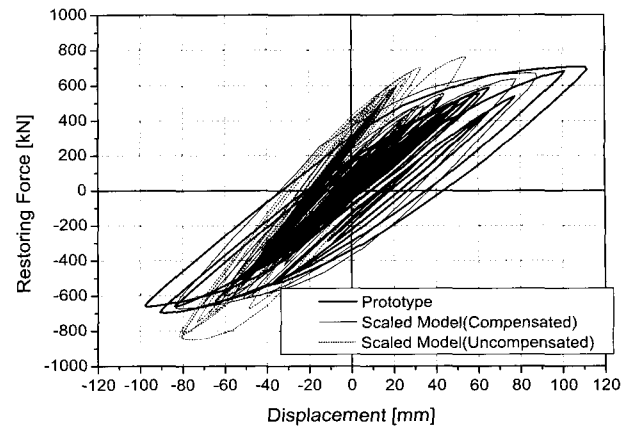

(a) Hysteretic loops

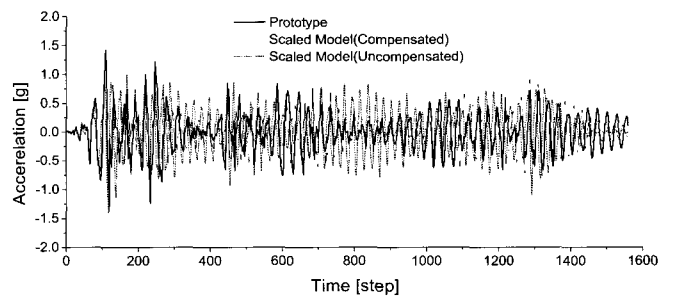

(b) Acceleration responses

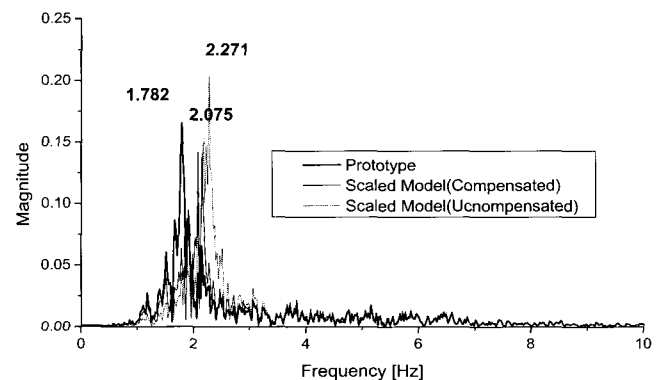

(c) Power spectra

Fig. 13 Pseudodynamic test results by using the modified similitude law

References

1. Richards, C. W., "Size effect in the tension test of mild steel beams," *Proc. of ASTM*, Vol. 54, 1954, pp. 995-1002.
2. Zhang, M. Z., "Study on similitude laws for shaking table tests," *Chinese Earthquake Engineering and Engineering Vibration*, Vol. 17, No. 2, 1997(in Chinese).
3. Zhang, M. Z., Guo, X. and Dai, J. W., "Shaking table tests of a high-rise building model," *Proc. of the Fifth International Conference on Tall Buildings*, Hong Kong, 1998.
4. Meng, Q. L., "The dynamic simulation of nonlinear performance of R/C structures in the earthquake simulation shaking table test," Master dissertation of Institute of Engineering Mechanics, China Seismological Bureau, Harbin, 2001.

5. Kim, W., El-Attar, A., and White, R. N., "Small-scale modeling techniques for reinforced concrete structures subjected to seismic loads," *Technical report NCEER-88-0041*, State University of New York at Buffalo, New York, 1988.
6. Lu, Y., Vintzileou, E., Zhang, G. F., and Tassios, T. P., "Reinforced concrete scaled columns under cyclic actions," *Soil Dynamics and Earthquake Engineering*, Vol. 18, 1999, pp. 151-167.
7. Mahin, S. A. and Shing, P. B., "Pseudodynamic test method-current status and future directions," *Journal of Structural Engineering*, ASCE, Vol. 115, No. 8, 1989, pp. 2113-2128.
8. Usami, T. and Kumar, S., "Damage evaluation in steel box columns by pseudodynamic tests," *Journal of Structural Engineering*, ASCE, Vol. 122, No. 6, 1996, pp. 635-642.
9. Kumar, S., Itoh, Y., Saizuka, K. and Usami, T., "Pseudodynamic testing of scaled models," *Journal of Structural Engineering*, ASCE, Vol. 123, No. 4, 1997, pp. 524-526.
10. Zung, Z. M., Chang, S. P., and In, S. B., "The seismic performance for concrete-filled steel piers," *Proceedings of Earthquake Engineering of Korea*, Vol. 6, No. 2, 2002, 9, pp. 189-196(in Korean).
11. Kim, N. S. and Lee, D. G., "Pseudodynamic test for evaluation of seismic performance of base-isolated liquid storage tanks," *International Journal of Engineering Structures*, Vol. 17, No. 3, 1995, pp. 198-208.
12. Chung, W. J., Yun, C. B., Kim, N. S., and Seo, J. W., "Shaking table and pseudodynamic tests for the evaluation of the seismic performance of base-isolated structures," *International Journal of Engineering Structures*, Vol. 21, 1999, pp. 365-379.
13. Harris, H. G. and Sabnis, G. M., *Structural modeling and experimental techniques*, CRC Press, New York, 1999.
14. Korean Standard Handbook, Steel(I), KSA, 2001.
15. Annual book of ASTM standards, Section 1, Vol. 01.04, ASTM, 1992.