

## A Study on Pressure Drop Characteristics of Refrigerants in Horizontal Flow Boiling

**Tae Woo Lim\*, Kyu Il Han**

*School of Mechanical Engineering, Pukyong National University,  
San 100, Yongdang-Dong, Nam-Gu, Busan 680-739, Korea*

An experimental investigation on the flow pattern and pressure drop was carried out for both an adiabatic and a diabatic two-phase flow in a horizontal tube with pure refrigerants R134a and R123 and their mixtures as test fluids. The observed flow patterns were compared to the flow pattern map of Kattan et al., which predicted well the present data over the entire regions of mass velocity in this study. The measured frictional pressure drop in the adiabatic experiments increased with an increase in vapor quality and mass velocity. These data were compared to various correlations proposed in the past for the frictional pressure drop. The Chisholm correlation underpredicted the present data both for pure fluids and their mixtures in the entire mass velocity range of 150 to 600 kg/m<sup>2</sup>s covered in the measurements, while the Friedel correlation was found to overpredict the present data in the stratified and stratified-wavy flow region, and to underpredict in the annular flow region.

**Key Words :** Flow Pattern, Mixture, Pressure Drop, Two-Phase Frictional Multiplier

### Nomenclature

$D$  : Tube inner diameter (m)  
 $f$  : Friction factor  
 $g$  : Mass velocity (kg/m<sup>2</sup>s)  
 $L$  : Tube length (m)  
 $P$  : Pressure drop (Pa)  
 $q$  : Heat flux (W/m<sup>2</sup>)  
 $Re$  : Reynolds number  
 $X$  : Mole fraction in liquid  
 $Y$  : Mole fraction in vapor  
 $z$  : Axial distance (m)

### Greek Letters

$\alpha$  : Void fraction  
 $\beta$  : Vapor quality  
 $\rho$  : Density (kg/m<sup>3</sup>)  
 $\mu$  : Viscosity (Pa s)  
 $\Phi$  : Two-phase frictional multiplier

### Subscripts

$a$  : Acceleration  
 $f$  : Friction  
 $f_o$  : Total flow assumed as liquid  
 $i$  : Inlet of the heat transfer section  
 $l$  : Liquid  
 $o$  : Outlet of the heat transfer section  
 $TP$  : Two-phase  
 $v$  : Vapor

## 1. Introduction

In the past decade, experimental studies and empirical and predictive methods were carried out for two-phase pressure drop in tubes, which is an essential element for the design of efficient heat exchanger such as refrigeration and air-conditioning systems. As a result of these efforts, a large number of empirical correlations for two-phase pressure drop in horizontal tube are available, but most of the correlations for the pressure drop were developed based on water-steam or water-air mixtures. Thus, these correlations are difficult to be applied to refrigeration mixtures because the

---

\* Corresponding Author,  
**E-mail :** kyunlim@hanmail.net  
**TEL :** +82-51-620-1581; **FAX :** +82-51-620-1574  
 School of Mechanical Engineering, Pukyong National University, San 100, Yongdang-Dong, Nam-Gu, Busan 608-739, Korea. (Manuscript **Received** August 9, 2002; **Revised** February 5, 2003)

two-phase flow phenomenon in water-air systems is different from that of refrigeration systems. This may be significantly affected by the fluid properties. Surface tension particularly makes the fluid to minimize its interfacial area. Since the surface tension of water-air is much larger than that of R134a/R123, the flow resistance for fluids having higher contact angle (that is, such as water) is expected to be smaller as reported by Barajas et al. (1993). Conversely, for fluids having smaller contact angle (that is, such as refrigerants), the flow resistance becomes higher.

The measured total pressure drop during two-phase flow boiling consists of the sum of two components, that is, frictional pressure drop and pressure drop due to acceleration. The frictional pressure drop is the most difficult component to predict, and makes the most important contribution to the total pressure drop. On the other hand, the acceleration pressure drop resulting from the variation of the momentum flux caused by phase change is generally small as compared to the frictional pressure drop. The frictional pressure drop during flow boiling is predicted by using two ways: the homogeneous model (1994) assuming equal phasic velocities and the separate model referred to as a slip flow model.

Pierre (1966), based on the homogeneous model, developed the correlation from the measured pressure drop data with R12, R22 and R502. The separate model started from Lockhart and Martinelli (1949) is connected to Martinelli and Nelson (1948) used widely to predict the pressure drop during horizontal flow boiling. Jung et. al. (1989) performed an experimental study on pressure drop during horizontal flow boiling of pure and mixed refrigerants of R22, R114, R12, and R152a, and developed a new correlation with a mean deviation of 8.4% by modifying Martinelli and Nelsons correlation. The two-phase multiplier, in the two-phase pressure drop correlation of Jung et. al., was expressed as a function of reduced pressure at various qualities. As suggested by Jung et. al., their results indicated no composition dependence of pressure drop with mixed refrigerants.

As suggested in Hosler (1968), knowing the

flow pattern in two-phase flow is analogous in single-phase flow to knowing whether the flow is turbulent or laminar. This means that the pressure drop is closely related to the flow pattern.

The objectives of the present study are to obtain the experimental data for flow pattern and pressure drop during flow boiling in horizontal tube with pure refrigerants R134a, R123 and their mixtures. From the result obtained in this study, we are to elucidate the transition quality to annular flow in flow pattern and pressure drop characteristics with respect to vapor quality and mass velocity in pressure drop, and finally to compare the present data with existing various correlations for pressure drop.

## 2. Experimental Apparatus and Procedure

The experimental apparatus used in the present study is schematically shown in Figure 1. The circulation loop of test fluid consists of a reservoir tank, pump, flow meters, mixing chambers, preheaters, sight glass sections, the test section, condenser and other accessories.

Subcooled fluid in the reservoir tank is pumped through a strainer and the 1st preheater to the inlet mixing chamber where fluid temperature and pressure are measured. Then the fluid is heated in the 2nd preheater up to a prescribed enthalpy or vapor quality and then enters the heated test

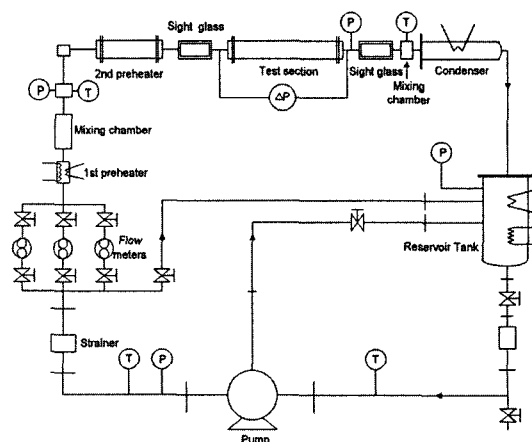

Fig. 1 Experimental apparatus

section where the fluid evaporates inside the tube wall heated at uniform heat flux. Flow patterns of boiling two-phase fluid are observed at the upstream and downstream of the test section through glass tube of the same diameter as the test tube. Visual observations were conducted with the high-speed camera through the sight glass tube downstream of the heated section. The images recorded were replayed by the slow motion so as to make the flow patterns discriminated clearly.

Figure 2 shows the test section, a 3 m-long stainless steel tube of 10 mm I. D. and 1.5 mm wall thickness, the central 2 m of which is the heat transfer section and is heated by directly passing stabilized AC that is supplied from a low-voltage and high-current transformer. Electric heating is allowed so as to supply a constant heat flux to the fluid flowing inside the tube along a fixed tube length of 2-m. Also, a desired quality at the inlet of the test section can be obtained by adjusting heat supply at the 2nd preheater. Although the test section and preheater are well insulated with glass fiber, heat loss in the heated test section is inevitable. It was calibrated as a function of the temperature difference between the tube wall and ambient room air, and used in the evaluation of tube inside temperature and heat flux.

The fluid temperature and pressure are measured in the mixing chambers at the inlet and exit of the test section. The pressure drop between the inlet and exit of the test section are measured using differential pressure transducer. The pressure taps are closely installed to the heated section (namely, 15 mm apart from both ends), and con-

nected to the pressure transducer. These data of fluid temperature and pressure are used to determine the local fluid temperature and pressure along the test section.

Refrigerants R134a and R123 are selected as test fluids of pure components. They are respectively mixed as the more- and less-volatile components to constitute binary mixtures. Thermodynamic properties of pure refrigerants and their mixtures were calculated using the modified Benedict-Webb-Rubin equation of state with fifteen constant (1977), and transport properties using the method recommended by Reid et al. (1977). In the present experiment, the mass velocity is set at 150, 225, 300 and 600 kg/m<sup>2</sup>s, and heat flux is varied at 5, 10, 20 and 50 kW/m<sup>2</sup>. Vapor quality covers zero to almost unity.

### 3. Flow Pattern

Flow patterns in the present experiments are observed through the sight glass tube downstream of the heated section. Observed flow patterns are classified into intermittent (I), stratified (S), stratified-wavy (SW), annular (A) and coexistence of stratified-wavy and annular flow (SW/A). Here, the intermittent flow includes slug and plug flow.

Visual observations were conducted with the high-speed camera through the sight glass tube downstream of the heated section. The images recorded were replayed by the slow motion so as to make the flow patterns discriminated clearly.

Figure 3 shows typical pictures of the observed flow patterns for mass velocity from 150 to 600 kg/m<sup>2</sup>s. Flow pattern data classified in this study are plotted on the mass flux versus quality map of Fig. 4. The boundaries of respective flow patterns in the figure are by given Kattan et al. (1998). They modified the VDI (Steiner, 1993) flow pattern map to develop a new map applied for evaporation in horizontal tubes, based on flow pattern data for five different refrigerants covering a wide range of mass flux and vapor quality. As seen in Fig. 4 the present data for mixtures are well predicted by flow map of Kattan et al. The transition quality from intermittent to annular

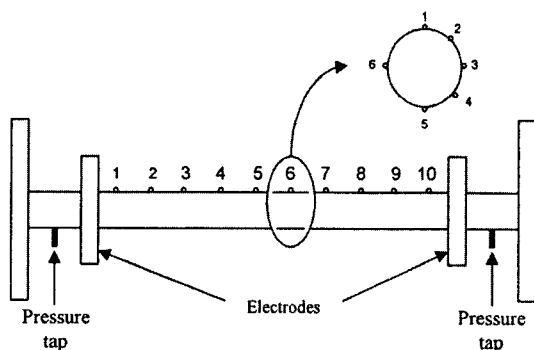

Fig. 2 Test section

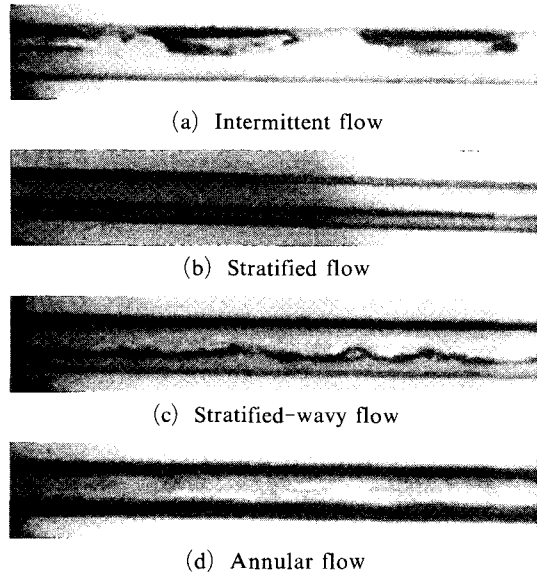

Fig. 3 Typical pictures of flow patterns

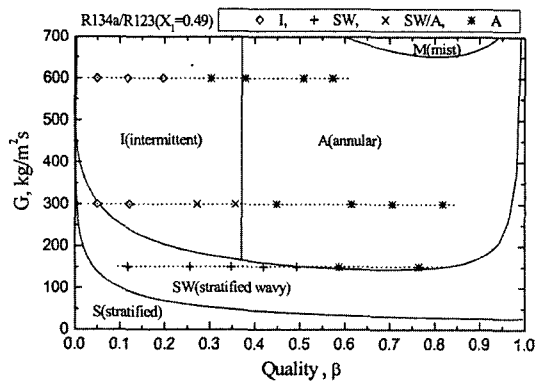

Fig. 4 Flow patterns on the  $G$ - $\beta$  map

flow in Kattan et al. map is found to constant with approximately 0.37 at  $G > 150$  kg/m<sup>2</sup>s. According to the result observed in this study, the transition quality to annular flow was shown to be gradually getting smaller as the mass velocity was increased.

#### 4. Results and Discussion

##### 4.1 Pressure drop

Total pressure drop in a tube during horizontal flow boiling consists of the sum of two components given by

$$\Delta P = \Delta P_f + \Delta P_a \quad (1)$$

where  $\Delta P_f$  is the frictional pressure drop and  $\Delta P_a$  is the acceleration pressure drop. The measured pressure drop, under the adiabatic (no heating) condition of the test section, indicates the frictional pressure drop because the acceleration pressure drop is negligible when the test section is fully insulated. Vapor quality at the test section inlet was varied by adjusting the power supplied the preheater. This adiabatic experiment can only obtain the frictional pressure drop data without considering the loss due to acceleration in the measured pressure drop.

##### 4.2 Adiabatic pressure drop

The pressure drop measured under the adiabatic condition of test section can be expressed in the form of the pressure gradient against the inlet quality as shown in Fig. 5. It is seen from the figure that the pressure drop increases with an increase in vapor quality and mass flux. The variation of pressure drop, as the quality is increased, has a similar pattern for both pure refrigerants and their mixtures.

Generally, the two-phase frictional multiplier is used to predict the frictional pressure drop during the two-phase flow boiling, and can be represented as

$$\phi_{fo}^2 = \frac{\Delta P_{TP}}{\Delta P_{fo}} \quad (2)$$

where  $\Delta P_{TP}$  is the measured two-phase frictional pressure drop and  $\Delta P_{fo}$  is the frictional pressure drop if the flow through the horizontal tube is all liquid. Thus

$$\Delta P_{fo} = \frac{2f_{fo}G^2L}{D\rho_l} \quad (3)$$

Here the friction factor for turbulent flow is given as

$$f_{fo} = 0.079Re^{-1/4} \quad (4)$$

Figure 6 shows the variation of the multipliers calculated from the measured two-phase frictional pressure drops in equation (2) for mass velocity from 150 to 600 kg/m<sup>2</sup>s. Fig. 7 indicates the comparison between the measured two-phase multiplier and several typical correlations. As seen in the figure the compared correlations vary

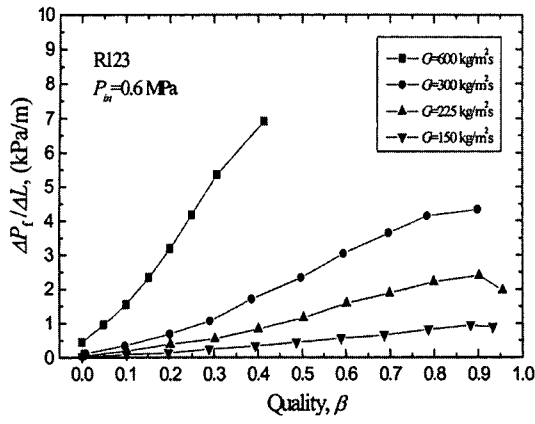

(a) Pure refrigerant

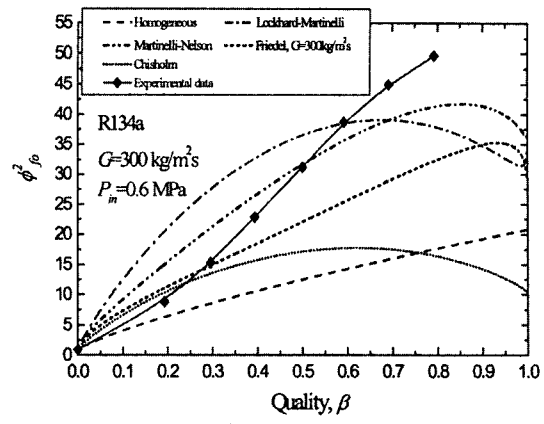

(a) R134a

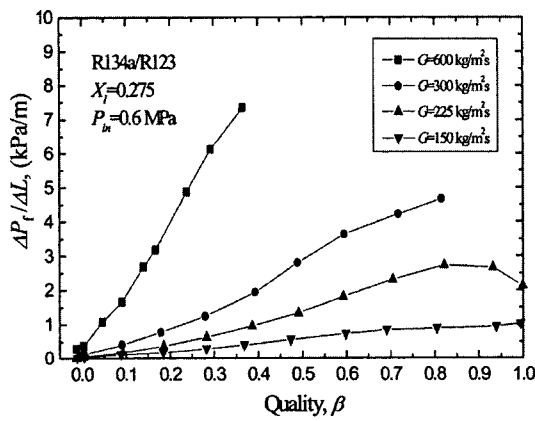

(b) Mixture

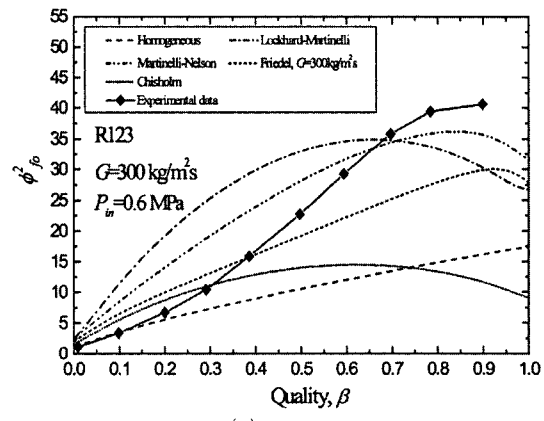

(b) R123

Fig. 5 Variations of pressure gradient against quality

Fig. 7 Comparison between the measured frictional multiplier and several correlations

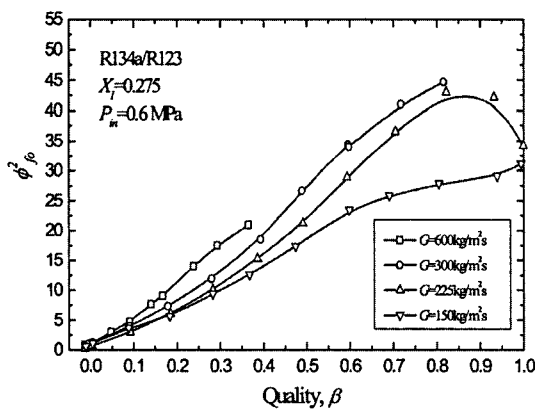

Fig. 6 Variations of the two-phase frictional multipliers against quality

tions. The Friedel correlation lies to the middle of other correlations with a nearly linear variation, whereas the Lockhart-Martinelli and Martinelli-Nelson correlations show the larger value with a non-linear variation as compared with other correlations. The correlation of Friedel, among those mentioned above, was found to correlate satisfactorily the present data for the two-component although originally derived based on single-component two-phase flow. This model, however, overpredicted relatively the present data for both pure refrigerants and their mixture at low quality, and underpredicted at high quality. In Fig. 7, namely, the present data positioned at the lower side of the Friedel correlation correspond to the stratified and stratified-wavy flow region. Those at the upper side, on the other hand, correspond

quite widely. The homogeneous flow model shows the much smaller value than other correla-

to the annular flow region.

**4.3 Diabatic pressure drop**

The two-phase frictional pressure drop multiplier with a change of quality from  $\beta_i$  to  $\beta_o$  over a heated length  $L$  can be calculated from Eq (2) as

$$\frac{\overline{\phi}_{fo}^2}{\overline{\phi}_{fo}^2} = \frac{\Delta P_{TP}}{\Delta P_{fo}} = \frac{1}{\beta_o - \beta_i} \int_{\beta_i}^{\beta_o} \phi_{fo}^2 dx \quad (5)$$

Fig. 8 shows typical results of the measured total pressure drops for various values of heat flux at an instant inlet quality of 0.1 with  $G=300 \text{ kg/m}^2\text{s}$ . The acceleration pressure drop in the figure under the heated condition is evaluated from the following equation.

$$\Delta P_a = G^2 \left[ \left\{ \frac{\beta^2}{\alpha \rho_v} + \frac{(1-\beta)^2}{(1-\alpha) \rho_l} \right\}_{out} - \left\{ \frac{\beta^2}{\alpha \rho_v} + \frac{(1-\beta)^2}{(1-\alpha) \rho_l} \right\}_{in} \right] \quad (6)$$

where the void fraction  $\alpha$  is calculated using CISE (1970) correlation although there is a wide deviation between various correlations of void fraction as illustrated in Fig. 9. The CISE correlation used in this study is owing to being the most accurate, generally applicable correlation for slip ratio, and also reflecting the effect on mass flux, as indicated in Whalley (1987). As shown in the figure, the acceleration pressure drop is not significant at low quality. As quality is increased, the acceleration pressure drop accounts for approximately 30 percent of the total pressure drop.

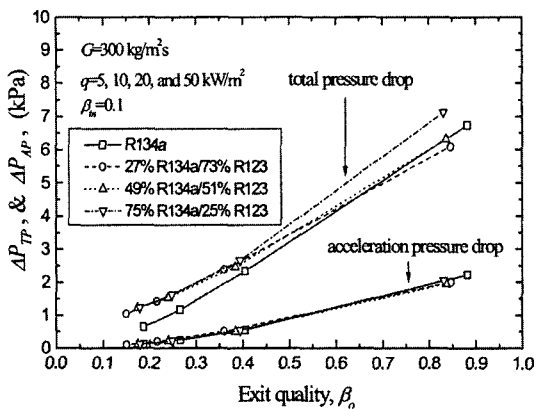

Fig. 8 Variations of the total and acceleration pressure drops as a function of the exit quality

Fig. 10 indicates the comparisons between the measured frictional pressure drop for pure refrigerants and their mixtures and those calculated using the correlation of Friedel (1979). In the same way as in the adiabatic flow condition, the Friedel correlation overpredicted the present data in the stratified and stratified-wavy flow region by about 20%, and it underpredicted in the annular flow region by about 20%. The Chisholm (1973) correlation underpredicted the frictional pressure drop for mixtures as well as pure refrigerants in the entire mass flux ranges employed in this study. Homogeneous model, also, considerably under-predicted the present data for the entire range of mass flux and quality. Table 1 lists

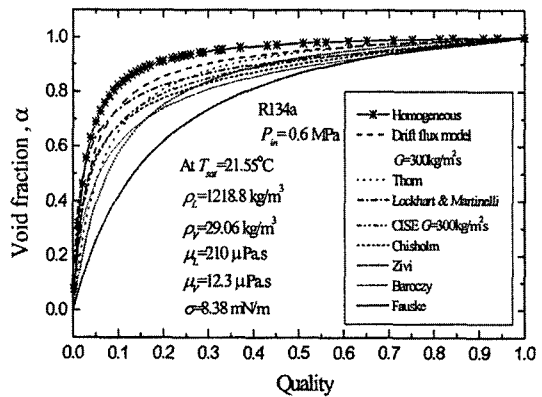

Fig. 9 Variations of the void fraction predicted from various correlations

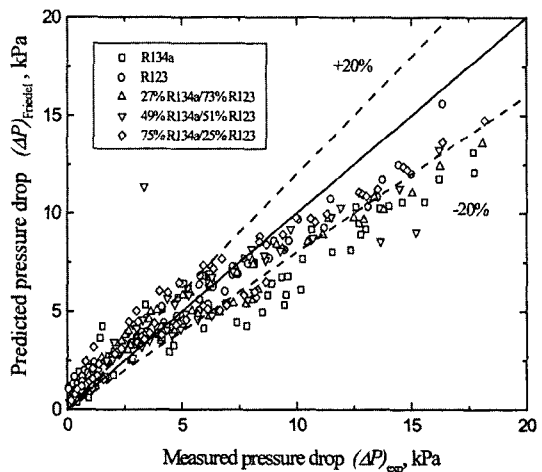

Fig. 10 Comparison between measured data and Friedel correlation

**Table 1** Comparison of percentage deviation between the available correlations and the present data

Refrigerants	Homogeneous		Friedel		Chisholm	
	Mean	Ave.	Mean	Ave.	Mean	Ave.
27%R134a/73%R123	33.3	-30.4	33.9	18.9	31.2	1.4
49%R134a/51%R123	37.1	-22.7	46.5	32.3	40.7	14.1
75%R134a/25%R123	36.1	-28.8	43.7	31.5	34.5	4.4
R134a	46.7	-38.7	38.1	4.5	43.3	-5.9
R123	48.8	-22.7	47.2	37.8	47.9	13.8

the mean deviation and the average deviation obtained with a few correlations. As explained in Fig. 7, the Friedel correlation predicted well the present data for the frictional pressure drop for both pure refrigerants and their mixture in the entire region of quality, but it failed to correlate the pressure drop data in the stratified-wavy and annular flow region. It, also, was found to consider two-phase effects mentioned in Fig. 7, because of including the effect of surface tension and gravity by using the Froude and Weber Numbers. Accordingly, if a modification to the Friedel correlation is made, the present data will be more exactly predicted by the correlation.

## 5. Conclusions

An experimental study on the two-phase frictional pressure drop during flow boiling of pure refrigerants R134a and R123, and their mixtures were performed in a uniformly heated horizontal tube. Based on the measured data, the following conclusions were reached.

(1) In an adiabatic experiment, the measured frictional pressure drop increased with an increase in vapor quality and mass flux. No particular difference between pure refrigerants and mixtures with composition was found in the pressure drop of the two-phase flow boiling.

(2) In a diabatic experiment, the frictional pressure drop was obtained by subtracting the acceleration pressure drop in total pressure drop. The acceleration pressure drop was not very significant at low quality, but accounted for approximately 30 percent of total pressure drop at high quality.

(3) The Friedel correlation predicted well the

frictional pressure drop for both pure refrigerants and their mixtures, but it overpredicted the present data in the stratified and stratified-wavy flow region, and underpredicted in the annular flow region. The Chisholm correlation underpredicted the present data for the entire mass flux ranges employed in this study.

## References

- Barajas, A. M. and Panton, R. L., 1993, The Effects of Contact Angle on Two-Phase Flow in Capillary Tubes, *Int. J. Multiphase Flow*, Vol. 19, pp. 337~346.
- Chisholm, D., 1973, Pressure Gradients Due to Friction During the Flow of Evaporating Two-Phase Mixtures in Smooth Tubes and Channels, *Int. J. Heat Mass Transfer*, Vol. 16, pp. 347~358.
- Collier, J. G. and Thome, J. R., 1994, *Convective Boiling and Condensation*, 3rd Edition. Oxford University Press, London.
- Friedel, L., 1979, Improved Friction Pressure Drop Correlations for Horizontal and Vertical Two-Phase Pipe Flow, Presented at the European Two-phase Flow Group Meeting, Ispra, Italy, Paper E2, June, Vol. 18, pp. 485~492.
- Hosler, E. R., 1968, Flow Patterns in High Pressure Two Phase (Steam-Water) Flow with Heat Addition, *AIChE Symp. Ser.* Vol. 64, pp. 54~66.
- Jung, D. S. and Radermacher, R., 1989, Prediction of Pressure Drop During Horizontal Annular Flow Boiling of Pure and Mixed Refrigerants, *Int. J. Heat Mass Transfer*, Vol. 32, pp. 2435~2446.
- Kattan, N., Thome, J. R. and Favrat, D., 1998, Flow Boiling in Horizontal Tubes, Part I, *J. Heat*

Transfer, Vol. 120, pp. 140~147.

Lockhart, R. W. and Martinelli, R. C., 1949, Proposed Correlation of data for Isothermal Two-Phase, Two-Component Flow in Pipes, Chem. Engng. Prog. Vol. 45, pp. 39~48.

Martinelli, R. C. and Nelson, D. B., 1948, Prediction of Pressure Drop During Forced-Circulation Boiling of Water, Trans. ASME Vol. 70, pp. 695~702.

Nishiumi, H. and Saito, S., 1977, Correlation of the Binary Interaction Parameter of the Modified Generalized BWR Equation of State, J. Chem. Eng. Japan, Vol. 10, pp. 176~180.

Pierre, B., 1966, Flow Resistance with Boiling Refrigerants, ASHRAE Trans., pp. 28~42.

Premoli, A., Francesco, D. and Prina, A., 1970, An Empirical Correlation for Evaluating Two-

Phase Mixture Density Under Adiabatic Conditions, European Two-Phase Flow Group Meeting, Milan.

Reid, R. C., Prausnitz, J. M. and Sherwood, T. K., 1977, The Properties of Gases and Liquids, 3rd Edn., McGraw-Hill, New York.

Thom, J. R. S., 1964, Prediction of Pressure Drop During Forced Circulation Boiling of Water, Int. J. Heat Mass Transfer, Vol. 7, pp. 709~724.

VDI-Warmeatlas, 1993, Heat Transfer to Boiling Saturated Liquids, VDI Heat Atlas, Chapter Hbb1. Dusseldorf, Germany : VDI-Verlag GmbH (in English).

Whalley, P. B., 1987, Boiling, Condensation and Gas-Liquid Flow, Oxford University Press, New York.